Overvoltage Protector IC with Reverse Current Protection

NO.EA-313-181010

OUTLINE

The R5528Z001A is a CMOS-based overvoltage protector IC with reverse current protection that use an NMOS pass transistor to achieve ultra-low on resistance (Typ. 54mΩ). Overvoltage protection threshold is as high as 6.8V±3%. Also, continuous current capability is as high as 3A.

Internally, the R5528Z001A consists of a reverse current protection circuit, a soft-start circuit, a startup debounce circuit, an undervoltage lockout (UVLO) circuit, and a thermal shutdown circuit.

The R5528Z001A is offered in a small and thin WLCSP-9-P1 package which achieves the smallest possible footprint solution on boards where area is limited.

FEATURES

- Input Voltage Range (V_{IN}) 2.3V to 36V
- Output Current (I_{OUT}) Max. DC 3A
- Switch On Resistance (R_{ON}) 54mΩ ($V_{IN} = 5.0V, I_{OUT} = 100mA$)
- OVP Threshold Accuracy 6.8V±3%
- PG Function
- Reverse Current Protection Circuit
- Soft-start Circuit
- Startup Debounce Circuit 15ms
- Thermal Shutdown Circuit
- Package WLCSP-9-P1 (1.27 mm x 1.27 mm x 0.64 mm)

APPLICATIONS

- Smartphones, Tablet PCs
- Portable devices

BLOCK DIAGRAMS

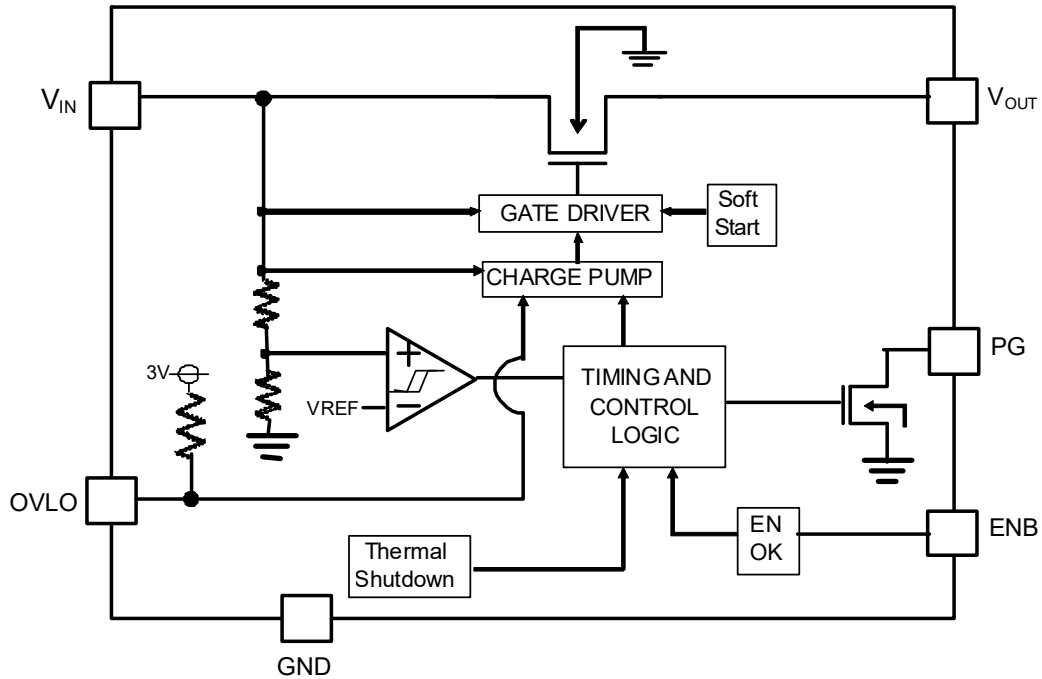

Figure 1. R5528Z001A

SELECTION GUIDE

Product Name	Package	Quantity per Reel	Pb Free	Halogen Free
R5528Z001A-E2-F	WLCSP-9-P1	5,000pcs	Yes	Yes

PIN CONFIGURATIONS

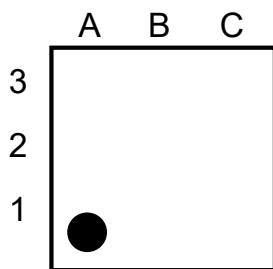

Figure 2. Top View

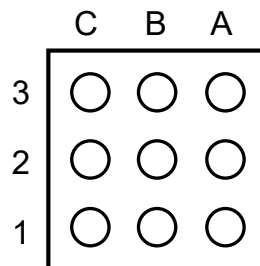

Figure 3. Bottom View

PIN DESCRIPTION

Pin No.	Symbol	Pin Description
A1	PG	Open Drain Flag Output Pin PG is driven low after input voltage is stable between minimum V_{IN} and $V_{IN-OVLO}$ after debounce (delay).
A2	OVLO	Overvoltage Lockout Input Pin Applying a voltage less than OVLO threshold (V_{OVLO_TH}) to the overvoltage lockout input pin can turn off a switch. When the overvoltage lockout input pin is Open, it outputs an OVLO open voltage (V_{OVLO_OP}).
A3	ENB	Active-Low ENB Input Pin
B1, C1	V_{IN}	Input Pin
B2	I.C	Internally Connected to Ground Unconnected or connected to GND
B3, C3	V_{OUT}	Output Pin
C2	GND	Ground Pin

ABSOLUTE MAXIMUM RATINGS

Symbol	Item	Rating	Unit
V_{IN}	Input Voltage	-0.3 to 40	V
V_{OUT}	Output Voltage	-0.3 to 8.0	V
V_{ENB}	ENB Pin Input Voltage	-0.3 to 6.5	V
V_{PG}	PG Pin Voltage	-0.3 to 6.5	V
V_{OVLO}	OVLO Pin Input Voltage	-0.3 to 6.5	V
I_{PG}	PG Pin Current	14	mA
I_{OUT}	Output Current	3.0	A
P_D	Power Dissipation (High Wattage Land Pattern)*1	1190	mW
T_{opt}	Operating Temperature Range	-40 to +85	°C
T_{stg}	Storage Temperature	-55 to +125	°C

*1 Refer to *POWER DISSIPATION* for detailed information.

ABSOLUTE MAXIMUM RATINGS

Electronic and mechanical stress momentarily exceeded absolute maximum ratings may cause the permanent damages and may degrade the life time and safety for both device and system using the device in the field. The functional operation at or over these absolute maximum ratings is not assured.

RECOMMENDED OPERATING CONDITIONS (ELECTRICAL CHARACTERISTICS)

All of electronic equipment should be designed that the mounted semiconductor devices operate within the recommended operating conditions. The semiconductor devices cannot operate normally over the recommended operating conditions, even if when they are used over such conditions by momentary electronic noise or surge. And the semiconductor devices may receive serious damage when they continue to operate over the recommended operating conditions.

ELECTRICAL CHARACTERISTICS

$V_{IN} = 2.3V$ to $36V$, $I_{OUT} = 1mA$, $C_{IN} = 1\mu F$, $C_{OUT} = 1\mu F$, unless otherwise noted. Typical values are $V_{IN} = 5V$ and $T_a = 25^\circ C$.
The specifications surrounded by are guaranteed by Design Engineering at $-40^\circ C \leq T_a \leq 85^\circ C$.

(Ta=25°C)

Symbol	Item	Conditions	Min.	Typ.	Max.	Unit
V_{IN}	Input Voltage		2.3		36	V
I_{IN}	Input Supply Current	$V_{ENB} = 0V$, $V_{IN} = 5V$, $I_{OUT} = 0mA$		50	120	μA
I_{IN_DIS}	Input Disable Current	$V_{ENB} = 0V$, $V_{IN} = 5V$, $V_{OVLO} = 0V$		40	120	μA
I_{IN_Q}	Input Shutdown Current	$V_{ENB} = 5V$, $V_{IN} = 5V$, $V_{OUT} = 0V$		1.0	12	μA
I_{OUT_DIS}	Output Disable Current	$V_{ENB} = 0V$, $V_{OUT} = 5V$, $V_{IN} = 5V$, $V_{OVLO} < V_{OVLO_TH}$			3	μA
		$V_{ENB} = 0V$, $V_{OUT} = 5V$, $V_{IN} > V_{IN_OVLO}$				
I_{OUT_SD}	Output Shutdown Current	$V_{ENB} = 5V$, $V_{OUT} = 5V$, $V_{IN} = 5V$			5.5	μA
R_{ON}	On Resistance	$V_{IN} = 5V$, $I_{OUT} = 100mA$		54	100	m Ω
V_{IN_OVLO}	Overvoltage Protection Threshold	V_{IN} rising	6.6	6.8	7.0	V
		V_{IN} falling	6.4			V
C_{OUT}	OUT Load Capacitance				1000	μF
V_{OVLO_OP}	OVLO Open voltage	$V_{ENB} = 0V$, $V_{IN} = 5.0V$		3.0	3.6	V
R_{OVLO_PU}	OVLO Pull-up Resistance			500		k Ω
V_{OVLO_TH}	OVLO Force Off Voltage		0.6	1.0	1.4	V
V_{IH}	ENB Input High Voltage		1.4			V
V_{IL}	ENB Input Low Voltage				0.4	V
I_{ENB}	ENB Input Leakage		-1		1	μA
V_{OL}	PG Output Low Voltage	$I_{SINK} = 1mA$			0.4	V
V_{PG_LEAK}	PG Leakage Current	$V_{IO} = 3.3V^{*2}$	-1		1	μA
t_{DEB}	IN Debounce Time	starts when $2.3V < V_{IN}(5V) < V_{IN_OVLO}$ and ends when charge-pump is turned on ^{*3}	10	15	35	ms
t_{SS}	Soft-start Time	starts when $2.3V < V_{IN} < V_{IN_OVLO}$ and ends when $V_{OUT} = 90\%$ of V_{IN}		30		ms
t_{ON}	Turn-on Time During Soft-start	$V_{IN} = 5V$, $R_L = 50\Omega$, $C_L = 10\mu F$, starts when $V_{OUT} = 20\%$ of V_{IN} and ends when $V_{OUT} = 80\%$ of V_{IN} ^{*3}	1.5	-		ms
t_{OFF}	Turn-off Time	$R_L = 50\Omega$, starts when $V_{IN} > V_{IN_OVLO}$ (2V/ μs) and ends when $V_{OUT} = 80\%$ of V_{IN}		1.5		μs
		starts when V_{ENB} is switched from "L" to "H", ends when $V_{OUT} = 80\%$ of V_{IN} , $R_L = 50\Omega$		84		
T_{SHDN}	Thermal Shut Down			150		$^\circ C$
T_{HYST}	Thermal Hysteresis			20		$^\circ C$
V_{UVREL}	UVLO Release Voltage	V_{IN} rising		2.05	2.3	V
V_{UVHYS}	UVLO Hysteresis	V_{IN} falling		0.15		V

All test items listed under *ELECTRICAL CHARACTERISTICS* are done under the pulse load condition ($T_j \approx T_a = 25^\circ C$) except Soft-Start Time and Turn-off Time and UVLO Hysteresis.

^{*2} Refer to *TYPICAL APPLICATION AND TECHNICAL NOTES*.

^{*3} Refer to *TIMING CHART*.

TIMING CHART

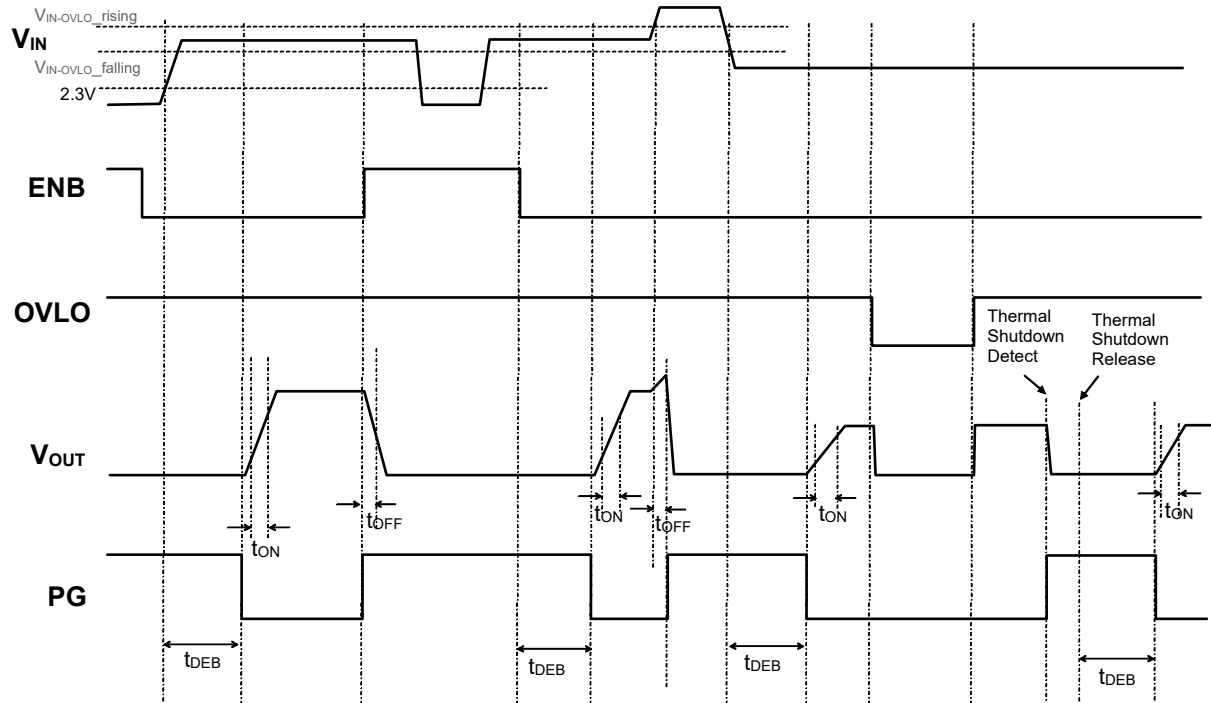

Figure 4. Timing Chart

TYPICAL APPLICATIONS AND TECHNICAL NOTES

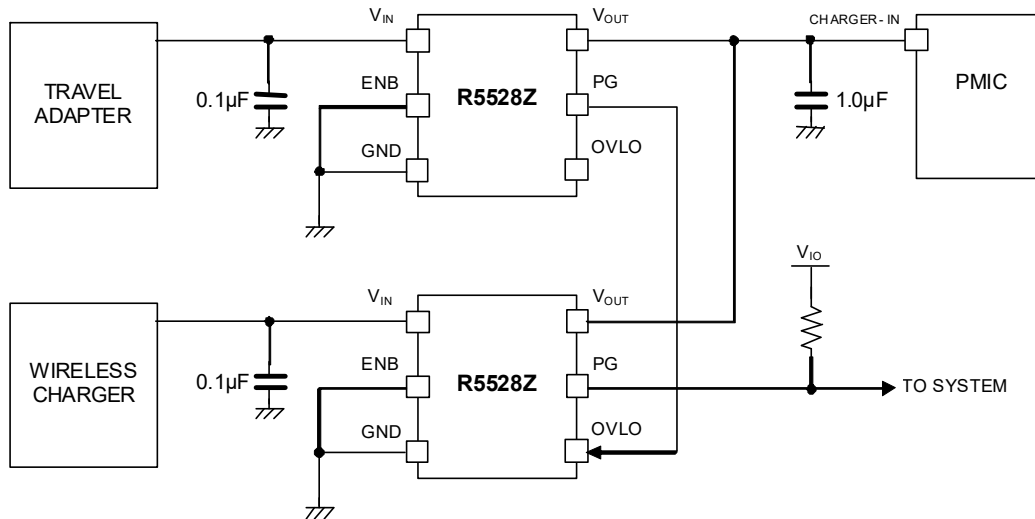

Figure 5. Typical Applications

Technical Notes

The R5528Z001A does not require any bypass capacitor between V_{IN} and GND. However, connecting a $0.1\mu\text{F}$ or more capacitor between V_{IN} and GND may improve the performance against the noise.

If there's any possibility of generating spike noise due to the parasitic element (inductance) of V_{IN} , connect an appropriate-sized capacitor between V_{IN} and GND.

TYPICAL CHARACTERISTIC

1) Input Shutdown Current VS. Input Voltage
R5528Z001A

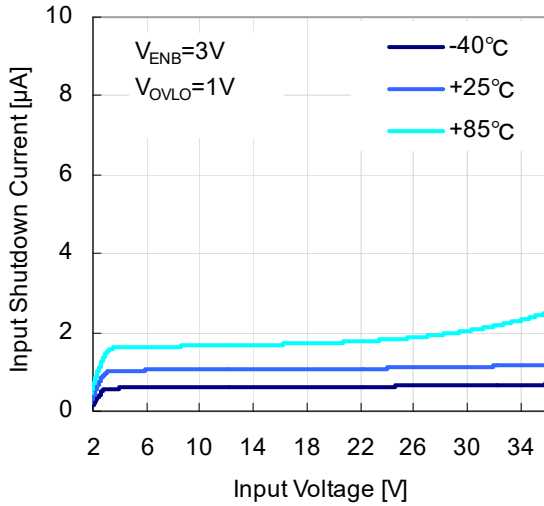

2) Input Supply Current VS. Input Voltage
R5528Z001A

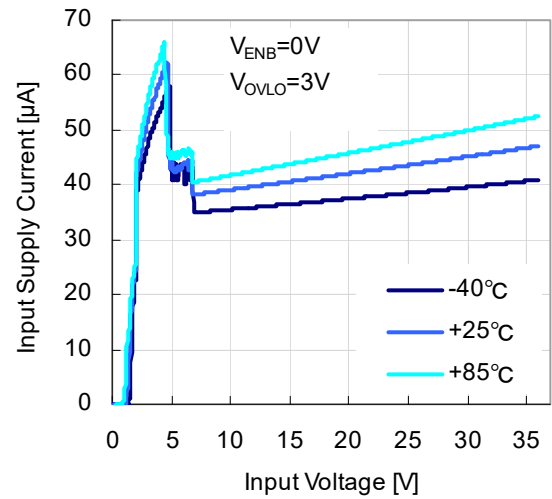

3) Input Disable Current VS. Input Voltage
R5528Z001A

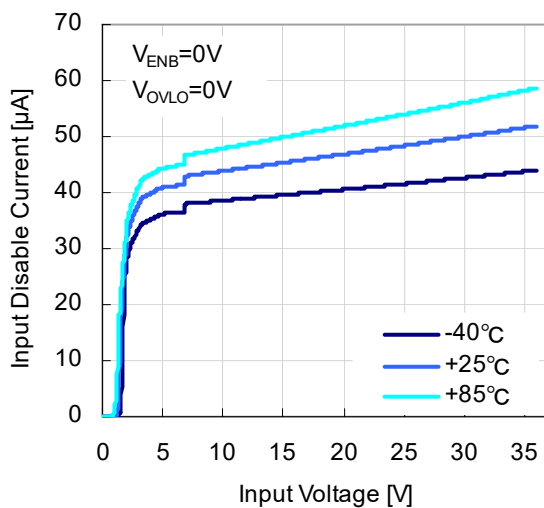

4) Input Supply Current VS. Temperature
R5528Z001A

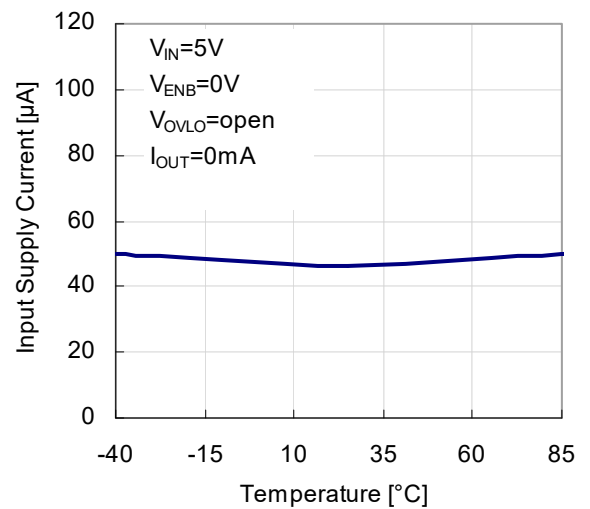

5) Output Leakage Current (6V) VS. Output Voltage
R5528Z001A

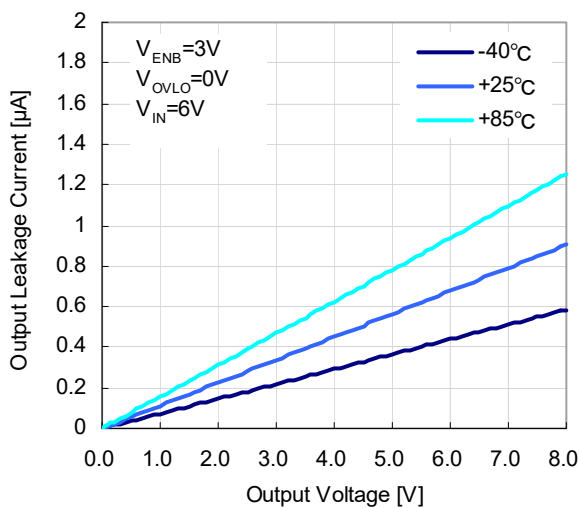

6) Output Leakage Current (0V) VS. Output Voltage
R5528Z001A

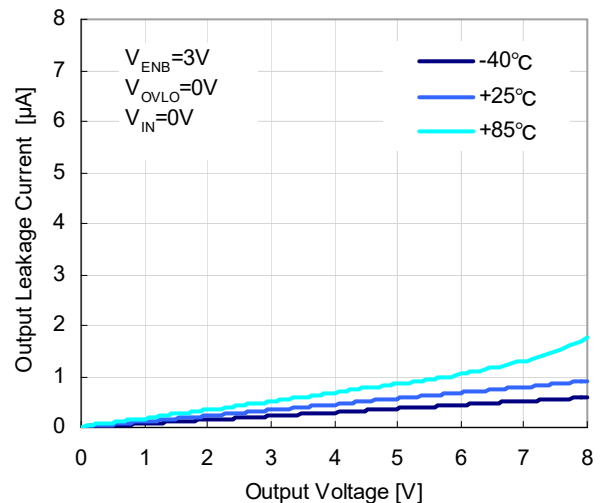

**7) Normalized On-Resistance VS. Temperature
R5528Z001A**

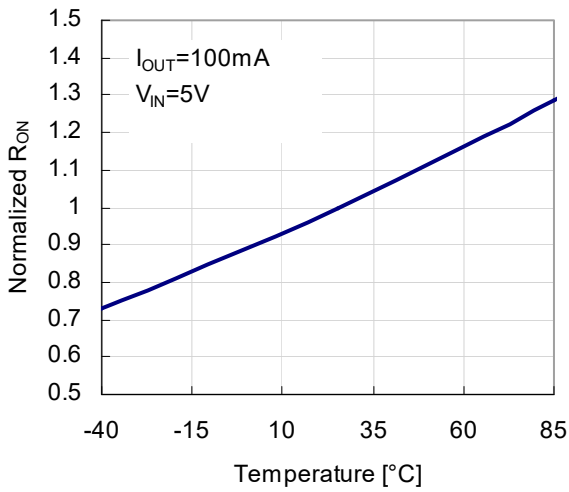

**8) Normalized Overvoltage Protection Threshold (IN rising) VS. Temperature
R5528Z001A**

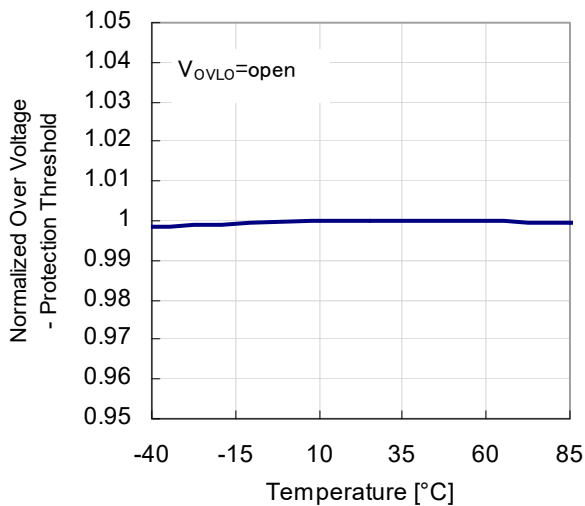

**9) Debounce Time VS. Temperature
R5528Z001A**

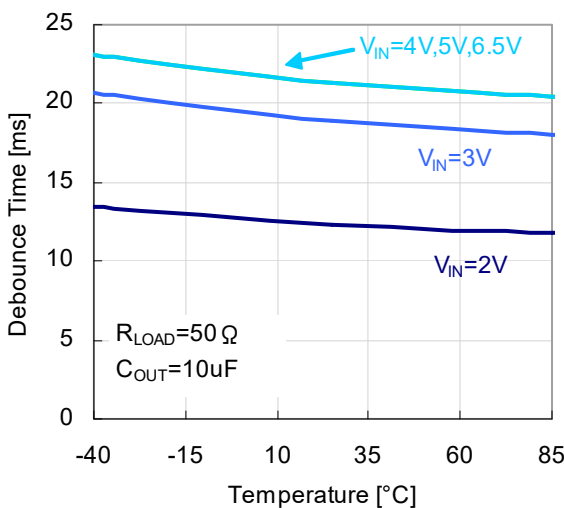

**10) Debounce Time VS. Input Voltage
R5528Z001A**

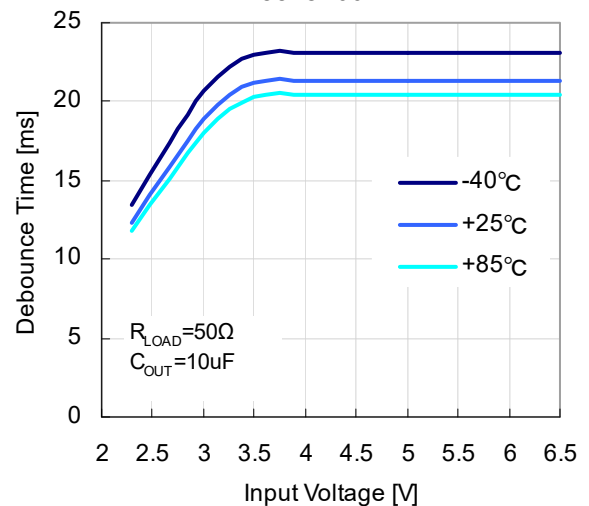

11) Trun-On Time VS. Temperature
R5528Z001A

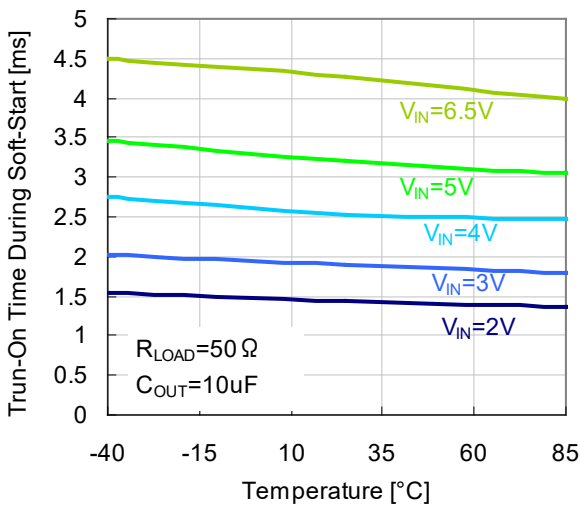

12) Power-Up Response (V_{IN} = 2.3V/ 3.0V/ 4.0V/ 5.0V)

R5528Z001A

R_{LOAD}=50Ω/C_{OUT}=10μF/PG=10KΩ to 5V/V_{ENB}=0V/Ta=25°C

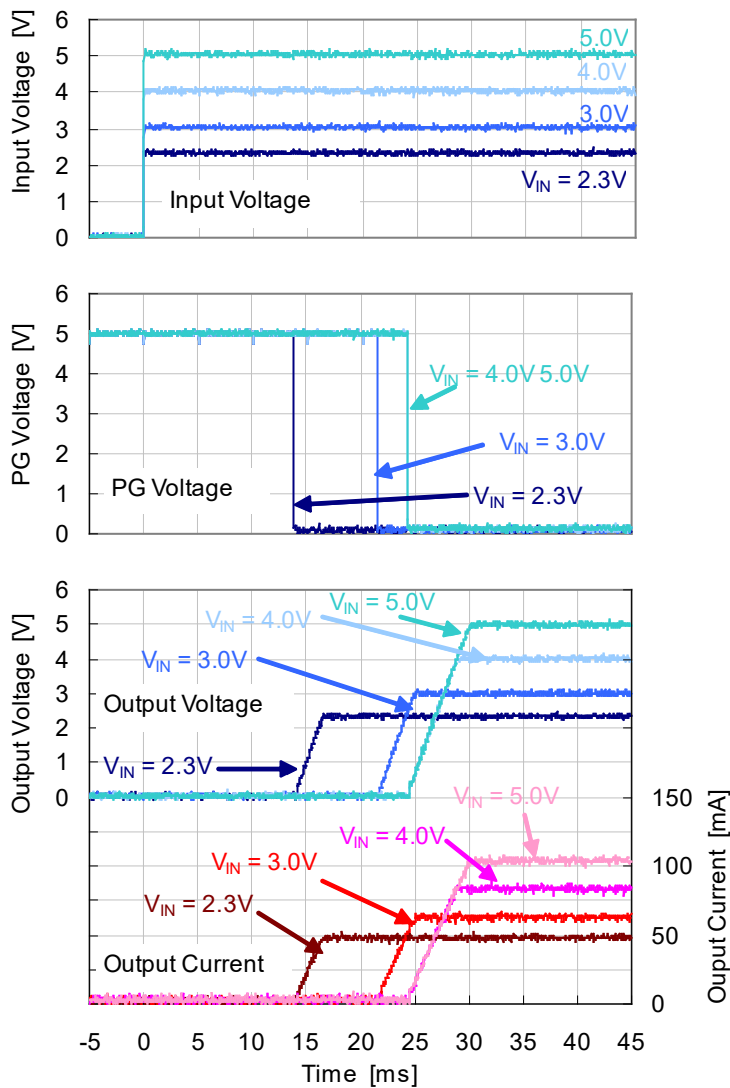

13) Power-Up Response ($R_{LOAD} = 10\Omega / 50\Omega / 500\Omega / 5K\Omega$)

R5528Z001A

$V_{IN}=5.0V / C_{OUT}=10\mu F / PG=10K\Omega \text{ to } 5V / V_{ENB}=0V / T_a=25^\circ C$

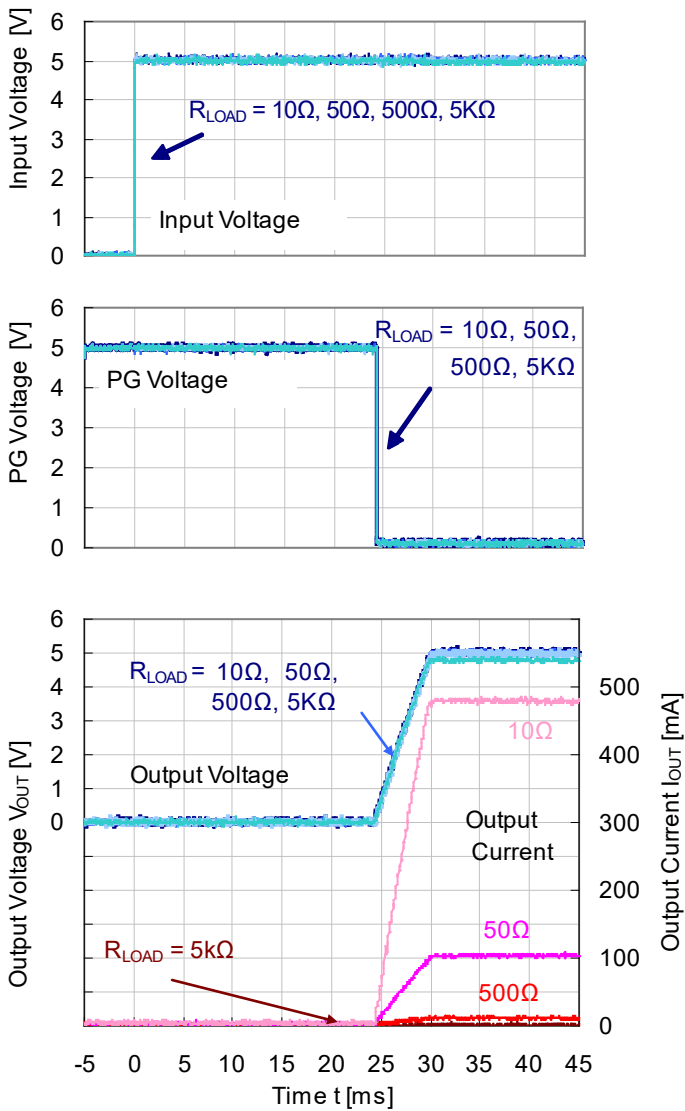

14) Power-Up Response ($C_{OUT} = 1\mu\text{F}/ 10\mu\text{F}/ 100\mu\text{F}/ 1000\mu\text{F}$)

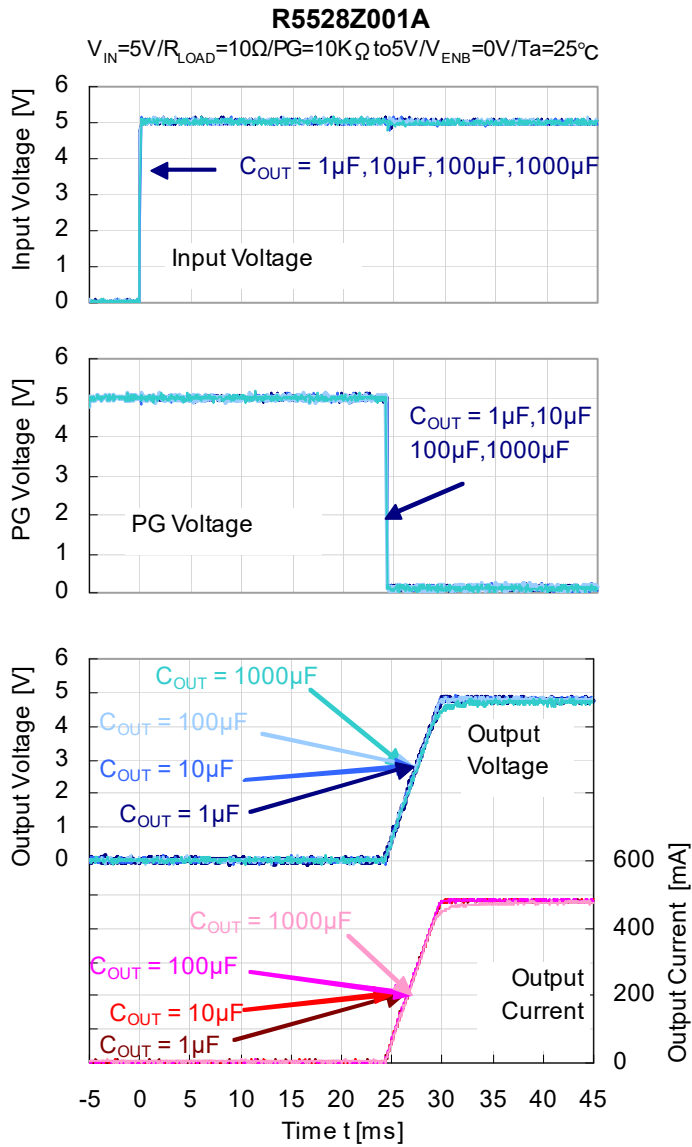

15) Overvoltage Fault Response

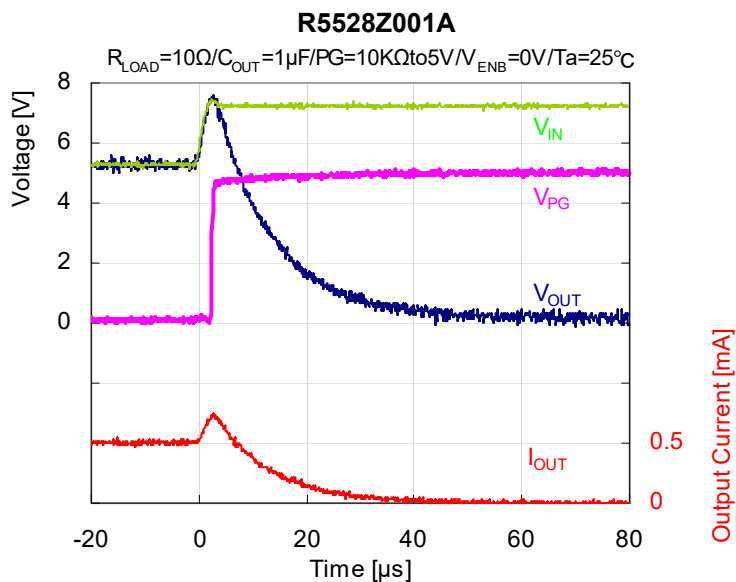

The power dissipation of the package is dependent on PCB material, layout, and environmental conditions. The following conditions are used in this measurement.

Measurement Conditions

High Wattage Land Pattern	
Environment	Mounting on Board (Wind Velocity = 0 m/s)
Board Material	Glass Cloth Epoxy Plastic (Four-layers)
Board Dimensions	76.2 mm × 114.3 mm × 1.6 mm
Copper Ratio	Outer Layers (First and Fourth Layers): Approx. 60% Inner Layers (Second and Third Layers): 100%

Measurement Result

(Ta = 25°C, Tjmax = 125°C)

High Wattage Land Pattern	
Power Dissipation	1190 mW
Thermal Resistance	$\theta_{ja} = (125 - 25^\circ\text{C}) / 1.19 \text{ W} = 84^\circ\text{C/W}$

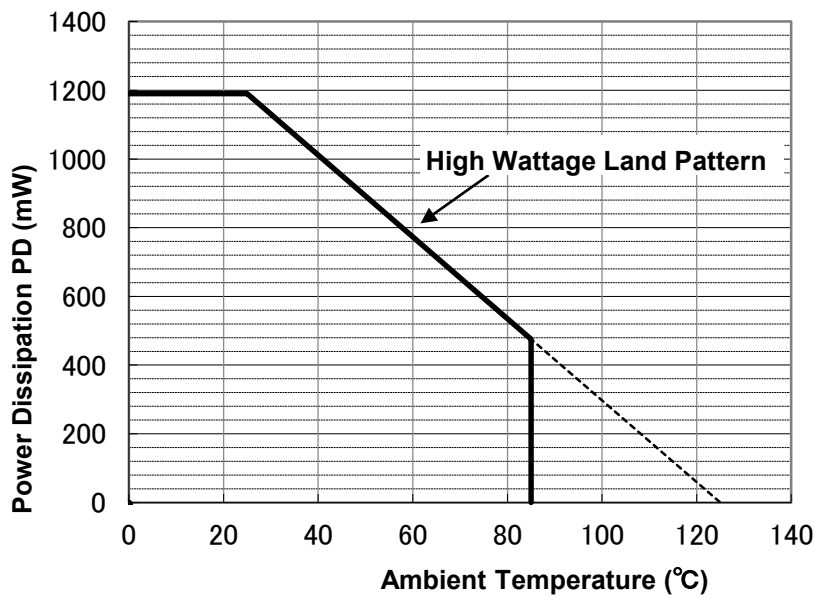

Power Dissipation vs. Ambient Temperature

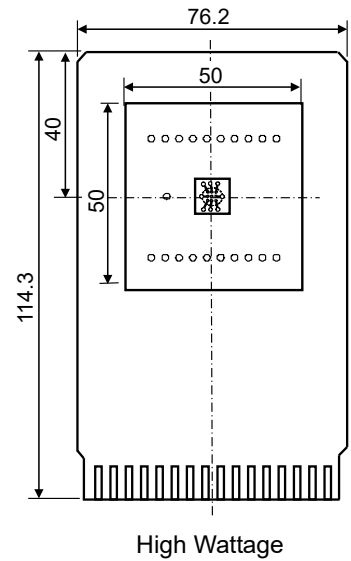

○ IC Mount Area (mm)
Measurement Board Pattern

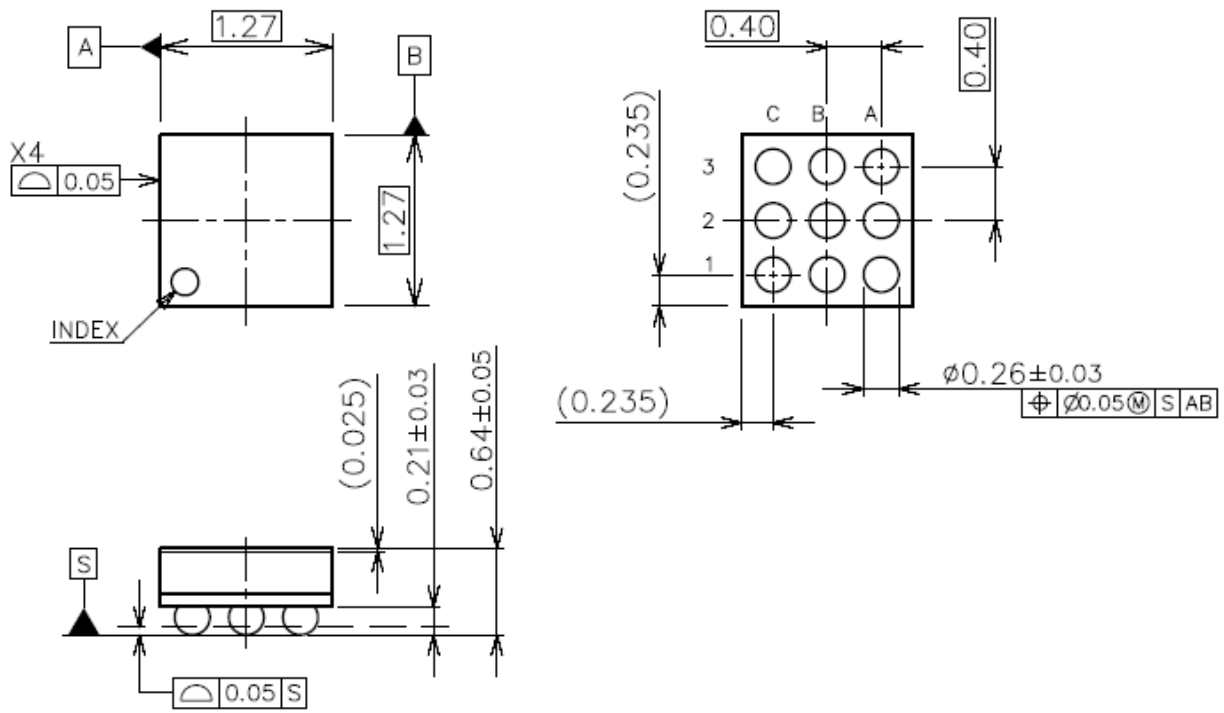

WLCSP-9-P1 Package Dimensions (Unit: mm)

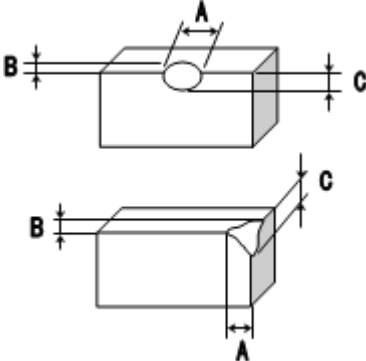
No.	Inspection Items	Inspection Criteria	Figure
1	Package chipping	$A \geq 0.2\text{mm}$ is rejected $B \geq 0.2\text{mm}$ is rejected $C \geq 0.2\text{mm}$ is rejected And, Package chipping to Si surface and to bump is rejected.	
2	Si surface chipping	$A \geq 0.2\text{mm}$ is rejected $B \geq 0.2\text{mm}$ is rejected $C \geq 0.2\text{mm}$ is rejected But, even if $A \geq 0.2\text{mm}$, $B \leq 0.1\text{mm}$ is acceptable.	
3	No bump	No bump is rejected.	
4	Marking miss	To reject incorrect marking, such as another product name marking or another lot No. marking.	
5	No marking	To reject no marking on the package.	
6	Reverse direction of marking	To reject reverse direction of marking character.	
7	Defective marking	To reject unreadable marking. (Microscope: X15/ White LED/ Viewed from vertical direction)	
8	Scratch	To reject unreadable marking character by scratch. (Microscope: X15/ White LED/ Viewed from vertical direction)	
9	Stain and Foreign material	To reject unreadable marking character by stain and foreign material. (Microscope: X15/ White LED/ Viewed from vertical direction)	



1. The products and the product specifications described in this document are subject to change or discontinuation of production without notice for reasons such as improvement. Therefore, before deciding to use the products, please refer to our sales representatives for the latest information thereon.
2. The materials in this document may not be copied or otherwise reproduced in whole or in part without prior written consent of our company.
3. Please be sure to take any necessary formalities under relevant laws or regulations before exporting or otherwise taking out of your country the products or the technical information described herein.
4. The technical information described in this document shows typical characteristics of and example application circuits for the products. The release of such information is not to be construed as a warranty of or a grant of license under our company's or any third party's intellectual property rights or any other rights.
5. The products listed in this document are intended and designed for use as general electronic components in standard applications (office equipment, telecommunication equipment, measuring instruments, consumer electronic products, amusement equipment etc.). Those customers intending to use a product in an application requiring extreme quality and reliability, for example, in a highly specific application where the failure or misoperation of the product could result in human injury or death (aircraft, spacevehicle, nuclear reactor control system, traffic control system, automotive and transportation equipment, combustion equipment, safety devices, life support system etc.) should first contact us.
6. We are making our continuous effort to improve the quality and reliability of our products, but semiconductor products are likely to fail with certain probability. In order to prevent any injury to persons or damages to property resulting from such failure, customers should be careful enough to incorporate safety measures in their design, such as redundancy feature, fire containment feature and fail-safe feature. We do not assume any liability or responsibility for any loss or damage arising from misuse or inappropriate use of the products.
7. Anti-radiation design is not implemented in the products described in this document.
8. The X-ray exposure can influence functions and characteristics of the products. Confirm the product functions and characteristics in the evaluation stage.
9. WLCSP products should be used in light shielded environments. The light exposure can influence functions and characteristics of the products under operation or storage.
10. There can be variation in the marking when different AOI (Automated Optical Inspection) equipment is used. In the case of recognizing the marking characteristic with AOI, please contact our sales or our distributor before attempting to use AOI.
11. Please contact our sales representatives should you have any questions or comments concerning the products or the technical information.



Nisshinbo Micro Devices Inc.

Official website

<https://www.nisshinbo-microdevices.co.jp/en/>

Purchase information

<https://www.nisshinbo-microdevices.co.jp/en/buy/>

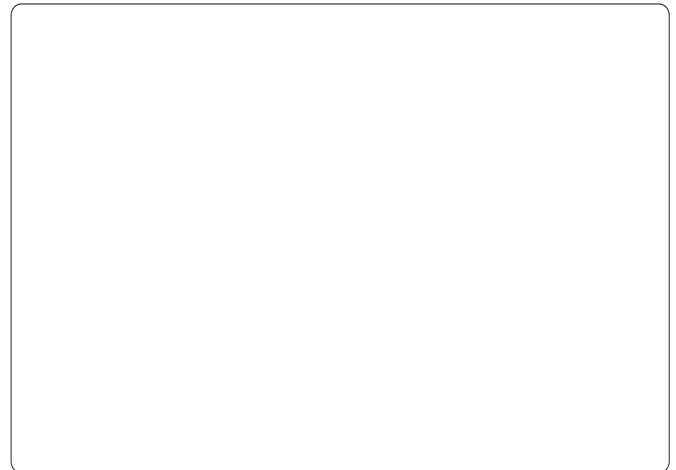

Mouser Electronics

Authorized Distributor

Click to View Pricing, Inventory, Delivery & Lifecycle Information:

[Nisshinbo Micro Devices:](#)

[R5528Z001A-E2-F](#)