

**Contactless Encoder**  
**Analog**  
**RI360P0-QR24M0-ELIU5X2-H1151**

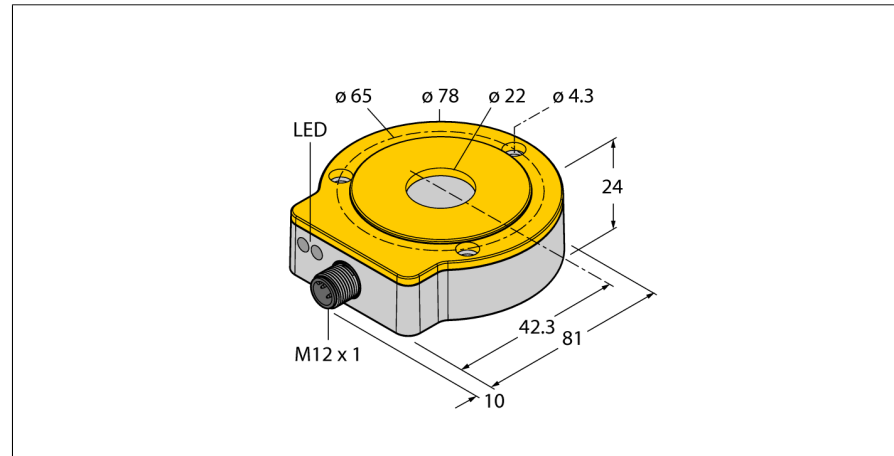

- Compact, rugged housing
- Many mounting possibilities
- Status displayed via LED
- Measuring range indicated via LED
- Immune to electromagnetic interference
- Measuring range programmable via Easy Teach
- Output signal programmable via Easy Teach
- Resolution, 16-bit
- 15...30 VDC
- 0...10 V and 4...20 mA
- Male M12 x 1, 5-pin

<b>Type designation</b>	RI360P0-QR24M0-ELIU5X2-H1151
Ident no.	1590908
<b>Measuring principle</b>	inductive
Max. Rotational Speed	12000 rpm Determined with standardized construction, with a steel shaft $\varnothing$ 20 mm, L = 50 mm and reducer $\varnothing$ 20 mm
Starting torque shaft load (radial / axial)	not applicable, because of contactless measuring principle
Resolution	16 bit
Measuring range	0...360°
Nominal distance	1.5 mm
Repeat accuracy	$\leq 0.01$ % of full scale
Linearity deviation	$\leq 0.05$ % f.s.
Temperature drift	$\leq \pm 0.004$ % / K
Ambient temperature	-25...+85 °C
<b>Operating voltage</b>	15...30 VDC
Residual ripple	$\leq 10$ % $U_{is}$
Isolation test voltage	$\leq 0.5$ kV
Short-circuit protection	yes
Wire breakage/Reverse polarity protection	yes/ yes (voltage supply)
Output function	5-pin, Analog output
Output type	absolute singleturn
Singleturn/Resolution	16 Bit
Voltage output	0...10V
Current output	4...20 mA
Diagnostic	Positioning element not within detection range: Output signal 22 mA or 11 V
Load resistance voltage output	$\geq 4.7$ k $\Omega$
Load resistance, current output	$\leq 0.4$ k $\Omega$
Sample rate	5000 Hz
Current consumption	< 50 mA
<b>Dimensions</b>	81 x 78 x 24 mm
Shaft Type	Hollow shaft
Housing material	Metal/Plastic, ZnAlCu1/PBT-GF30-V0
Electrical connection	Connectors, M12 x 1
Vibration resistance	55 Hz (1 mm)
Vibration resistance (EN 60068-2-6)	20 g; 10...3000 Hz; 50 cycles; 3 axes
Shock resistance (EN 60068-2-27)	100 g; 11 ms 1/2 sinus; each 3x; 3 axes
Continuous shock resistance (EN 60068-2-29)	40 g; 6 ms 1/2 sinus; each 4000 x; 3 axes
Protection class	IP68/IP69K
MTTF	138 years acc. to SN 29500 (Ed. 99) 40 °C
Packaging unit	1
<b>Power-on indication</b>	LED, Green
Measuring range display	LED, yellow, yellow flashing

**Wiring Diagram**

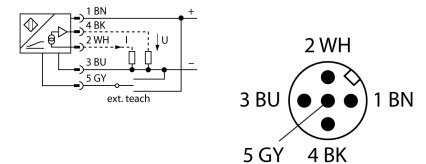

**Functional principle**

The measuring principle of inductive angle sensors is based on oscillation circuit coupling between the positioning element and the sensor, whereby an output signal is provided proportional to the angle of the positioning element. The rugged sensors are wear and maintenance-free, thanks to the contactless operating principle. They convince through their excellent repeatability, resolution and linearity within a broad temperature range. The innovative technology ensures a high immunity to electromagnetic DC and AC fields.

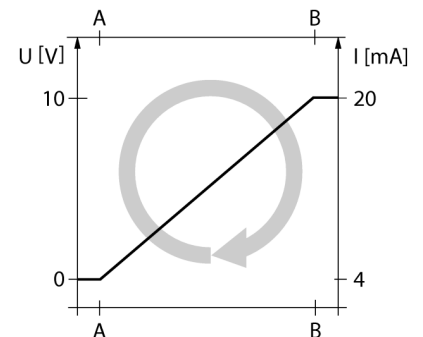

**Contactless Encoder  
Analog  
RI360P0-QR24M0-ELIU5X2-H1151**

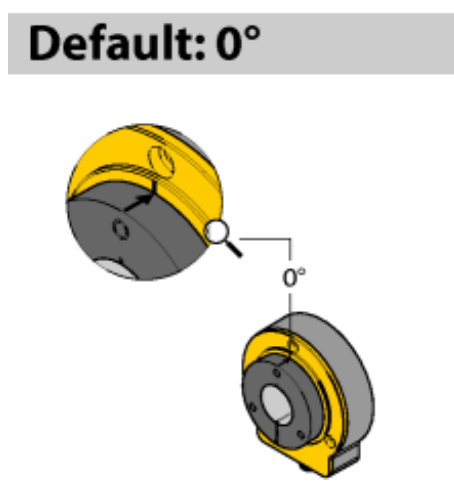
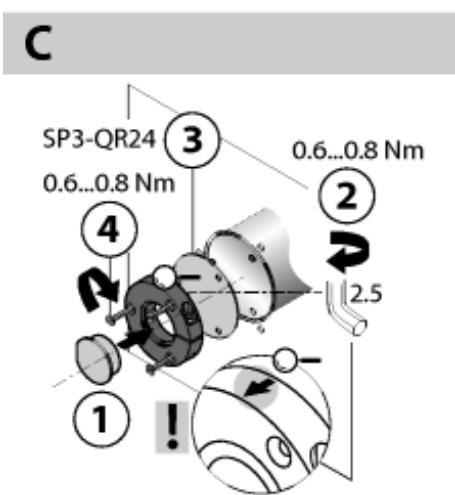
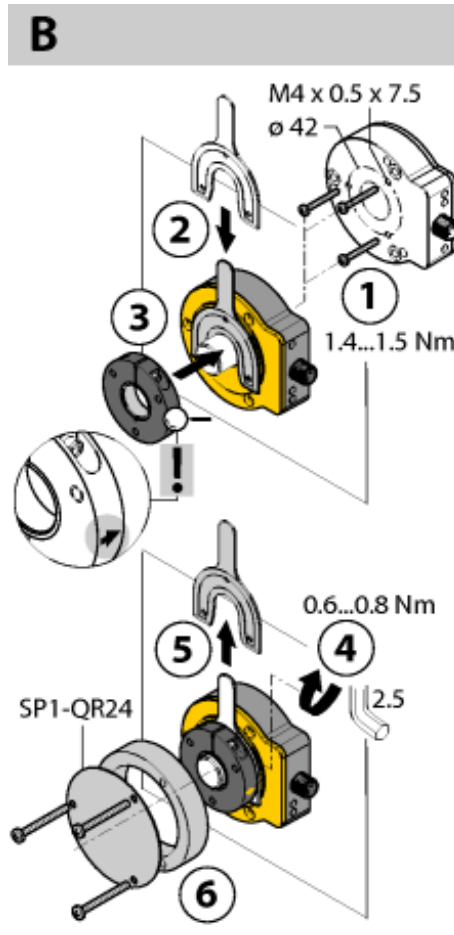
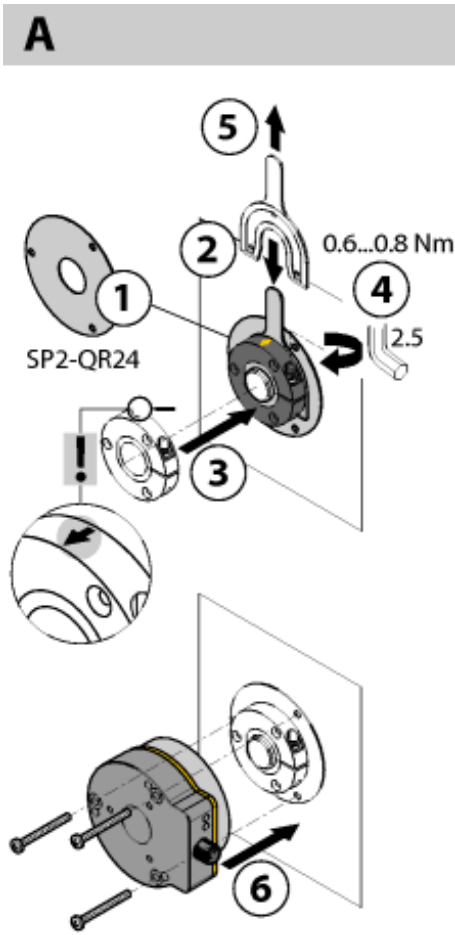

Extensive range of mounting accessories for easy adaptation to many different shaft diameters. Based on the functional principle of RLC coupling, the sensor operates absolutely wear-free and is immune to magnetized metal splinters and other interference fields. Wrong installation is hardly possible.

The adjacent figure shows the two separate units, sensor and positioning element.

**Mounting option A:**

First, interconnect positioning element and rotatable shaft. Then place the encoder above the rotating part in such a way that you get a tight and protected unit.

**Mounting option B:**

Push the encoder on the back site of the shaft and fasten it to the machine. Then clamp the positioning element to the shaft with the bracket.

**Mounting option C:**

If the positioning element is to be screwed on a rotating machine part, use the RA0-QR24 plug which is included in the delivery. Then tie up the bracket. Screw on the encoder via the three bores.

The separately arranged sensor and positioning element inhibit that compensating currents or damaging mechanical loads are transmitted via the shaft to the sensor. In addition, the encoder remains tight and highly protected during its entire lifespan.

The accessories enclosed in the delivery help to mount encoder and positioning element at an optimal distance from each other. LEDs indicate the switching status.

**Status display via LED**

**green steady:**

Optimal sensor supply

**yellow steady:**

Positioning element has reached the end of the measuring range. This is indicated by a lower signal quality.

**yellow flashing:**

Positioning element is outside the measuring range.

**off:**

Positioning element is in the measuring range.

**Contactless Encoder**  
**Analog**  
**RI360P0-QR24M0-ELIU5X2-H1151**

**Individual Parameterization (Teaching with Positioning Element)**

Bridge between teach input Pin 5 (GY)	Gnd Pin 3 (BU)	Ub Pin1 (BN)	LED
2 s	Start value	End value	Status LED flashes then turns steady after 2 s
10 s	CCW rotation, then return to last preset value	CW rotation, then return to last preset value	After 10 s status LED flashes fast for 2 s
15 s	-	Factory setting (360°, CW)	after 15 s power and status LED alternate

To avoid unintended teaching, keep pin 5 potential-free.

**Preset Parameterization (Teaching without Positioning Element)**

Bridge pin between teach input Pin 5 (GY)	Gnd Pin 3 (BU)	Ub Pin 1 (BN)	LED
2 s	Activate selection mode for output signal (for 10 s)	Activate preset mode (for 10 s)	Status LED steady, flashes after 2 s
10 s	CCW rotation direction	CW rotation direction	After 10 s status LED flashes fast for 2 s
15 s		Factory setting (360°, CW)	After 15 s power and status LED flash equally fast
<b>Output configuration</b>	<b>Gnd Pin 3 (BU)</b>		<b>Status LED</b>
I out: 4...20 mA	Press once		1 x flashing
I out: 0...20 mA	Press twice		2 x flashing
Uout: 0...10 V	Press three times		3 x flashing
Uout: 0...5 V	Press four times		4 x flashing
Uout: 0.5 V / 4.5 V	Press five times		5 x flashing
<b>Preset mode / Angular range</b>		<b>Ub Pin 1 (BN)</b>	<b>Status LED</b>
45°		Press once	1 x flashing
60°		Press twice	2 x flashing
90°		Press three times	3 x flashing
180°		Press four times	4 x flashing
270°		Press five times	5 x flashing

To avoid unintended teaching, keep pin 5 potential-free.

**Contactless Encoder**  
**Analog**  
**RI360P0-QR24M0-ELIU5X2-H1151**

**Accessories**

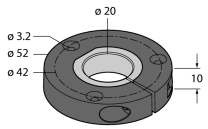
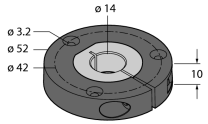
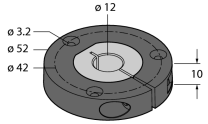
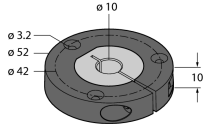
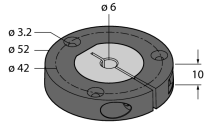
Type code	Ident no.	Description	
P1-RI-QR24	1590921	Positioning element, for Ø 20 mm shafts	
P2-RI-QR24	1590922	Positioning element, for Ø 14 mm shafts	
P3-RI-QR24	1590923	Positioning element, for Ø 12 mm shafts	
P4-RI-QR24	1590924	Positioning element, for Ø 10 mm shafts	
P5-RI-QR24	1590925	Positioning element, for Ø 6 mm shafts	

**Contactless Encoder**  
**Analog**  
**RI360P0-QR24M0-ELIU5X2-H1151**

**Accessories**

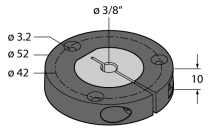
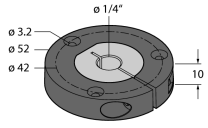
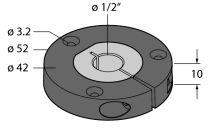
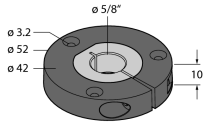
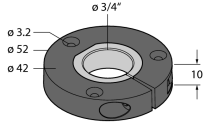
Type code	Ident no.	Description	
P6-RI-QR24	1590926	Positioning element, for Ø 3/8" shafts	
P7-RI-QR24	1590927	Positioning element, for Ø 1/4" shafts	
P9-RI-QR24	1593012	Positioning element for installation on Ø 1/2" shafts	
P10-RI-QR24	1593013	Positioning element for installation on Ø 5/8" shafts	
P11-RI-QR24	1593014	Positioning element for installation on Ø 3/4" shafts	

**Contactless Encoder**  
**Analog**  
**RI360P0-QR24M0-ELIU5X2-H1151**

**Accessories**

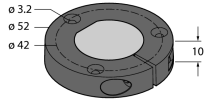
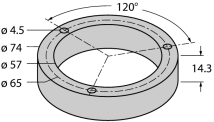
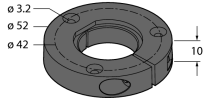
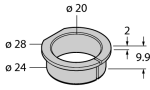
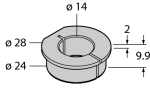
Type code	Ident no.	Description	
P8-RI-QR24	1590916	Positioning element with blanking plug for large shafts	
M1-QR24	1590920	Aluminium protecting ring, for inductive encoders RI-QR24	
PE1-QR24	1590937	Positioning element without adapter sleeve	
RA1-QR24	1590928	Adapter sleeve, for Ø 20 mm shafts	
RA2-QR24	1590929	Adapter sleeve, for Ø 14 mm shafts	



**Contactless Encoder**  
**Analog**  
**RI360P0-QR24M0-ELIU5X2-H1151**

**Accessories**

Type code	Ident no.	Description	
RA3-QR24	1590930	Adapter sleeve, for Ø 12 mm shafts	
RA4-QR24	1590931	Adapter sleeve, for Ø 10 mm shafts	
RA5-QR24	1590932	Adapter sleeve, for Ø 6 mm shafts	
RA6-QR24	1590933	Adapter sleeve, for Ø 3/8" shafts	
RA7-QR24	1590934	Adapter sleeve, for Ø 1/4" shafts	

**Contactless Encoder**  
**Analog**  
**RI360P0-QR24M0-ELIU5X2-H1151**

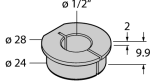
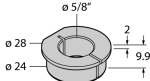
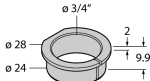
**Accessories**

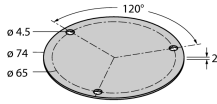
Type code	Ident no.	Description	
RA9-QR24	1590960	Adapter sleeve, for Ø 1/2" shafts	
RA10-QR24	1590961	Adapter sleeve, for Ø 5/8" shafts	
RA11-QR24	1590962	Adapter sleeve, for Ø 3/4" shafts	
RA8-QR24	1590959	Plug for Cu mounting option (reducing sleeves)	
SP1-QR24	1590938	Shield Ø 74 mm, aluminium	



**Contactless Encoder**  
**Analog**  
**RI360P0-QR24M0-ELIU5X2-H1151**

**Accessories**

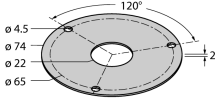
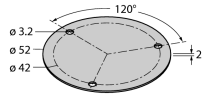
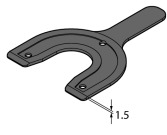
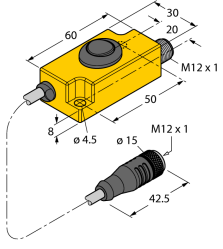
Type code	Ident no.	Description	
SP2-QR24	1590939	Shield Ø 74 mm, aluminium, with borehole for shaft feedthrough	
SP3-QR24	1590958	Shield Ø 52 mm, aluminium	
MT-QR24	1590935	Mounting aid for optimal alignment of positioning element	
TX1-Q20L60	6967114	Teach adapter for inductive encoders, linear position, angle, ultrasonic and capacitive sensors	

**Wiring accessories**

Type code	Ident no.	Description	
RKS4.5T-2/TXL	6626373	Connection cable, female M12, straight, 5-pin shielded, cable length: 2 m, sheath material: PUR, black; cULus approval; other cable lengths and qualities available, see <a href="http://www.turck.com">www.turck.com</a>	