

Half-Bridge Gate Driver

FAN7380

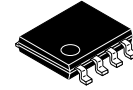

SOIC8
(8-SOP)
CASE 751EG

Description

The FAN7380 is a monolithic half-bridge gate-drive IC for MOSFETs and IGBTs that operate up to +600 V. onsemi's high-voltage process and common-mode noise cancelling technique provide stable operation of high-side driver under high-dv/dt noise circumstances. An advanced level-shift circuit allows high-side gate driver operation up to $V_S = -9.8$ V (typical) for $V_{BS} = 15$ V. The input logic level is compatible with standard TTL-series logic gates. The internal shoot-through protection circuit provides 100 ns dead-time to prevent output switching devices from both conducting during transition periods. UVLO circuits for both channels prevent malfunction when V_{CC} and V_{BS} are lower than the specified threshold voltage. Output drivers typically source / sink at 90 mA / 180 mA, respectively, which is suitable for fluorescent / compact fluorescent lamp ballast applications and systems requiring low di/dt noise.

Features

- Floating Channel Designed for Bootstrapping Operation to +600 V
- Typically 90 mA / 180 mA Sourcing/Sinking Current Driving Capability for Both Channels
- Common-Mode dv/dt Noise Cancelling Circuit
- Extended Allowable Negative V_S Swing to -9.8 V for Signal Propagation at $V_{CC} = V_{BS} = 15$ V
- V_{CC} & V_{BS} Supply Range from 10 V to 20 V
- UVLO Functions for Both Channels
- TTL-Compatible Input Logic Threshold Levels
- Matched Propagation Delay Below 50 ns
- Built-in 100 ns Dead-Time Control Function
- Output In-Phase with Input Signal
- This is a Pb-Free Device

Typical Applications

- Fluorescent Lamp Ballast
- Compact Fluorescent Lamp Ballast

Related Resources

- <https://www.onsemi.com/pub/collateral/an-6076.pdf>
- <https://www.onsemi.com/pub/collateral/an-9052.pdf>
- <https://www.onsemi.com/pub/collateral/an-8102.pdf>

MARKING DIAGRAM

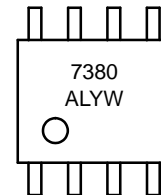

7380	= Device Code
A	= Assembly Site
L	= Wafer Lot Number
YW	= Assembly Start Week

ORDERING INFORMATION

See detailed ordering and shipping information on page 11 of this data sheet.

FAN7380

TYPICAL APPLICATION CIRCUIT

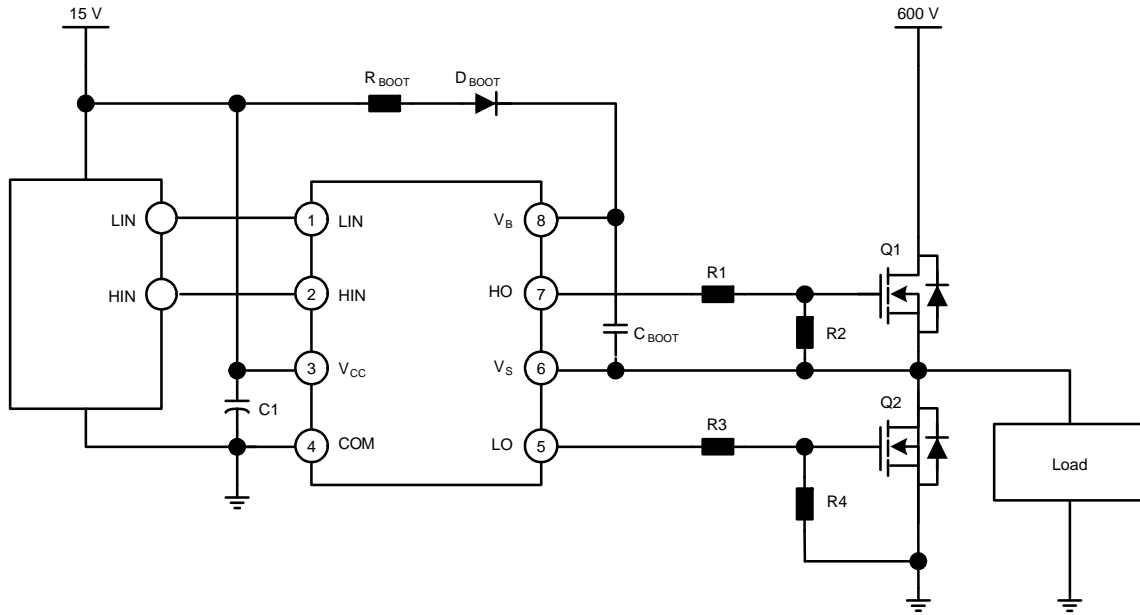

Figure 1. Application Circuit for Fluorescent Lamp Ballast

INTERNAL BLOCK DIAGRAM

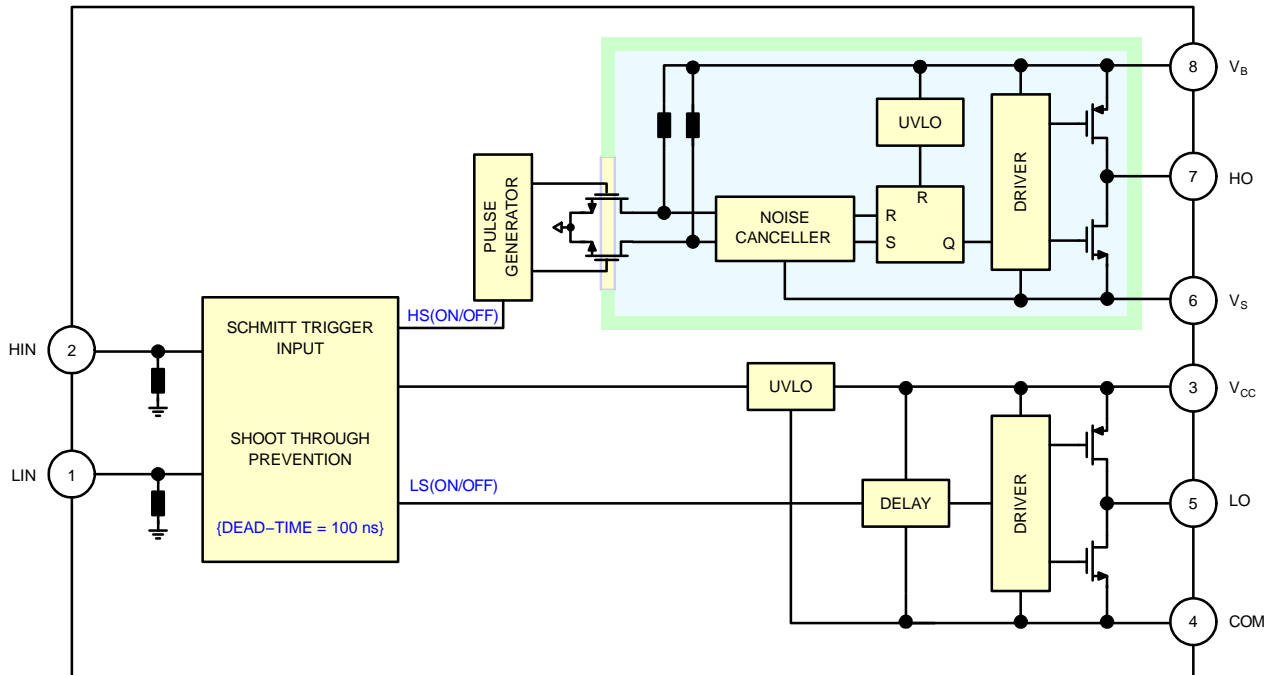

Figure 2. Functional Block Diagram

FAN7380

PIN CONFIGURATION

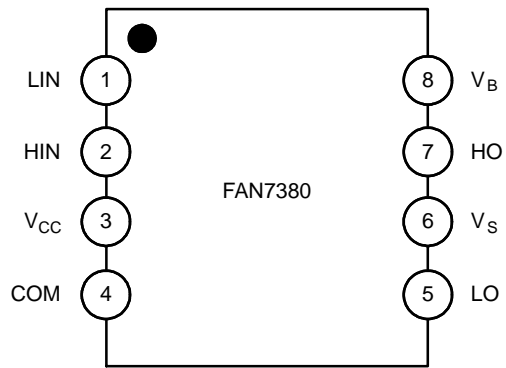

Figure 3. Pin Configuration (Top View)

PIN DEFINITIONS

Pin No.	Name	I/O	Description
1	LIN	I	Logic Input for Low-Side Gate Driver Output
2	HIN	I	Logic Input for High-Side Gate Driver Output
3	V _{CC}	I	Low-Side Supply Voltage
4	COM		Logic Ground and Low-Side Driver Return
5	LO	O	Low-Side Driver Output
6	V _S	I	High-Voltage Floating Supply Return
7	HO	O	High-Side Driver Output
8	V _B	I	High-Side Floating Supply

FAN7380

ABSOLUTE MAXIMUM RATINGS (T_A = 25°C, unless otherwise specified.)

Symbol	Parameter	Min	Max	Unit
V _S	High-side Offset Voltage	V _B - 25	V _B + 0.3	V
V _B	High-side Floating Supply Voltage	-0.3	625.0	
V _{HO}	High-side Floating Output Voltage HO	V _S - 0.3	V _B + 0.3	
V _{CC}	Low-side and Logic-fixed Supply Voltage	-0.3	25.0	
V _{LO}	Low-side Output Voltage LO	-0.3	V _{CC} + 0.3	
V _{IN}	Logic Input Voltage (HIN, LIN)	-0.3	V _{CC} + 0.3	
COM	Logic Ground	V _{CC} - 25	V _{CC} + 0.3	
dV _S /dt	Allowable Offset Voltage Slew Rate	-	50	V/ns
P _D (Note 1, 2, 3)	Power Dissipation	-	0.625	W
θ _{JA}	Thermal Resistance, Junction-to-ambient	-	200	°C/W
T _J	Junction Temperature	-	150	°C
T _S	Storage Temperature	-50	150	°C

Stresses exceeding those listed in the Maximum Ratings table may damage the device. If any of these limits are exceeded, device functionality should not be assumed, damage may occur and reliability may be affected.

1. Mounted on 76.2 x 114.3 x 1.6 mm PCB (FR-4 glass epoxy material).
2. Refer to the following standards:
 JESD51-2: Integral circuits thermal test method environmental conditions – natural convection
 JESD51-3: Low effective thermal conductivity test board for leaded surface mount packages
3. Do not exceed P_D under any circumstances.

RECOMMENDED OPERATING RATINGS

Symbol	Parameter	Min	Max	Unit
V _B	High-side Floating Supply Voltage	V _S + 10	V _S + 20	V
V _S	High-side Floating Supply Offset Voltage	6 - V _{CC}	600	
V _{HO}	High-side (HO) Output Voltage	V _S	V _B	
V _{LO}	Low-side (LO) Output Voltage	COM	V _{CC}	
V _{IN}	Logic Input Voltage (HIN, LIN)	COM	V _{CC}	
V _{CC}	Low-side Supply Voltage	10	20	
T _A	Ambient Temperature	-40	125	°C

Functional operation above the stresses listed in the Recommended Operating Ranges is not implied. Extended exposure to stresses beyond the Recommended Operating Ranges limits may affect device reliability.

FAN7380

STATIC ELECTRICAL CHARACTERISTICS (V_{BIAS} (V_{CC} , V_{BS}) = 15.0 V, T_A = 25°C, unless otherwise specified. The V_{IN} and I_{IN} parameters are referenced to COM. The V_O and I_O parameters are referenced to V_S and COM and are applicable to the respective outputs HO and LO.)

Symbol	Parameter	Test Condition	Min	Typ	Max	Unit
V_{CCUV+} V_{BSUV+}	V_{CC} & V_{BS} Supply Under-voltage Positive Going Threshold		8.2	9.2	10.0	V
V_{CCUV-} V_{BSUV-}	V_{CC} & V_{BS} Supply Under-voltage Negative Going Threshold		7.6	8.7	9.6	
V_{CCUVH} V_{BSUVH}	V_{CC} Supply Under-voltage Lockout Hysteresis		–	0.5	–	
I_{LK}	Offset Supply Leakage Current	$V_B = V_S = 600$ V	–	–	50	μ A
I_{QBS}	Quiescent V_{BS} Supply Current	$V_{IN} = 0$ V or 5 V	–	44	100	
I_{QCC}	Quiescent V_{CC} Supply Current	$V_{IN} = 0$ V or 5 V	–	70	180	
I_{PBS}	Operating V_{BS} Supply Current	$f_{IN} = 20$ kHz, rms value	–	–	600	μ A
I_{PCC}	Operating V_{CC} Supply Current	$f_{IN} = 20$ kHz, rms value	–	–	610	
V_{IH}	Logic “1” Input Voltage		2.5	–	–	V
V_{IL}	Logic “0” Input Voltage		–	–	0.8	
V_{OH}	High-level Output Voltage, $V_{BIAS}-V_O$	$I_O = 20$ mA	–	–	2.8	V
V_{OL}	Low-level Output Voltage, V_O		–	–	1.2	
I_{IN+}	Logic “1” Input Bias Current	$V_{IN} = 5$ V	–	5	40	μ A
I_{IN-}	Logic “0” Input Bias Current	$V_{IN} = 0$ V	–	1.0	2.0	
I_{O+}	Output HIGH Short-circuit Pulse Current	$V_O = 0$ V, $V_{IN} = 5$ V with $PW \leq 10$ μ s	60	90	–	mA
I_{O-}	Output LOW Short-circuit Pulsed Current	$V_O = 15$ V, $V_{IN} = 0$ V with $PW \leq 10$ μ s	130	180	–	
V_S	Allowable Negative V_S Pin Voltage for HIN Signal Propagation to HO		–	–9.8	–7.0	V

Product parametric performance is indicated in the Electrical Characteristics for the listed test conditions, unless otherwise noted. Product performance may not be indicated by the Electrical Characteristics if operated under different conditions.

DYNAMIC ELECTRICAL CHARACTERISTICS (V_{BIAS} (V_{CC} , V_{BS}) = 15.0 V, V_S = COM, C_L = 1000 pF and T_A = 25°C, unless otherwise specified.)

Symbol	Parameter	Test Condition	Min	Typ	Max	Unit
t_{on}	Turn-on Propagation Delay	$V_S = 0$ V	70	135	200	ns
t_{off}	Turn-off Propagation Delay	$V_S = 0$ V or 600 V (Note 4)	60	130	190	
t_r	Turn-on Rise Time		160	230	290	
t_f	Turn-off Fall Time		20	90	160	
DT	Dead Time		80	120	190	
MT	Delay Matching, HS & LS Turn-on/off		–	–	50	

Product parametric performance is indicated in the Electrical Characteristics for the listed test conditions, unless otherwise noted. Product performance may not be indicated by the Electrical Characteristics if operated under different conditions.

4. This parameter guaranteed by design.

TYPICAL PERFORMANCE CHARACTERISTICS

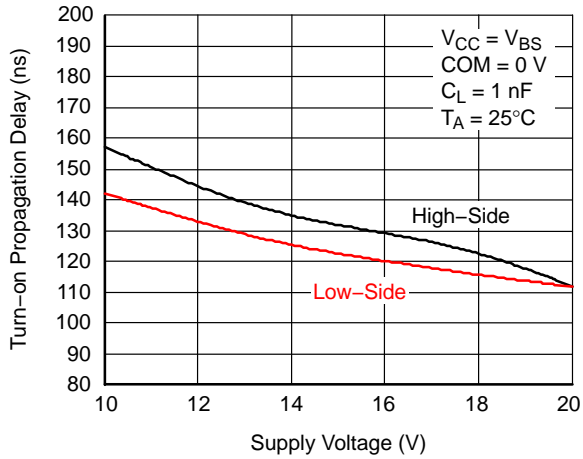

Figure 4. Turn-On Propagation Delay vs. Supply Voltage

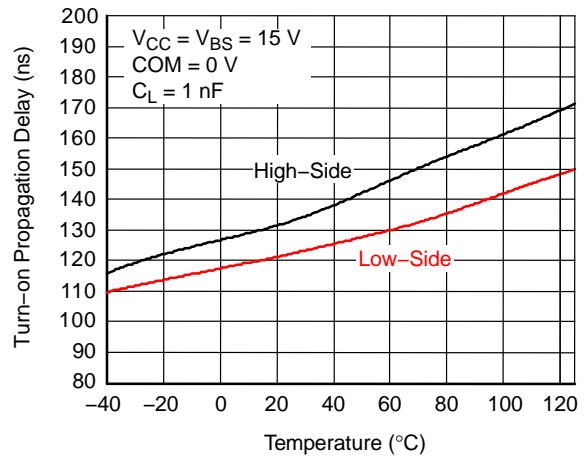

Figure 5. Turn-On Propagation Delay vs. Temperature

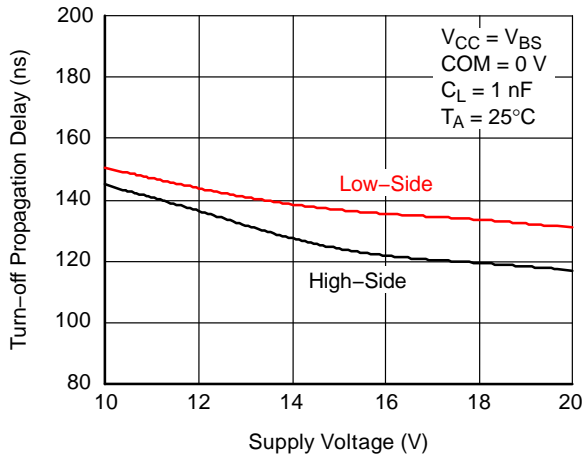

Figure 6. Turn-Off Propagation Delay vs. Supply Voltage

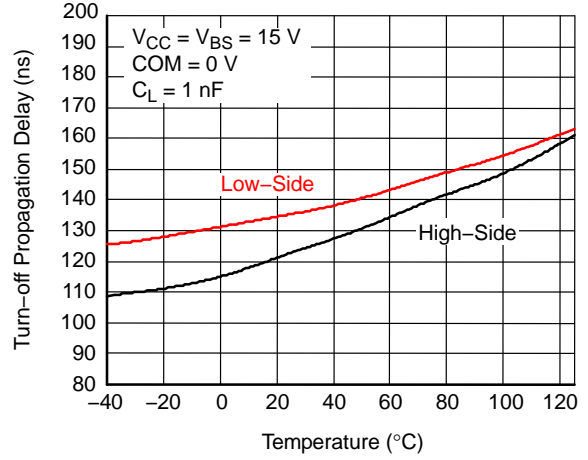

Figure 7. Turn-Off Propagation Delay vs. Temperature

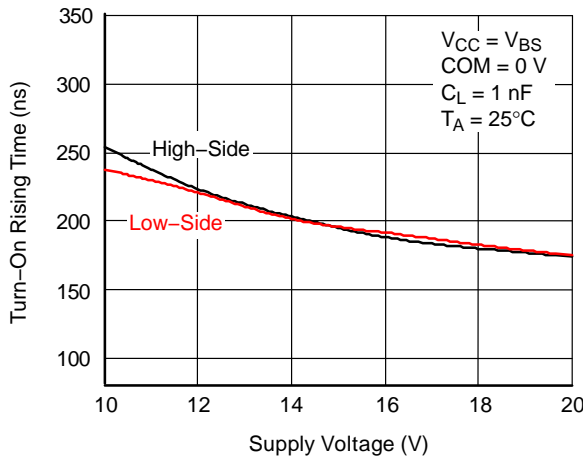

Figure 8. Turn-On Rising Time vs. Supply Voltage

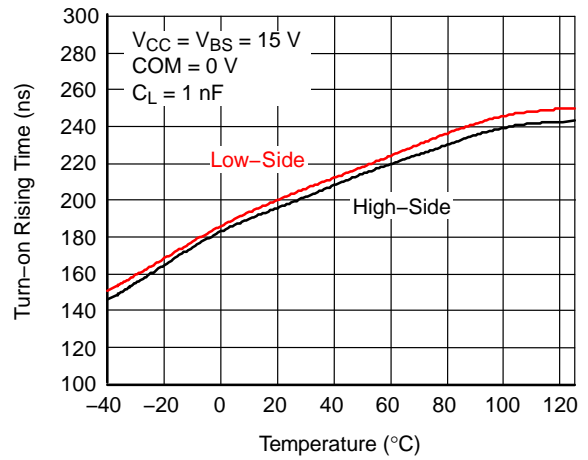

Figure 9. Turn-On Rising Time vs. Temperature

TYPICAL PERFORMANCE CHARACTERISTICS (Continued)

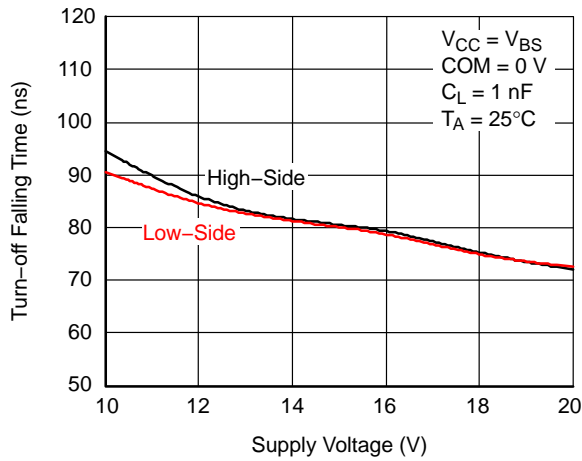

Figure 10. Turn-Off Falling Time vs. Supply Voltage

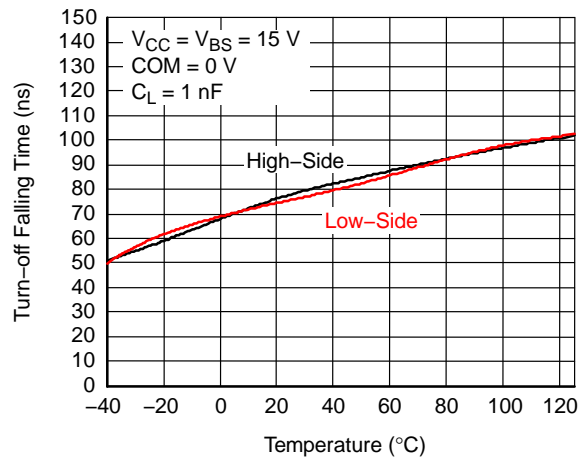

Figure 11. Turn-Off Falling Time vs. Temperature

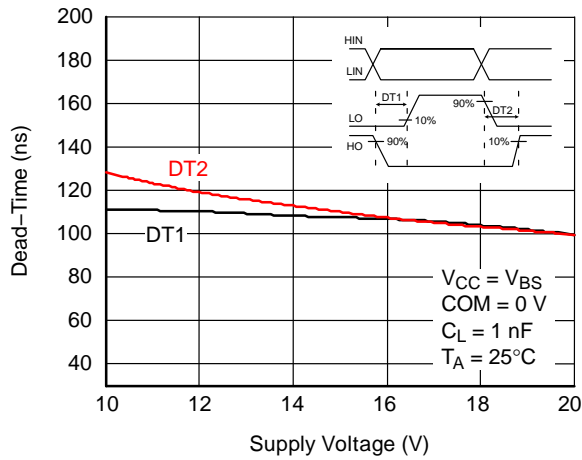

Figure 12. Dead-Time vs. Supply Voltage

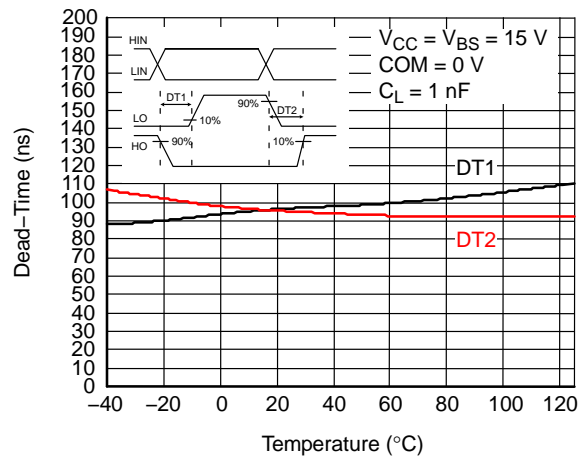

Figure 13. Dead-Time vs. Temperature

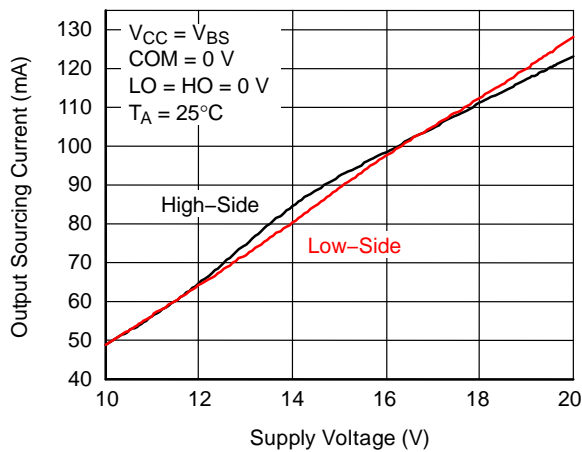

Figure 14. Output Sourcing Current vs. Supply Voltage

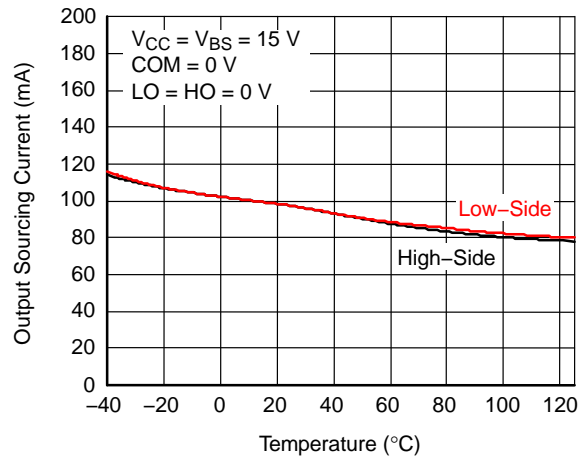

Figure 15. Output Sourcing Current vs. Temperature

TYPICAL PERFORMANCE CHARACTERISTICS (Continued)

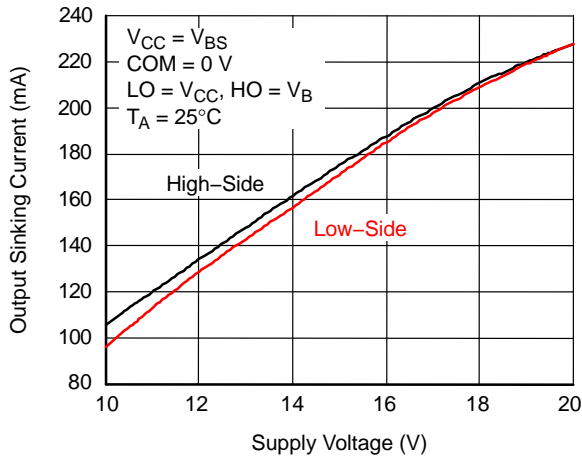

Figure 16. Output Sinking Current vs. Supply Voltage

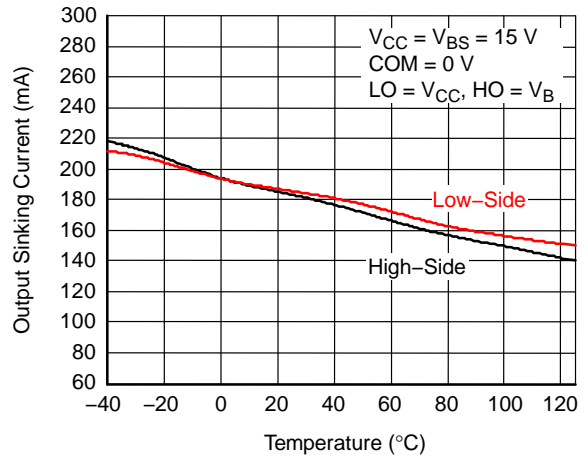

Figure 17. Output Sinking Current vs. Temperature

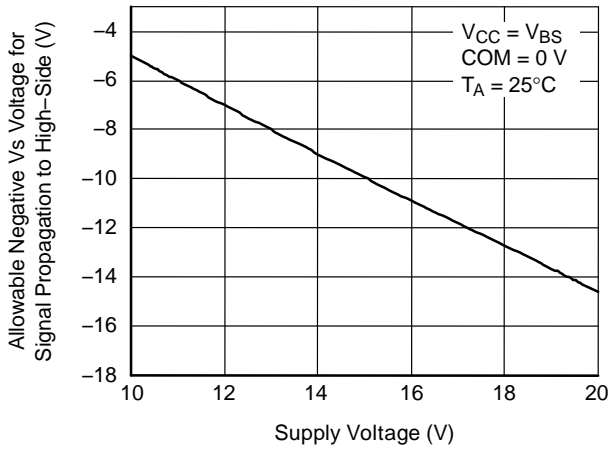

Figure 18. Allowable Negative Vs Voltage for Signal Propagation to High-Side vs. Supply Voltage

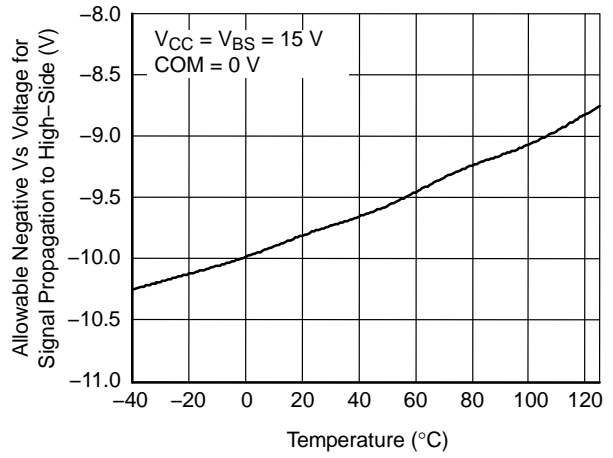

Figure 19. Allowable Negative Vs Voltage for Signal Propagation to High-Side vs. Temperature

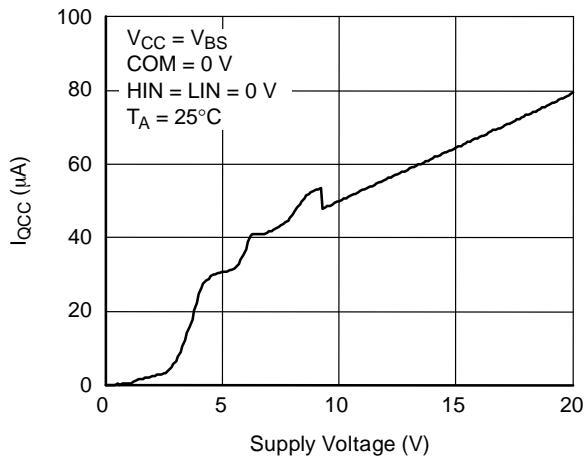

Figure 20. I_{QCC} vs. Supply Voltage

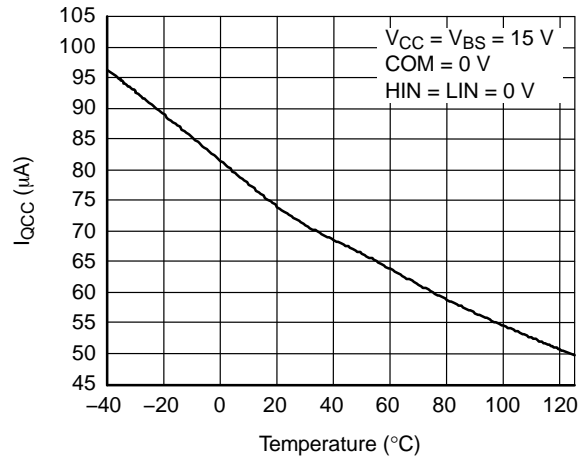

Figure 21. I_{QCC} vs. Temperature

TYPICAL PERFORMANCE CHARACTERISTICS (Continued)

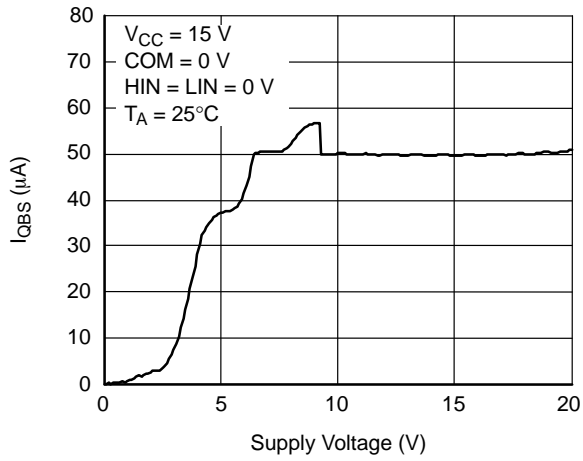

Figure 22. I_{QBS} vs. Supply Voltage

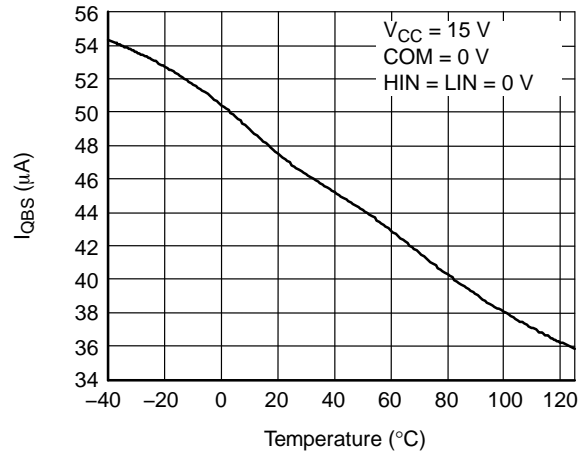

Figure 23. I_{QBS} vs. Temperature

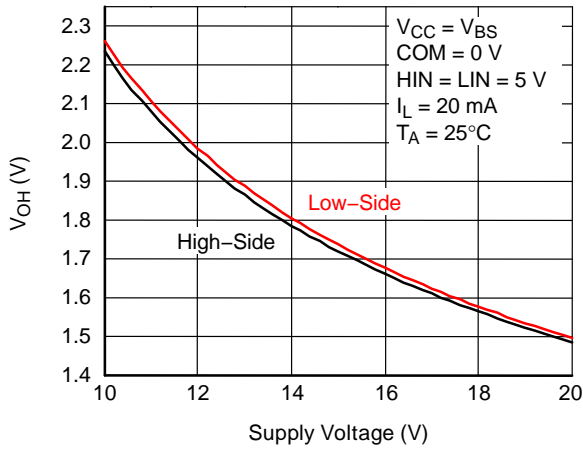

Figure 24. High-Level Output Voltage vs. Supply Voltage

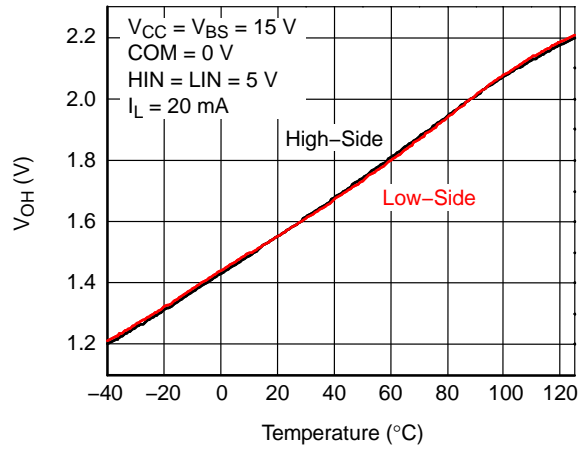

Figure 25. High-Level Output Voltage vs. Temperature

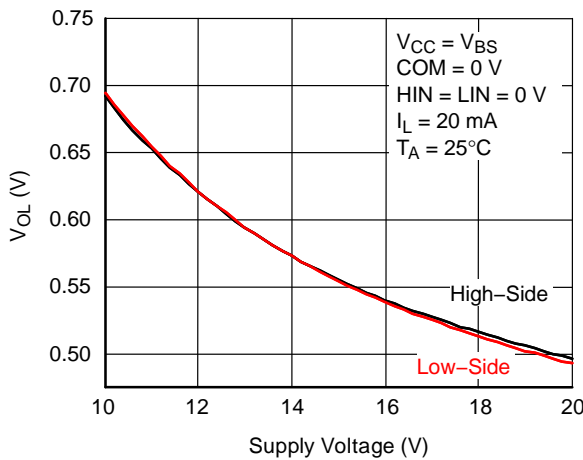

Figure 26. Low-Level Output Voltage vs. Supply Voltage

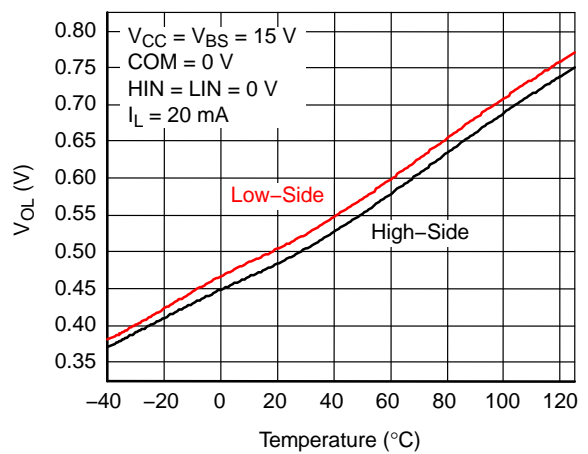

Figure 27. Low-Level Output Voltage vs. Temperature

TYPICAL PERFORMANCE CHARACTERISTICS (Continued)

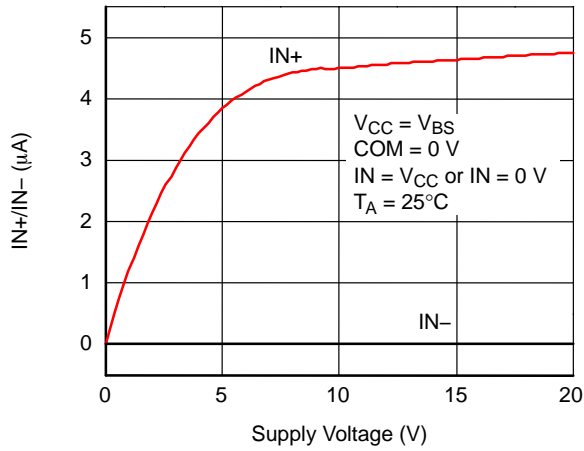

Figure 28. Input Bias Current vs. Supply Voltage

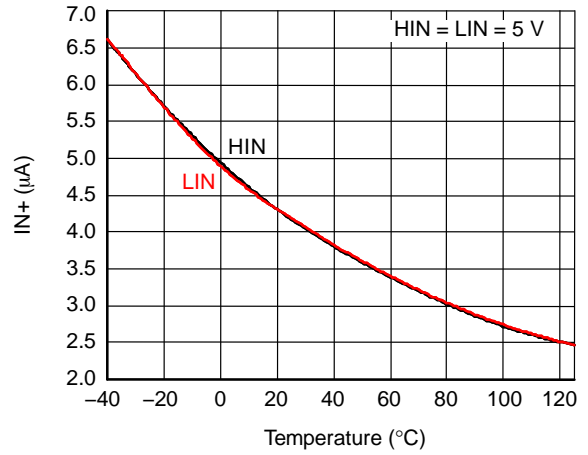

Figure 29. Input Bias Current vs. Temperature

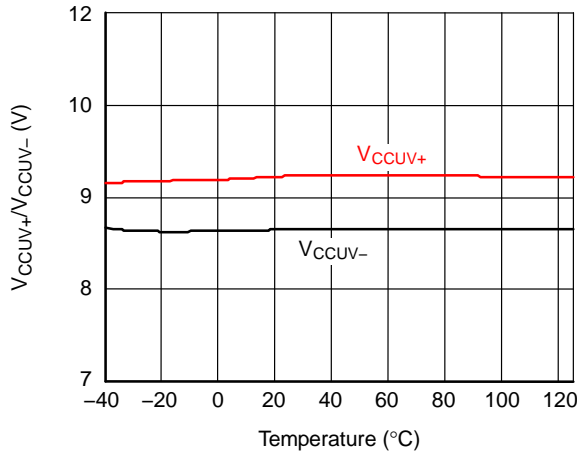

Figure 30. V_{CC} UVLO Threshold Voltage vs. Temperature

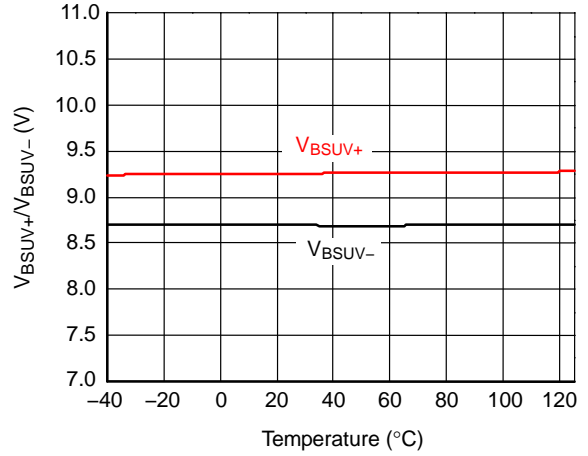

Figure 31. V_{BS} UVLO Threshold Voltage vs. Temperature

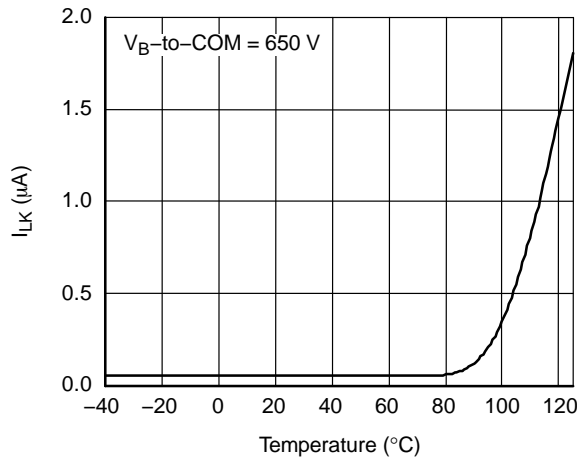

Figure 32. V_B to COM Leakage Current vs. Temperature

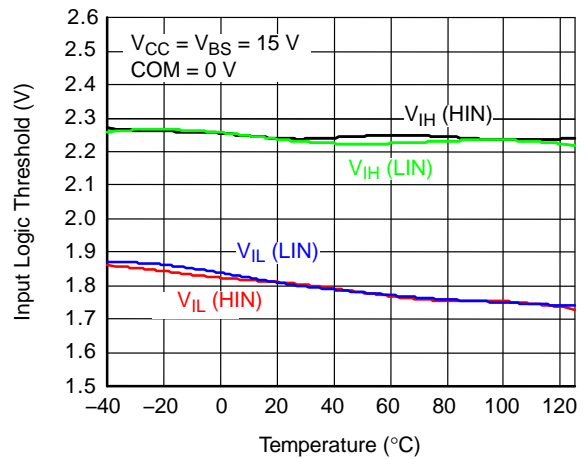

Figure 33. Input Logic Threshold vs. Temperature

FAN7380

SWITCHING TIME DEFINITIONS

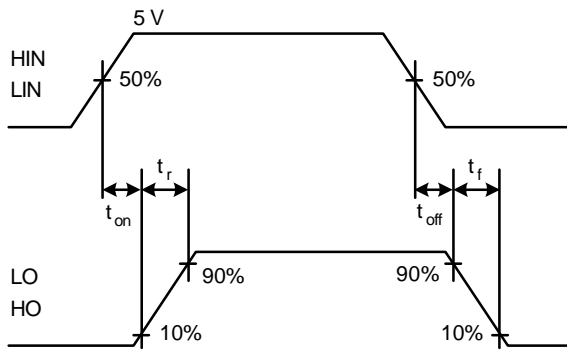

Figure 34. Switching Time Waveforms

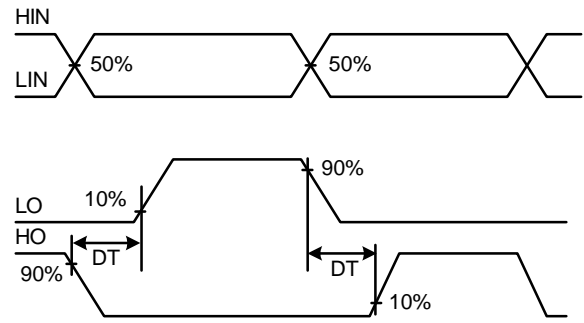

Figure 35. Internal Dead-Time Timing

ORDERING INFORMATION

Device	Package	Operating Temperature	Description	Shipping [†]
FAN7380MX (Note 5)	SOIC8 (8-SOP) (Pb-Free)	-40°C~+125°C	Lightning Application	3000 / Tape & Reel

5. This device has passed wave soldering test by JESD22A-111.

[†]For information on tape and reel specifications, including part orientation and tape sizes, please refer to our Tape and Reel Packaging Specifications Brochure, BRD8011/D.

MECHANICAL CASE OUTLINE
PACKAGE DIMENSIONS

ON Semiconductor®



SOIC8
CASE 751EG
ISSUE O

DATE 30 SEP 2016

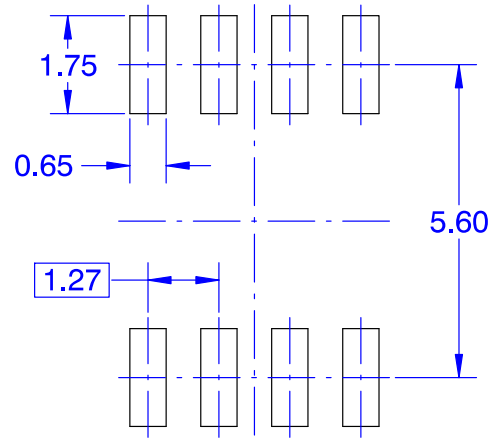

NOTES: UNLESS OTHERWISE SPECIFIED

- A. THIS PACKAGE CONFORMS TO JEDEC MS-012 VARIATION A EXCEPT WHERE NOTED.
- B. ALL DIMENSIONS ARE IN MILLIMETERS
- C. OUT OF JEDEC STANDARD VALUE
- D. DIMENSIONS ARE EXCLUSIVE OF BURRS, MOLD FLASH AND TIE BAR EXTRUSIONS.
- E. LAND PATTERN AS PER IPC SOIC127P600X175-8M

DOCUMENT NUMBER:	98AON13741G	Electronic versions are uncontrolled except when accessed directly from the Document Repository. Printed versions are uncontrolled except when stamped "CONTROLLED COPY" in red.
DESCRIPTION:	SOIC8	PAGE 1 OF 1

ON Semiconductor and are trademarks of Semiconductor Components Industries, LLC dba ON Semiconductor or its subsidiaries in the United States and/or other countries. ON Semiconductor reserves the right to make changes without further notice to any products herein. ON Semiconductor makes no warranty, representation or guarantee regarding the suitability of its products for any particular purpose, nor does ON Semiconductor assume any liability arising out of the application or use of any product or circuit, and specifically disclaims any and all liability, including without limitation special, consequential or incidental damages. ON Semiconductor does not convey any license under its patent rights nor the rights of others.

onsemi, **Onsemi**, and other names, marks, and brands are registered and/or common law trademarks of Semiconductor Components Industries, LLC dba "**onsemi**" or its affiliates and/or subsidiaries in the United States and/or other countries. **onsemi** owns the rights to a number of patents, trademarks, copyrights, trade secrets, and other intellectual property. A listing of **onsemi**'s product/patent coverage may be accessed at www.onsemi.com/site/pdf/Patent-Marking.pdf. **onsemi** reserves the right to make changes at any time to any products or information herein, without notice. The information herein is provided "as-is" and **onsemi** makes no warranty, representation or guarantee regarding the accuracy of the information, product features, availability, functionality, or suitability of its products for any particular purpose, nor does **onsemi** assume any liability arising out of the application or use of any product or circuit, and specifically disclaims any and all liability, including without limitation special, consequential or incidental damages. Buyer is responsible for its products and applications using **onsemi** products, including compliance with all laws, regulations and safety requirements or standards, regardless of any support or applications information provided by **onsemi**. "Typical" parameters which may be provided in **onsemi** data sheets and/or specifications can and do vary in different applications and actual performance may vary over time. All operating parameters, including "Typicals" must be validated for each customer application by customer's technical experts. **onsemi** does not convey any license under any of its intellectual property rights nor the rights of others. **onsemi** products are not designed, intended, or authorized for use as a critical component in life support systems or any FDA Class 3 medical devices or medical devices with a same or similar classification in a foreign jurisdiction or any devices intended for implantation in the human body. Should Buyer purchase or use **onsemi** products for any such unintended or unauthorized application, Buyer shall indemnify and hold **onsemi** and its officers, employees, subsidiaries, affiliates, and distributors harmless against all claims, costs, damages, and expenses, and reasonable attorney fees arising out of, directly or indirectly, any claim of personal injury or death associated with such unintended or unauthorized use, even if such claim alleges that **onsemi** was negligent regarding the design or manufacture of the part. **onsemi** is an Equal Opportunity/Affirmative Action Employer. This literature is subject to all applicable copyright laws and is not for resale in any manner.

PUBLICATION ORDERING INFORMATION

LITERATURE FULFILLMENT:

Email Requests to: orderlit@onsemi.com

onsemi Website: www.onsemi.com

TECHNICAL SUPPORT

North American Technical Support:
Voice Mail: 1 800-282-9855 Toll Free USA/Canada
Phone: 011 421 33 790 2910

Europe, Middle East and Africa Technical Support:

Phone: 00421 33 790 2910

For additional information, please contact your local Sales Representative

Mouser Electronics

Authorized Distributor

Click to View Pricing, Inventory, Delivery & Lifecycle Information:

[onsemi:](#)

[FAN7380MX](#) [FAN7380MX-WS](#)