

2842126-6 ✓ ACTIVE

AMPMODU | AMPMODU 2 mm

TE Internal #: 2842126-6

PCB Mount Header, Vertical, Board-to-Board, 12 Position, 2 mm [.079 in] Centerline, Breakaway, Gold, Through Hole - Solder, Signal, AMPMODU 2 mm

[View on TE.com >](#)



Connectors > PCB Connectors > PCB Headers & Receptacles

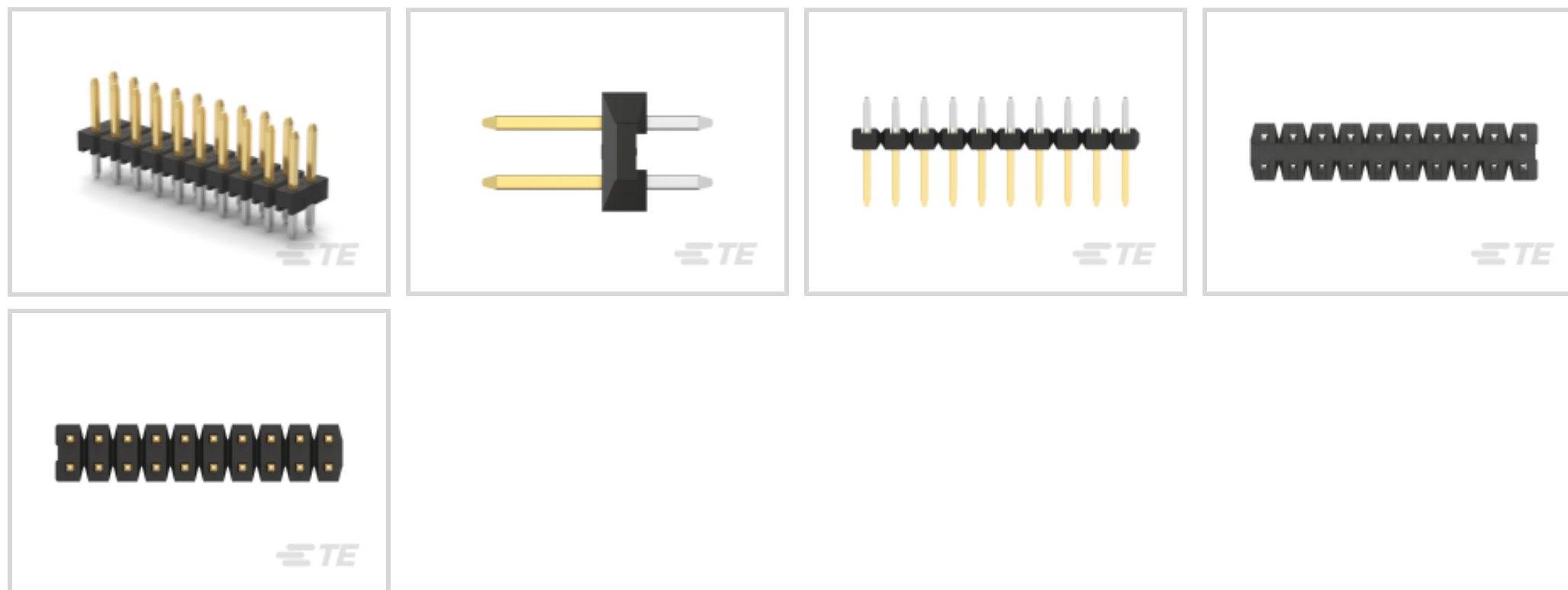

PCB Connector Assembly Type: **PCB Mount Header**

PCB Mount Orientation: **Vertical**

Connector System: **Board-to-Board**

Number of Positions: **12**

Number of Rows: **2**

Features

Product Type Features

PCB Connector Assembly Type	PCB Mount Header
Connector System	Board-to-Board
Header Type	Breakaway
Connector & Contact Terminates To	Printed Circuit Board

Configuration Features

Stackable	No
PCB Mount Orientation	Vertical
Number of Positions	12
Number of Rows	2

Electrical Characteristics

Dielectric Withstanding Voltage (Max)	500 VAC
Operating Voltage	125 VAC

Body Features

Connector Profile	Standard
-------------------	----------



Primary Product Color	Black
-----------------------	-------

Contact Features

Contact Mating Area Length	4 mm[.157 in]
Mating Square Post Dimension	.5 mm[.02 in]
PCB Contact Termination Area Plating Material Thickness	2 μ m[78.74 μ in]
Contact Layout	Inline
Contact Underplating Material Thickness	.5 μ m[19.69 μ in]
PCB Contact Termination Area Plating Material Finish	Bright
Contact Shape & Form	Square
Contact Underplating Material	Nickel
PCB Contact Termination Area Plating Material	Tin
Contact Base Material	Brass
Contact Mating Area Plating Material	Gold
Contact Mating Area Plating Material Thickness	.1 μ m[3.94 μ in]
Contact Type	Pin
Contact Current Rating (Max)	2 A

Termination Features

Square Termination Post & Tail Dimension	.5 mm[.02 in]
Termination Post & Tail Length	2.8 mm[.11 in]
Termination Method to Printed Circuit Board	Through Hole - Solder

Housing Features

Centerline (Pitch)	2 mm[.079 in]
Housing Material	PA9T GF

Dimensions

Connector Length	12 mm[.472 in]
Connector Width	4 mm[.157 in]
Row-to-Row Spacing	2 mm[.079 in]
PCB Thickness (Recommended)	1.6 mm[.063 in]

Usage Conditions

Housing Temperature Rating	High
Operating Temperature Range	-40 – 125 °C[-40 – 257 °F]

Operation/Application



Assembly Process Feature	Without Pick and Place Cover
--------------------------	------------------------------

Circuit Application	Signal
---------------------	--------

Industry Standards

UL Rating	Recognized
-----------	------------

Agency/Standard	UL
-----------------	----

Approved Standards	UL E28476
--------------------	-----------

UL Flammability Rating	UL 94V-0
------------------------	----------

Packaging Features

Packaging Type	Tube
----------------	------

Product Compliance

[For compliance documentation, visit the product page on TE.com>](#)

EU RoHS Directive 2011/65/EU	Compliant
------------------------------	-----------

EU ELV Directive 2000/53/EC	Compliant
-----------------------------	-----------

China RoHS 2 Directive MIIT Order No 32, 2016	No Restricted Materials Above Threshold
---	---

EU REACH Regulation (EC) No. 1907/2006	Current ECHA Candidate List: JAN 2023 (233) Candidate List Declared Against: JAN 2023 (233) Does not contain REACH SVHC
--	---

Halogen Content	Not Low Halogen - contains Br or Cl > 900 ppm.
-----------------	--

Solder Process Capability	Reflow solder capable to 260°C
---------------------------	--------------------------------

Product Compliance Disclaimer

This information is provided based on reasonable inquiry of our suppliers and represents our current actual knowledge based on the information they provided. This information is subject to change. The part numbers that TE has identified as EU RoHS compliant have a maximum concentration of 0.1% by weight in homogenous materials for lead, hexavalent chromium, mercury, PBB, PBDE, DBP, BBP, DEHP, DIBP, and 0.01% for cadmium, or qualify for an exemption to these limits as defined in the Annexes of Directive 2011/65/EU (RoHS2). Finished electrical and electronic equipment products will be CE marked as required by Directive 2011/65/EU. Components may not be CE marked. Additionally, the part numbers that TE has identified as EU ELV compliant have a maximum concentration of 0.1% by weight in homogenous materials for lead, hexavalent chromium, and mercury, and 0.01% for cadmium, or qualify for an exemption to these limits as defined in the Annexes of Directive 2000/53/EC (ELV). Regarding the REACH Regulation, the information TE provides on SVHC in articles for this part number is based on the latest European Chemicals Agency (ECHA) 'Guidance on requirements for substances in articles' posted at this URL: <https://echa.europa.eu/guidance-documents/guidance-on-reach>

Compatible Parts

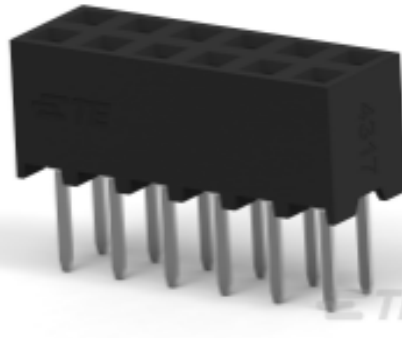
TE Part # 1-2314812-2
12P,2MM,B-B,REC,DRV,T,2.0,0.1AU,TB, W/CAP

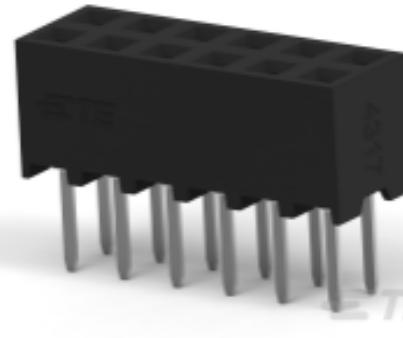

TE Part # 1-2314820-2
12P,2MM,B-B,REC,DRV,T,2.7,0.1AU,TB



TE Part # 1-2314824-2
12P,2MM,B-B,REC,DRV,T,2.7,0.1AU,TB, W/CAP



TE Part # 1-2316108-2
12P,2MM,REC,HSG,DR,CRIMP,PLAIN, BOX



TE Part # 1-2314940-2
12P,2MM,B-B,REC,DRHZ,SMD,0.1AU, TB



TE Part # 1-2307729-2
12P,2MM,B-B,REC,DRHZ,SMD,0.1AU, TR

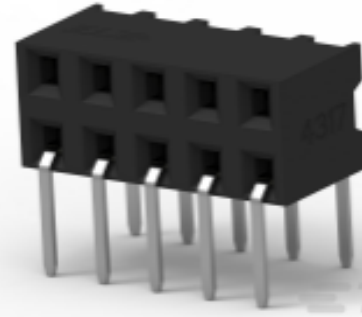

TE Part # 1-2314916-2
12P,2MM,B-B,REC,DRHZ,2.1,0.1AU,TB

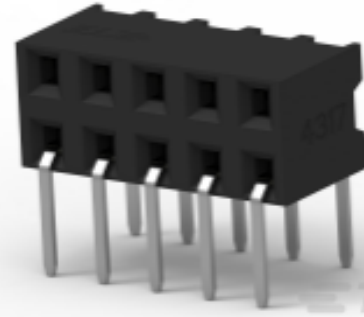

TE Part # 1-2307715-2
12P,2MM,B-B,REC,DRHZ,2.1,0.1AU,TR

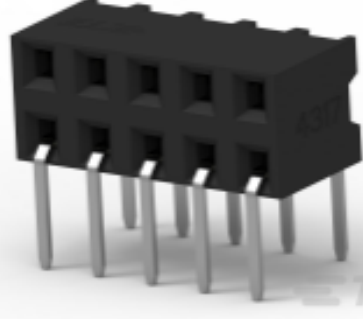

TE Part # 1-2307716-2
12P,2MM,B-B,REC,DRHZ,2.8,0.1AU,TB

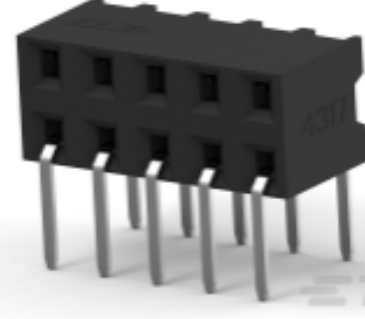

TE Part # 1-2314924-2
12P,2MM,B-B,REC,DRHZ,2.8,0.1AU,TR



TE Part # 1-2307717-2
12P,2MM,B-B,REC,DRHZ,3.4,0.1AU, TUBE



TE Part # 1-2314844-2
12P,2MM,B-B,REC,DRV,T,SMD,0.1AU, TB,W/CP



TE Part # 1-2307817-2
12P,2MM,BB,REC,DRV,T,SMD,0.1AU, TR,W/CP



TE Part # 1-2307779-2
12P,2MM,B-B,REC,DRV,T,2.0,0.1AU,TR, W/CAP



TE Part # 1-2307780-2
12P,2MM,B-B,REC,DRV,T,2.7,0.1AU,TR, W/CAP

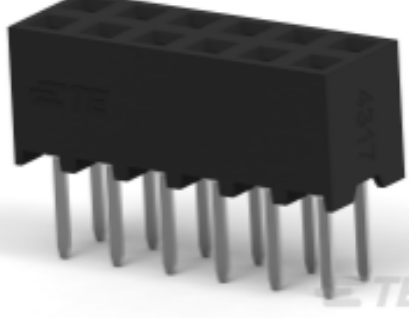

TE Part # 1-2307781-2
12P,2MM,B-B,REC,DRV,T,3.2,0.1AU, TUBE



TE Part # 1-2314852-2
12P,2MM,BB,REC,DRV,T,OTR,2.3,AU.1, TB,W/CP



TE Part # 1-2307823-2
12P,2MM,BB,REC,DRV,T,OTR,2.3,AU.1, TR,W/CP



TE Part # 1-2314860-2
12P,2MM,B-B,REC,DRV,T,OTR,2.8,0.1 AU,TB



TE Part # 1-2314864-2
12P,2MM,BB,REC,DRV,T,OTR,2.8,AU.1, TB W/CP

Also in the Series | **AMPMODU 2 mm**

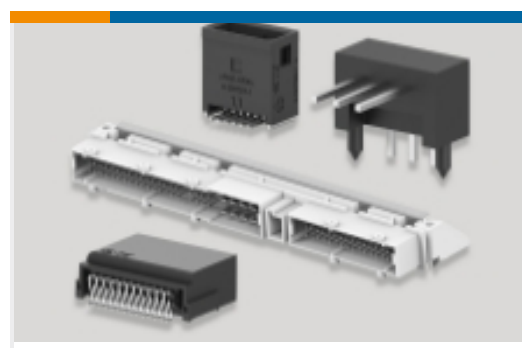

PCB Headers & Receptacles(8510)

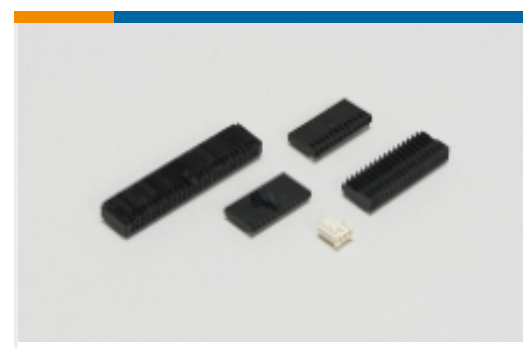

Wire-to-Board Connector Assemblies & Housings(202)



Wire-to-Board Connector Contacts(27)

Customers Also Bought

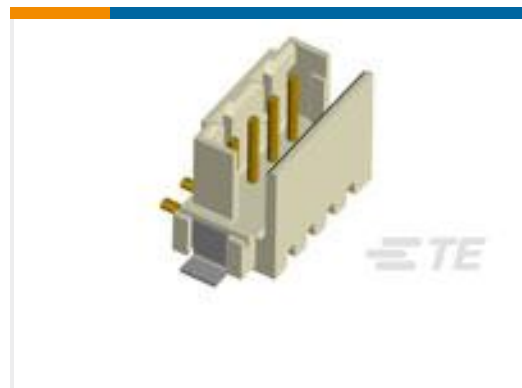
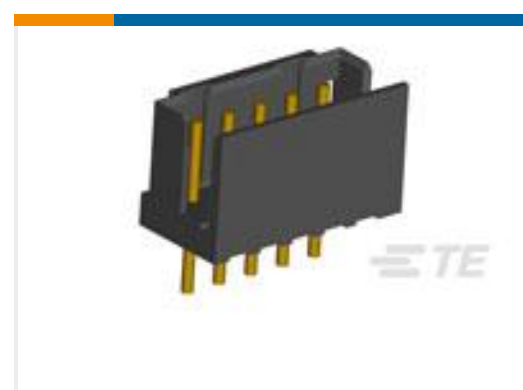
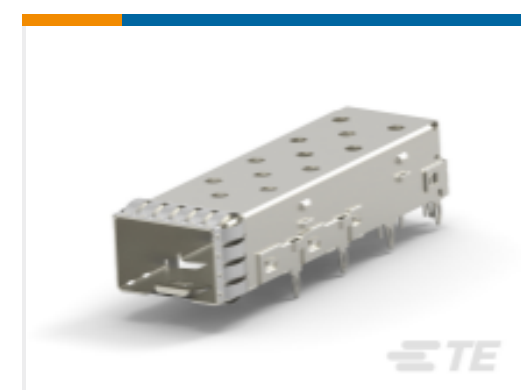
TE Part #292175-5
CT BOX HDR V SMT 5P O/TAPE NATTE Part #2-1879378-9
TLR 2512 1.0W R0015 1% 50PPM 2K RLTE Part #2842102-2
2P,2MM,BRK HDR,SRVT,SMD,0.1AU,
TR W/CAPTE Part #2337238-3
TACT MINI GW 5.2X5.2X2 160GFTE Part #4-2176362-2
RQ 0402 107R 0.1% 10PPM 5K RLTE Part #1-292133-2
CT P/HDR ASSY BOX V 12P W/O KITE Part #2-1437514-0
322-HCS5P2-100=HOLTITE CNTTE Part #2317434-1
SFP+ 1x1 Cage Assy, PCI, Press

Documents

Product Drawings

12P,2MM,BRK HDR,DRVT,2.8,0.1AU,TB

English

CAD Files

3D PDF

3D

Customer View Model

[ENG_CVM_CVM_2842126-6_A.2d_dxf.zip](#)

English

Customer View Model

[ENG_CVM_CVM_2842126-6_A.3d_igs.zip](#)

English

Customer View Model

[ENG_CVM_CVM_2842126-6_A.3d_stp.zip](#)

English

By downloading the CAD file I accept and agree to the [Terms and Conditions](#) of use.



[Product Specifications](#)

[Application Specification](#)

English