

Not Recommended for New Designs

VIPAC Array™

POWER SYSTEMS CONFIGURATION GUIDE

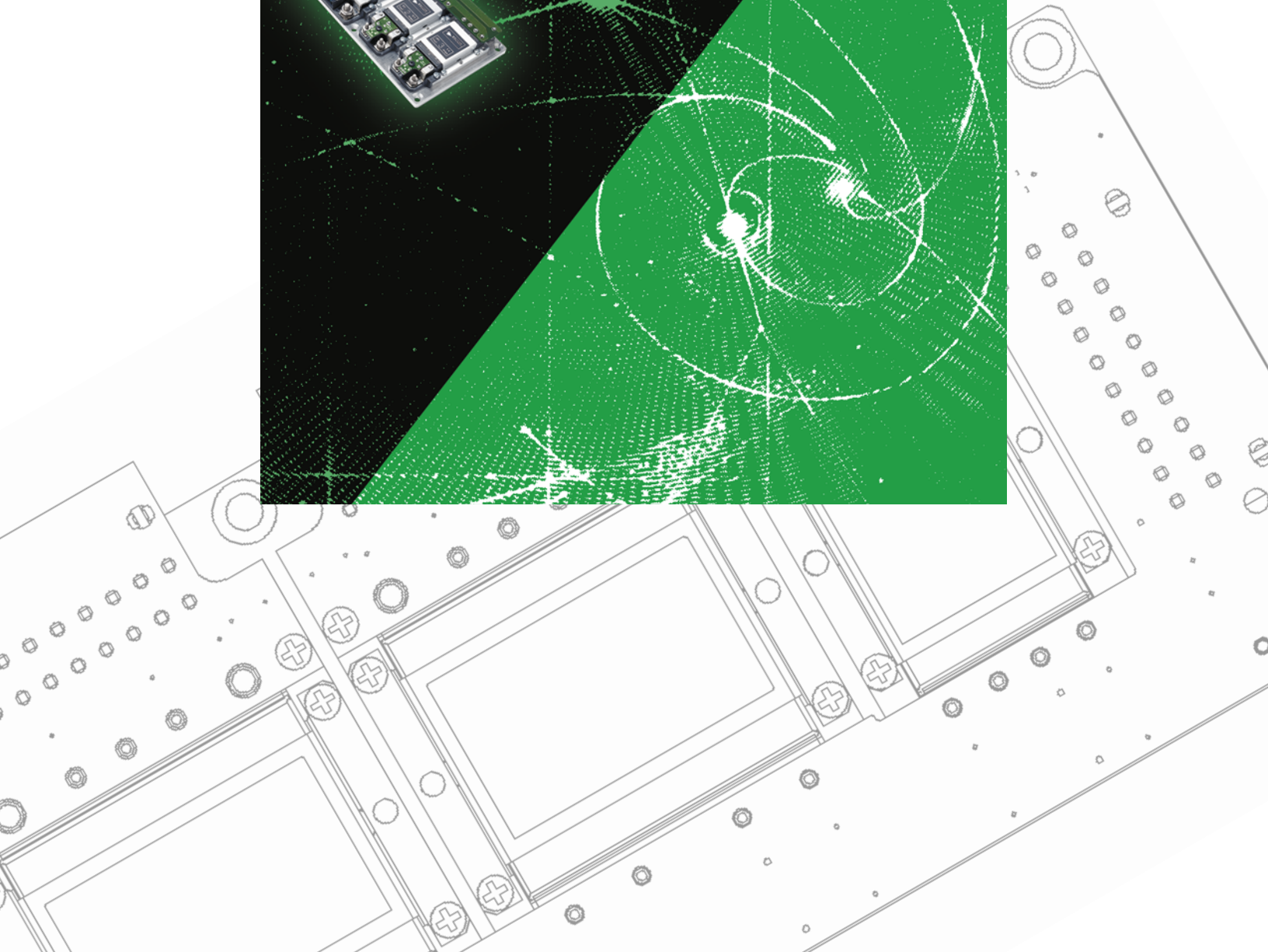
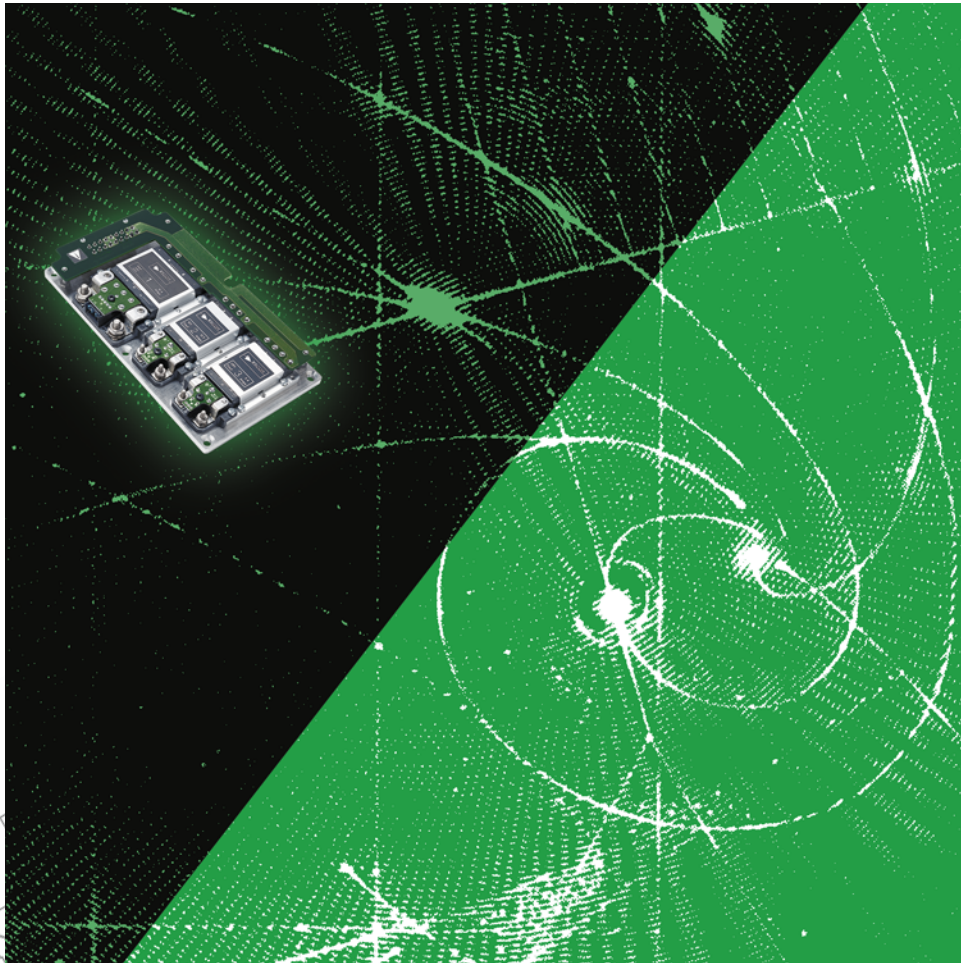

CONTENTS

2-3	PRODUCT OVERVIEW
4-6	INPUT AND OUTPUT CONNECTIONS
7	MOUNTING OPTIONS
8-11	MECHANICAL DRAWINGS
12	TECHNICAL SUPPORT CONTACTS

PRODUCT OVERVIEW

The VIPAC Array is a highly flexible system of DC input, power building-blocks that can be configured with as many as four user definable outputs on a low profile, coldplate chassis. VIPAC Array offers the convenience of a prepackaged, chassis mount solution with the performance and power density of Vicor's Maxi, Mini, Micro Series modules, DC-DC converters.

Using Vicor's VCAD configuration tool, (vicorpower.com/vcad), designers are able to quickly specify VIPAC Arrays with standard inputs of 24, 28, 48, 72, 110, 150, 300 or 375 Vdc and standard outputs from 2 to 48 Vdc at power levels up to 600 Watts per output. A total of 8 standard chassis configurations offers the user a choice of power and mechanical options to fit most designs. Short cycle time and rapid delivery make VIPAC Array a valuable tool for power system prototyping and development efforts as well.

For technical information refer to "Design Guide & Applications Manual for Maxi, Mini, Micro Family DC-DC Converters and Accessory Modules"

VIPAC Arrays are ideal for use in distributed and modular power systems where power density and reliable operation are critical. A current share option is available on single output models enabling them to be used in applications requiring either redundant operation or kilowatts of power. The 300 and 375 Vdc input versions can be coupled to a bulk AC Front-end to create a modular, scaleable power supply serving a variety of power architectures from centralized to distributed. VIPAC Arrays include internal fusing, a global enable / disable function and connectorized input and output terminations to speed system installation while a versatile coldplate chassis simplifies thermal management and mounting.

Vicor's VCAD configuration tool provides expedited part configuration, part number, price and delivery information by selecting standard Maxi, Mini, and Micro modules for use within the VIPAC Array based on the application requirements. The modules are chosen based on the input and output requirements and the closest, but higher power level that is available to that specified. Specifications for these can be found on their respective data sheets.

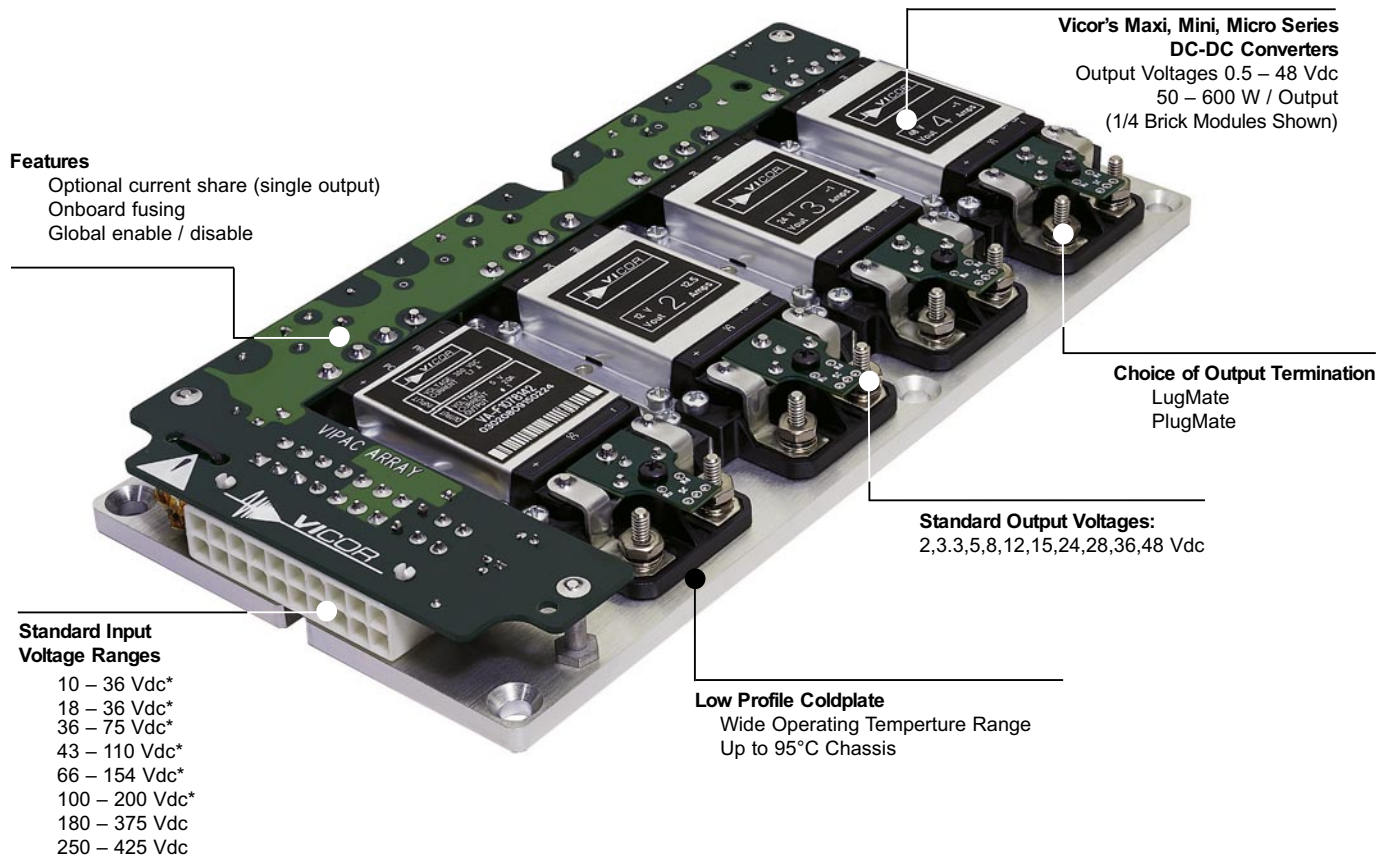

* Note: 24, 28, 48, 72, 110, and 150 V input VIPAC Arrays are designed primarily for military COTS and industrial applications and do not carry safety agency approvals.

Product Overview



VA-A

2 MINIS

- 3.62" x 6.69" x 0.78"^[a]
(92,0 x 170,0 x 19,8 mm)
- 1.3 lb (590 g)
- Single or dual output
- Up to 600 W

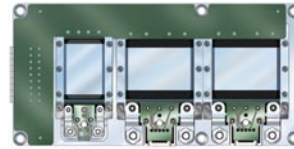

VA-E

1 MICRO, 2 MINIS

- 3.62" x 7.52" x 0.78"^[a]
(92,0 x 191,0 x 19,8 mm)
- 1.4 lb (635 g)
- Dual or triple outputs
- Up to 750 W total

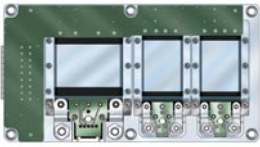

VA-B

1 MINI, 2 MICROS

- 3.62" x 6.69" x 0.78"^[a]
(92,0 x 170,0 x 19,8 mm)
- 1.3 lb (590 g)
- Single, dual or triple outputs
- Up to 600 W total

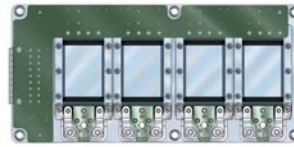

VA-F

4 MICROS

- 3.62" x 7.52" x 0.76"^[a]
(92,0 x 191,0 x 19,3 mm)
- 1.3 lb (608 g)
- Dual, triple or quad outputs
- Up to 600 W total

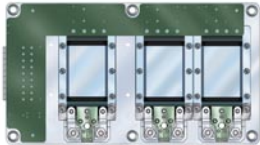

VA-C

3 MICROS

- 3.62" x 6.69" x 0.76"^[a]
(92,0 x 170,0 x 19,3 mm)
- 1.1 lb (499 g)
- Dual or triple outputs
- Up to 450 W total

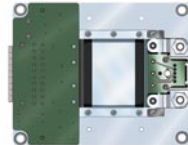

VA-G/K

1 MINI

- 3.62" x 4.39" x 0.78"^[a]
(92,0 x 112,0 x 19,8 mm)
- 0.7 lb (318 g)
- Single output
- Up to 300 W
- Current share option

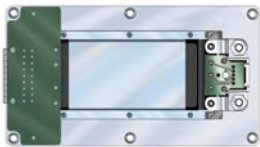

VA-D/J

1 MAXI

- 3.62" x 6.69" x 0.78"^[a]
(92,0 x 170,0 x 19,8 mm)
- 1.1 lb (499 g)
- Single output
- Up to 600 W
- Current share option

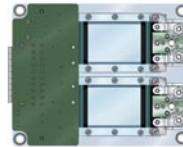

VA-H

2 MICROS

- 3.62" x 4.39" x 0.78"^[a]
(92,0 x 112,0 x 19,8 mm)
- 0.7 lb (318 g)
- Single or dual outputs
- Up to 300 W

^[a] PlugMate version is 0.81" (20,5 mm) in height

Note: Output numbering convention left to right facing output connections.

Model #'s and total output power capabilities are determined using VCAD and are application specific.

Input / Output Connections

J1 Input Connector (View looking into J1)

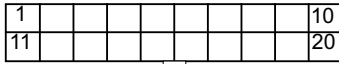

Pin#	Funct.
1-4	-Vin
5-7	+Vin
8	NC / PR bus
9	PE protective earth
10	Neg. enable
11-13	-Vin
14-17	+Vin
18	NC / PR bus
19	PE protective earth
20	Pos. enable

VA-J and VA-K configurations only
(300 and 375 Vin single Maxi or single Mini)

Pin#	Funct.
1-3	-Vin
4-6	+Vin
7	NC
8	NC / PR bus
9	PE protective earth
10	Neg. enable
11-13	-Vin
14-16	+Vin
17	NC
18	NC / PR bus
19	PE protective earth
20	Pos. enable

To disable output(s) apply +5 Vdc between pins 10 and 20 in the polarity indicated

Mating Connector

	Vicor part #	TE Connectivity part #
Housing		2-794657-0
Contacts		1-106529-2
Kit	24828	

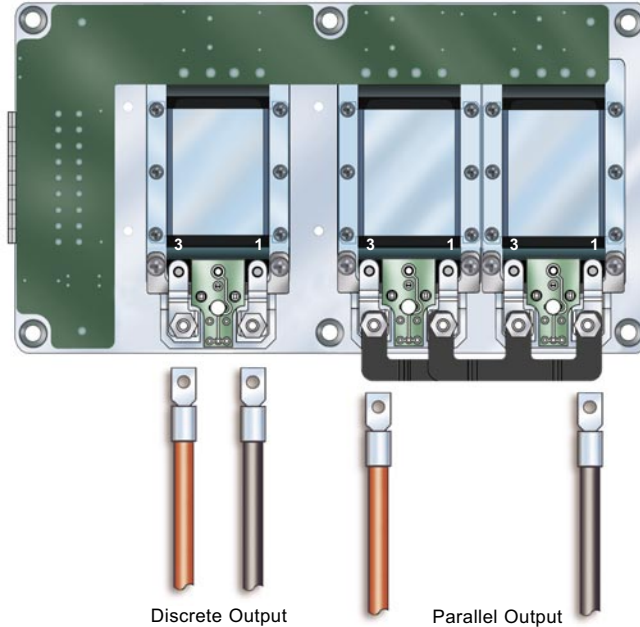

Shown with the output(s) of two modules connected in parallel using factory installed bus bar.**

Factory installed Micro LugMate

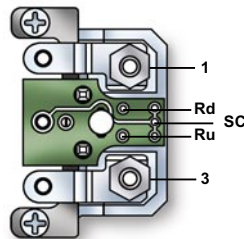

Pin #	Solder Pad	Function
1		- Vout
	Rd	Trim Down
	SC	Secondary Control
	Ru	Trim Up
3		+ Vout

Consult design calculator for Rd/Ru trim resistor values located at vicorpower.com

Factory installed Mini/Maxi LugMate

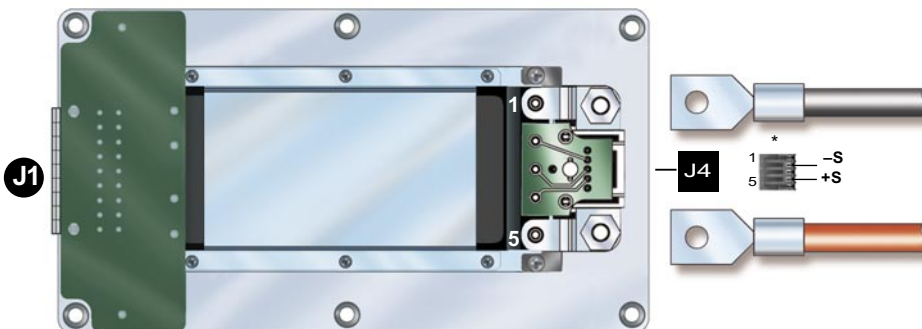

Pin #	Conn.	Function	Mating Conn.
1		- Vout	
	J4-1	- Vout	TE Connectivity 644083-5
	J4-2	- Sense	
	J4-3	Secondary Control	
	J4-4	+ Sense	
	J4-5	+ Vout	
5		+ Vout	

*Removable jumpers in J4 are factory installed for local sensing. For remote sensing the +Sense pins should be tied to the same point on the +Out power bus; the -Sense pins should be tied to the same point the - Out power bus.

Not Recommended for New Designs

Parallel^{***} / Redundant Connections^{*}

J1 Input Connector (View looking into J1)

1										10
11										20

Pin#	Funct.
1-4	-Vin
5-7	+Vin
8	NC / PR bus
9	PE protective earth
10	Neg. enable
11-13	-Vin
14-17	+Vin
18	NC / PR bus
19	PE protective earth
20	Pos. enable

VA-J and VA-K configurations only
(300 and 375 Vin single Maxi or single Mini)

Pin#	Funct.
1-3	-Vin
4-6	+Vin
7	NC
8	NC / PR bus
9	PE protective earth
10	Neg. enable
11-13	-Vin
14-16	+Vin
17	NC
18	NC / PR bus
19	PE protective earth
20	Pos. enable

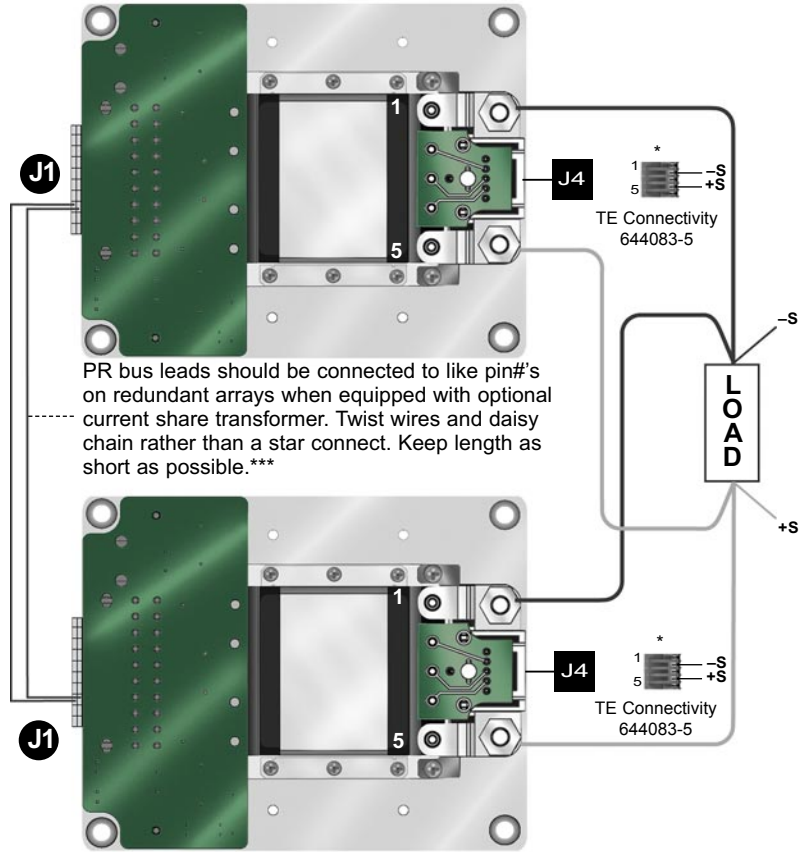

Factory installed Mini/Maxi LugMate

To disable output(s) apply +5 Vdc between pins 10 and 20 in the polarity indicated

Mating Connector

	Vicor part #	TE Connectivity part #
Housing		2-794657-0
Contacts		1-106529-2
Kit	24828	

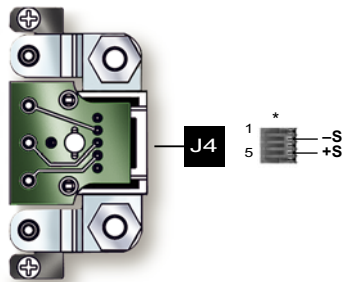

Pin #	Conn.	Function	Mating Conn.
1		- Vout	
	J4-1	- Vout	TE Connectivity 644083-5
	J4-2	- Sense	
	J4-3	Secondary Control	
	J4-4	+ Sense	
	J4-5	+ Vout	
5		+ Vout	

* Removable jumpers in J4 are factory installed for local sensing. For remote sensing and redundant parallel arrays as illustrated above the +Sense pins should be tied to the same point on the +Out power bus; the -Sense pins should be tied to the same point the -Out power bus.

** There should be one parent module, this is realized by choosing one module to be the parent and shorting the SC to -S on the other module. Units configured from the factory as paralleled will already have this configured. This should be verified by direct inspection prior to system integration.

*** There should be one parent module, this is realized by choosing one module to be the parent and shorting the SC to -S on the other module. This is done by installing a 0Ω resistor in the space provided on the lugmate / plugmate.

OUTPUT CONNECTION OPTIONS

PlugMate (Factory Installed Option)

Mating Connector Kits

Micro PlugMate

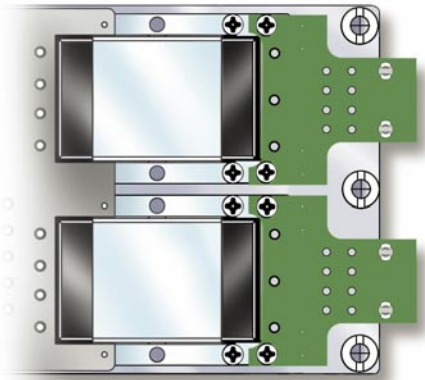

Vicor kit P/N 25073

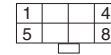

Pin #	Function	Pin #	Function
1	+Vout	5	+Vout
2	+Vout	6	N/C
3	-Vout	7	SC
4	-Vout	8	-Vout

Mating Connector	TE Connectivity P/N	Vicor P/N
Housing	TYC-794657-8	
Pin Kit	1-106529-2	25073

Mini PlugMate

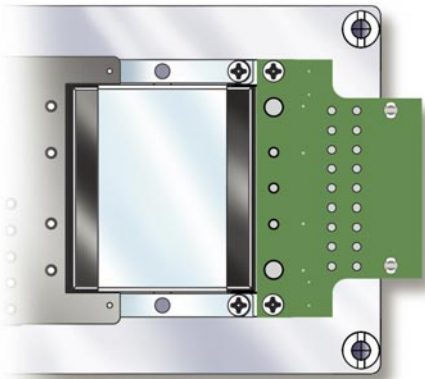

Vicor kit P/N 25067



Pin #	Function	Pin #	Function
1	+Vout	10	+Vout
2	+Vout	11	+Vout
3	+Vout	12	+Vout
4	N/C	13	+S
5	N/C	14	SC
6	N/C	15	-S
7	-Vout	16	-Vout
8	-Vout	17	-Vout
9	-Vout	18	-Vout

Mating Connector	TE Connectivity P/N	Vicor P/N
Housing	TYC1-794657-8	
Pin Kit	1-106529-2	25067

Maxi PlugMate

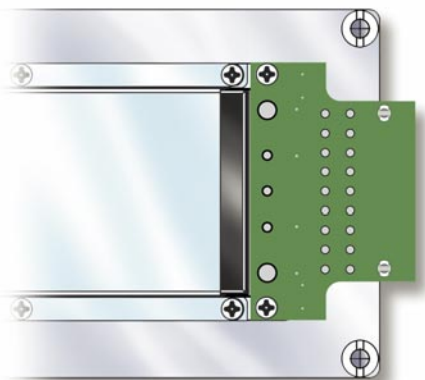

Vicor kit P/N 25061



Pin #	Function	Pin #	Function
1	+Vout	13	+Vout
2	+Vout	14	+Vout
3	+Vout	15	+Vout
4	+Vout	16	+Vout
5	+Vout	17	+Vout
6	N/C	18	+S
7	SC	19	-S
8	-Vout	20	-Vout
9	-Vout	21	-Vout
10	-Vout	22	-Vout
11	-Vout	23	-Vout
12	-Vout	24	-Vout

Mating Connector	TE Connectivity P/N	Vicor P/N
Housing	TYC2-794657-4	
Pin Kit	1-106529-2	25061

Please Note:
VIPACs that contain multiple modules configured as a single output (paralleled for power or redundancy) **MUST** have their Outputs and Sense connected to each other at the load. **DO NOT OPERATE A PARALLEL CONFIGURATION WITH ONLY ONE MODULE CONNECTED.** Additionally one module must be designated as "parent" by having all other modules configured as "Boosters". Boosters are created by shorting the SC pin to -S.

Mounting Options

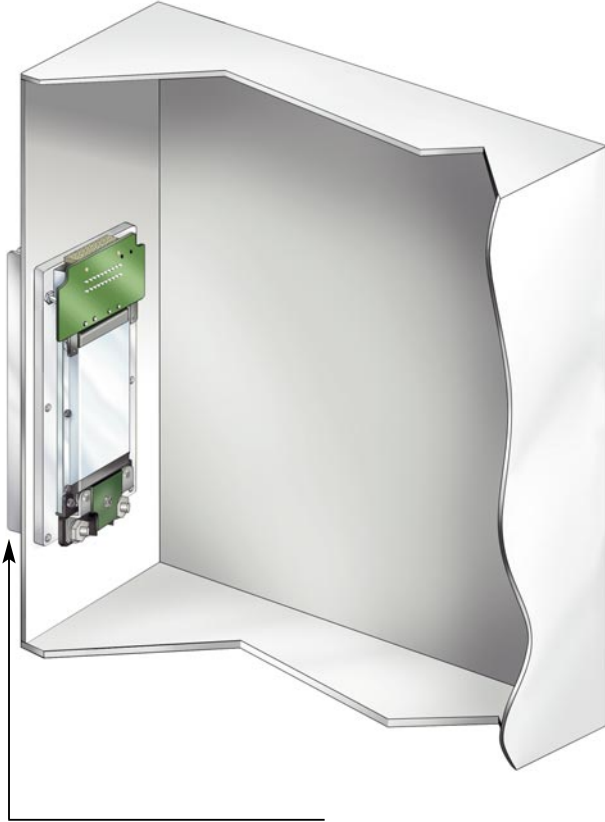

VIPAC Array with external, user supplied heat sink.

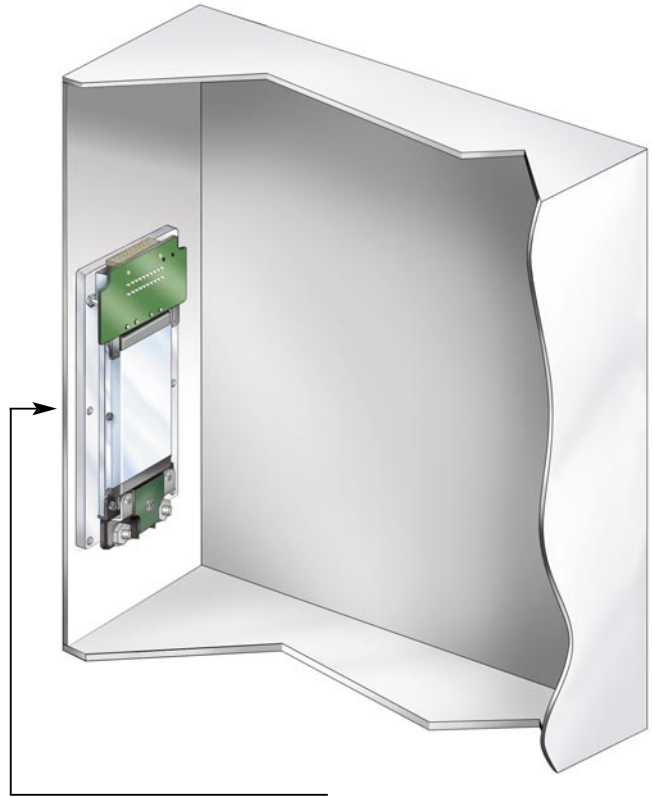

VIPAC Array mounted to cabinet wall with thermal compound between VIPAC Array and cabinet wall.

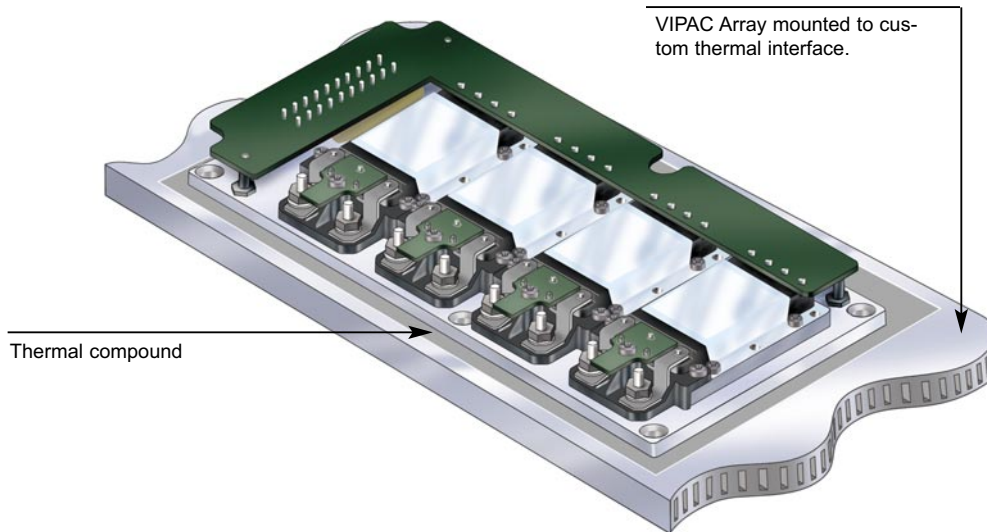

Thermal compound

VIPAC Array mounted to custom thermal interface.

MECHANICAL DRAWINGS

Coldplate thickness is 0.19" ref for all configurations.

Configuration A

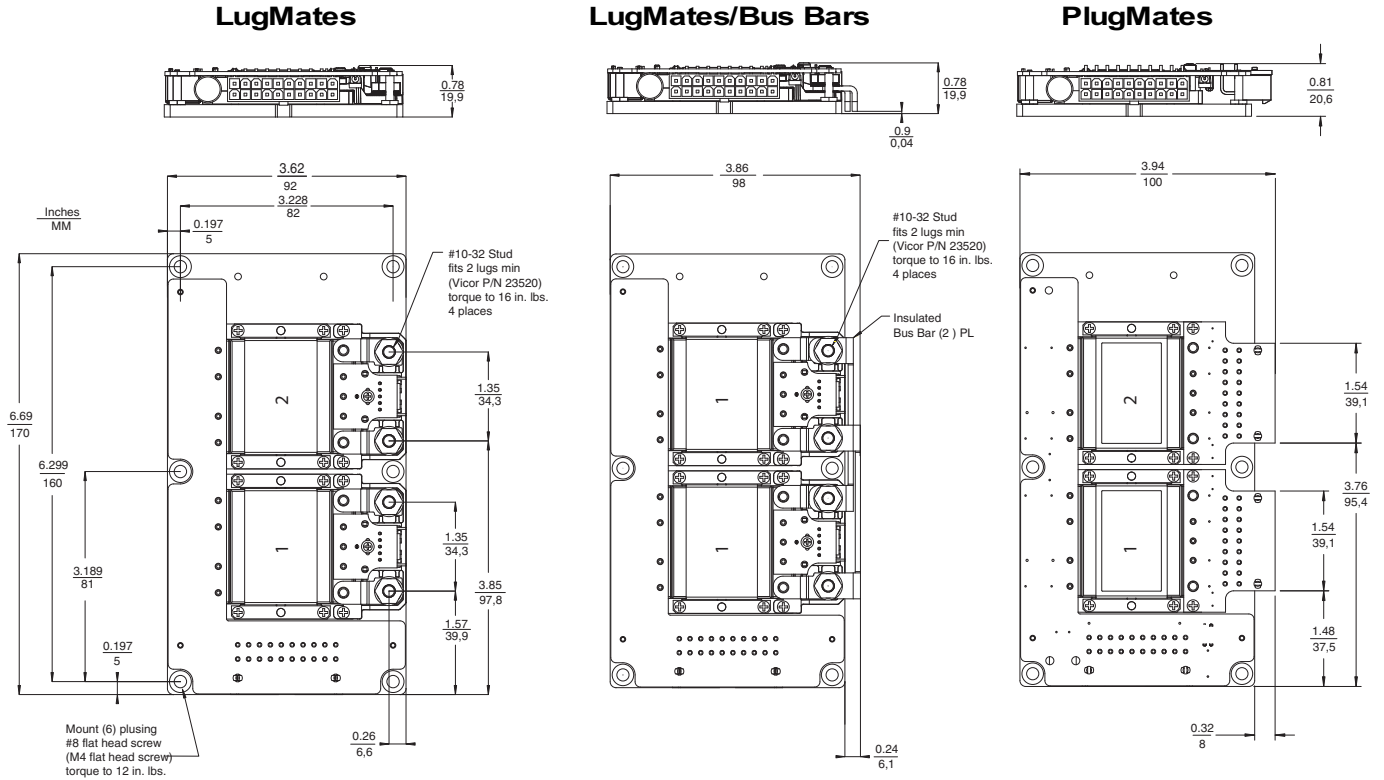

Configuration B

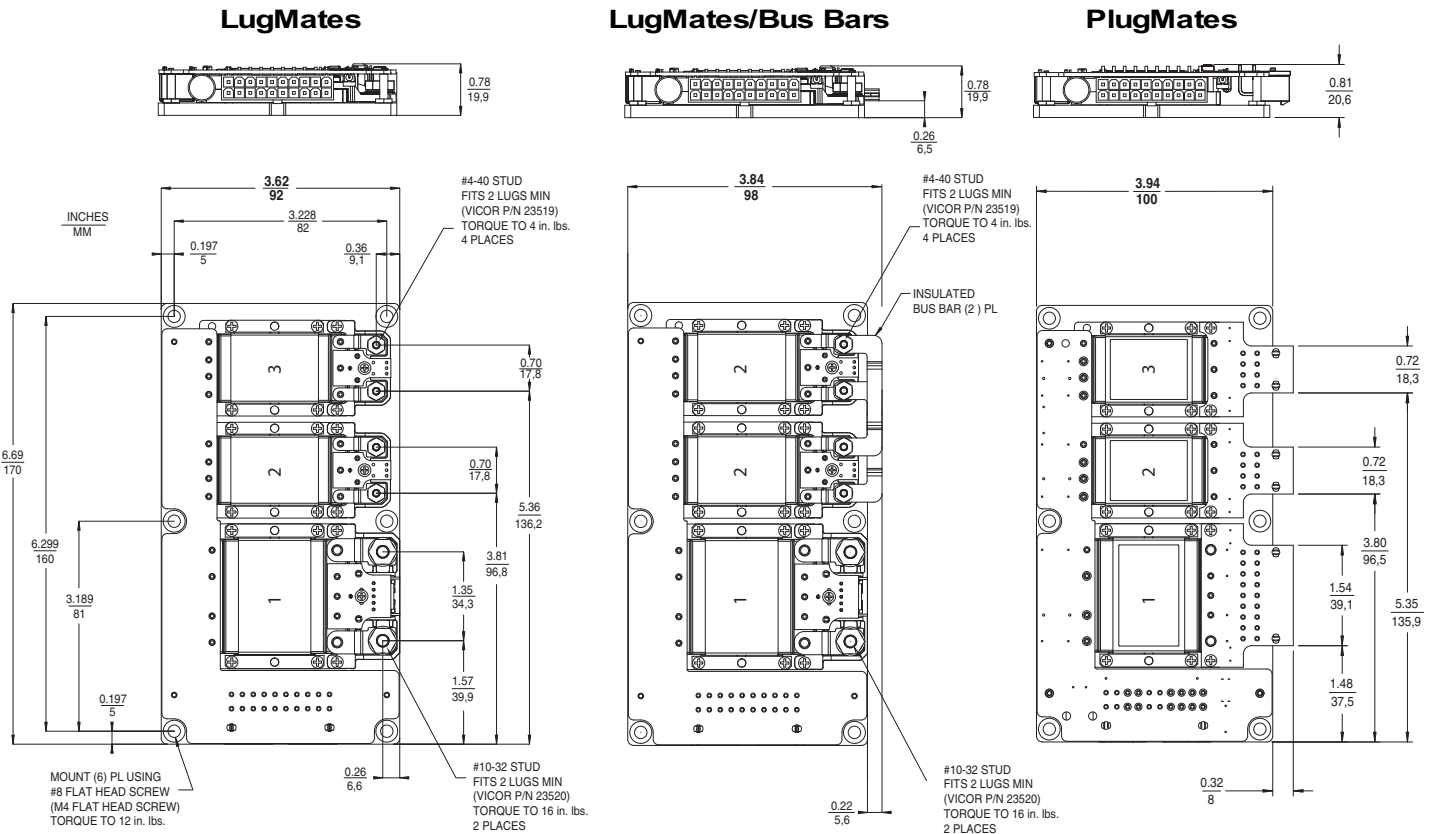

Not Recommended for New Designs

MECHANICAL DRAWINGS

Configuration C

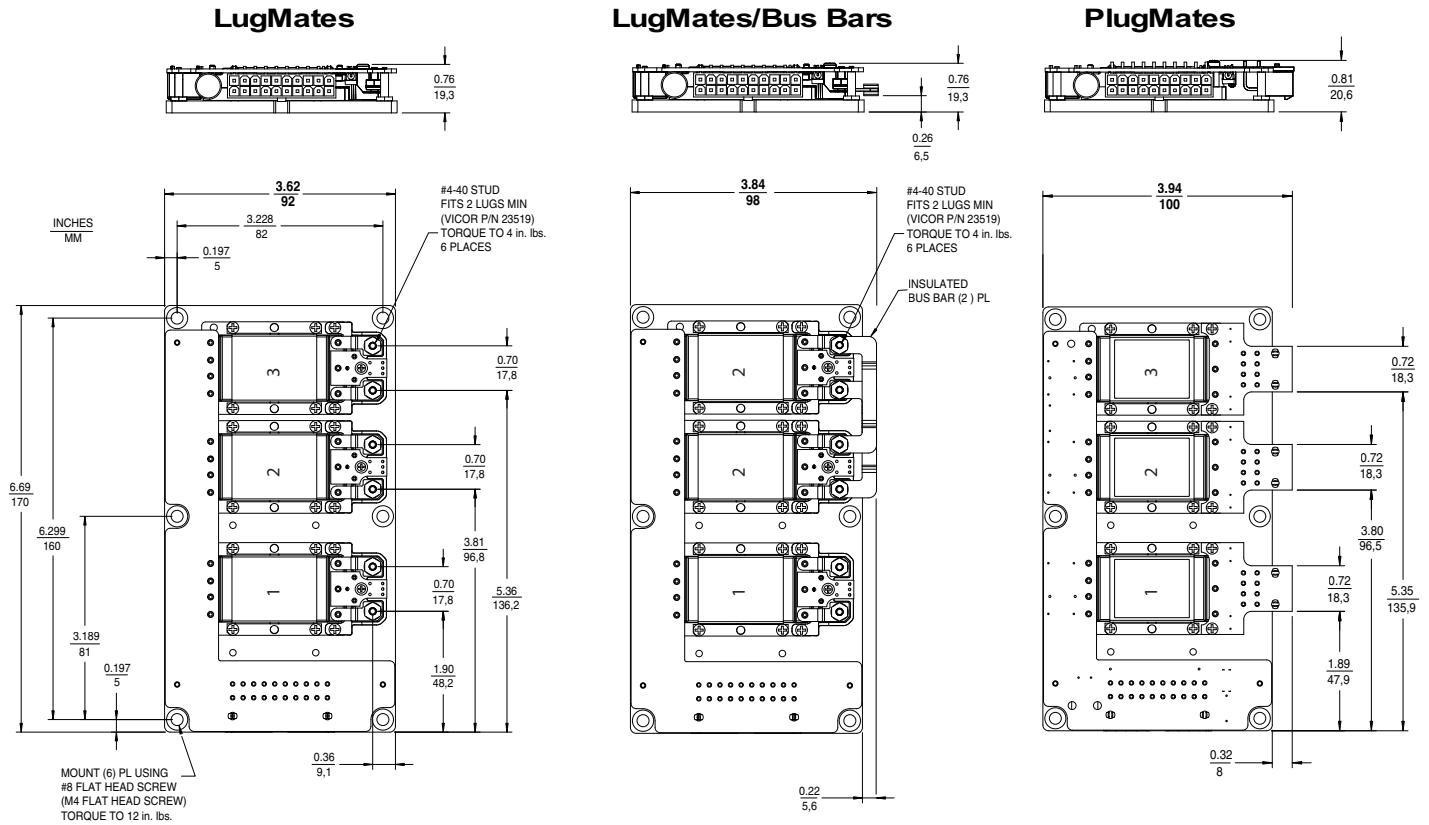

Configuration D and J

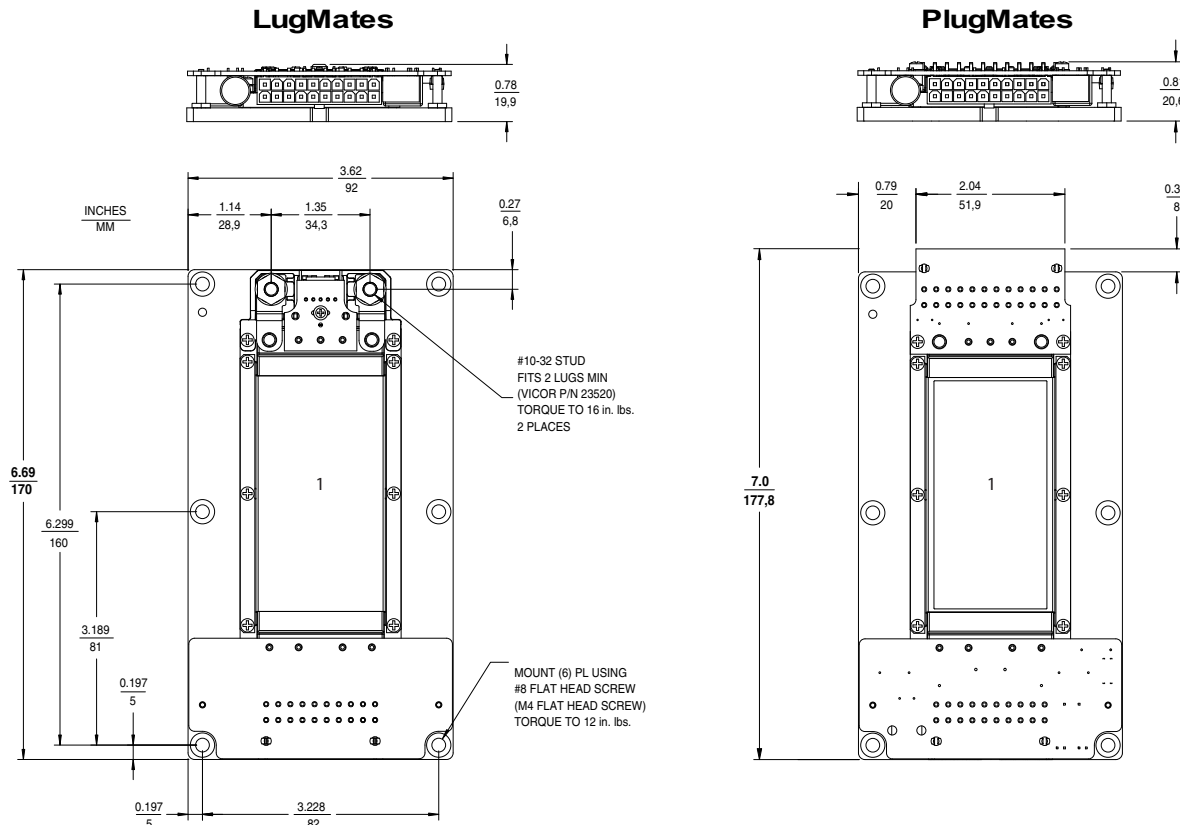

MECHANICAL DRAWINGS

Configuration E

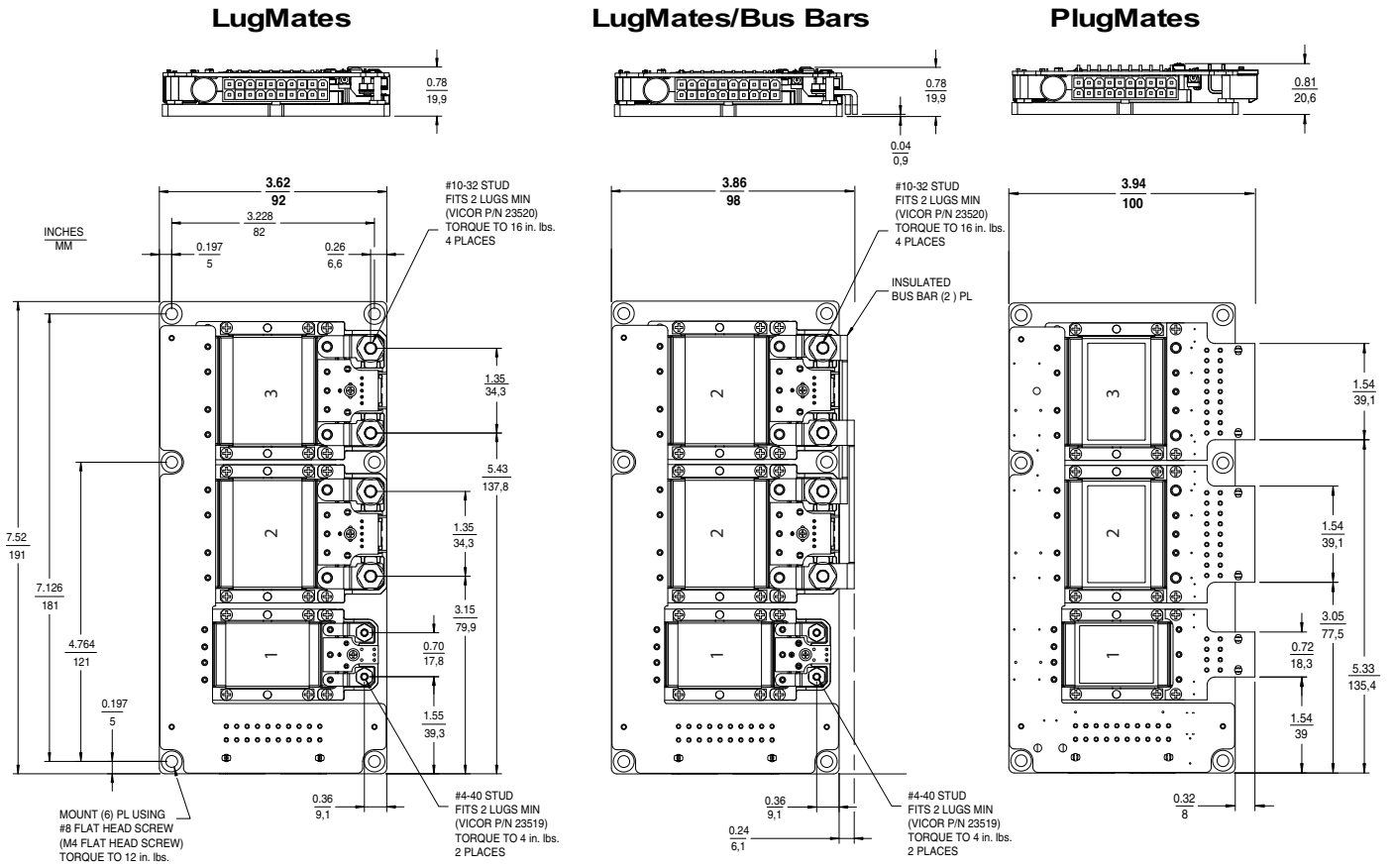

Configuration F

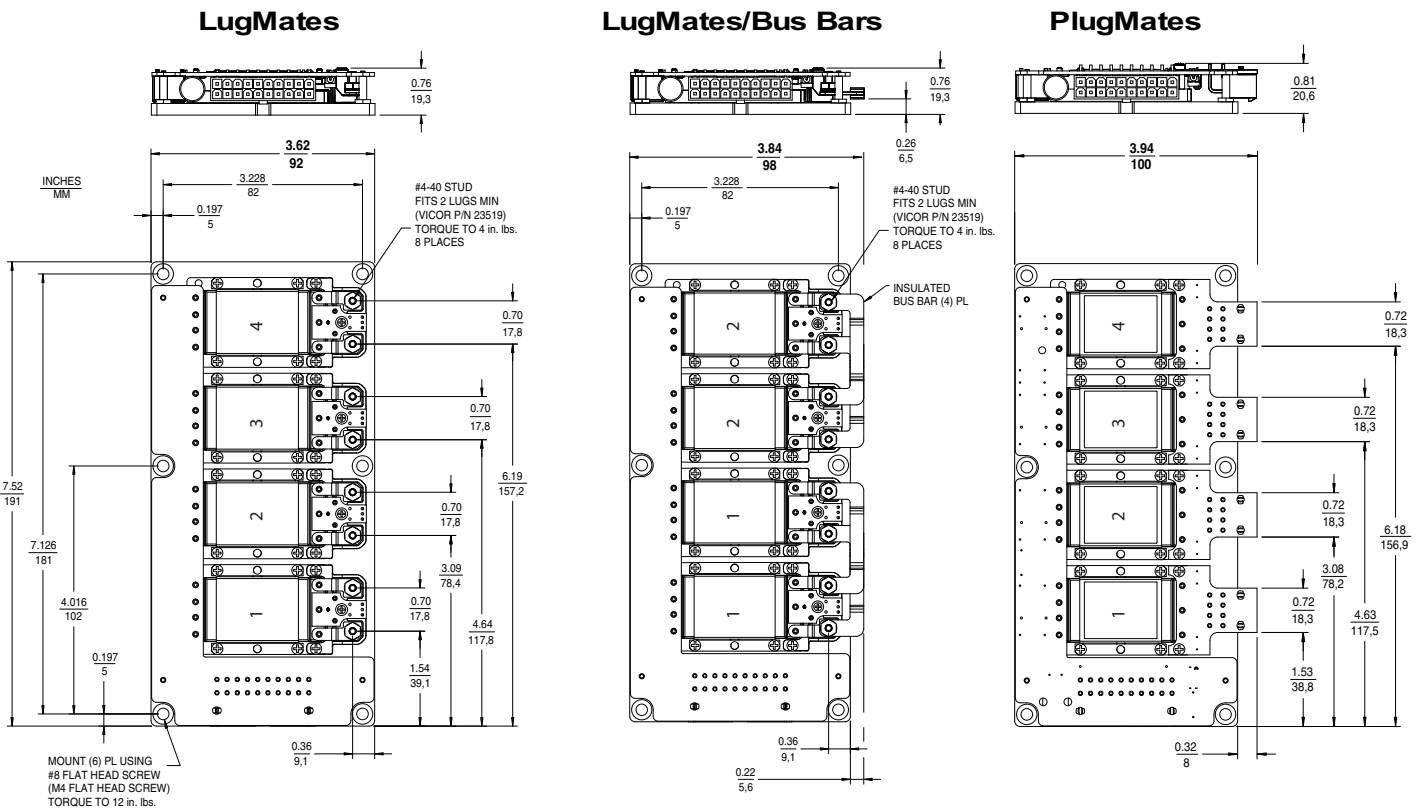

Not Recommended for New Designs

MECHANICAL DRAWINGS

Configuration G and K

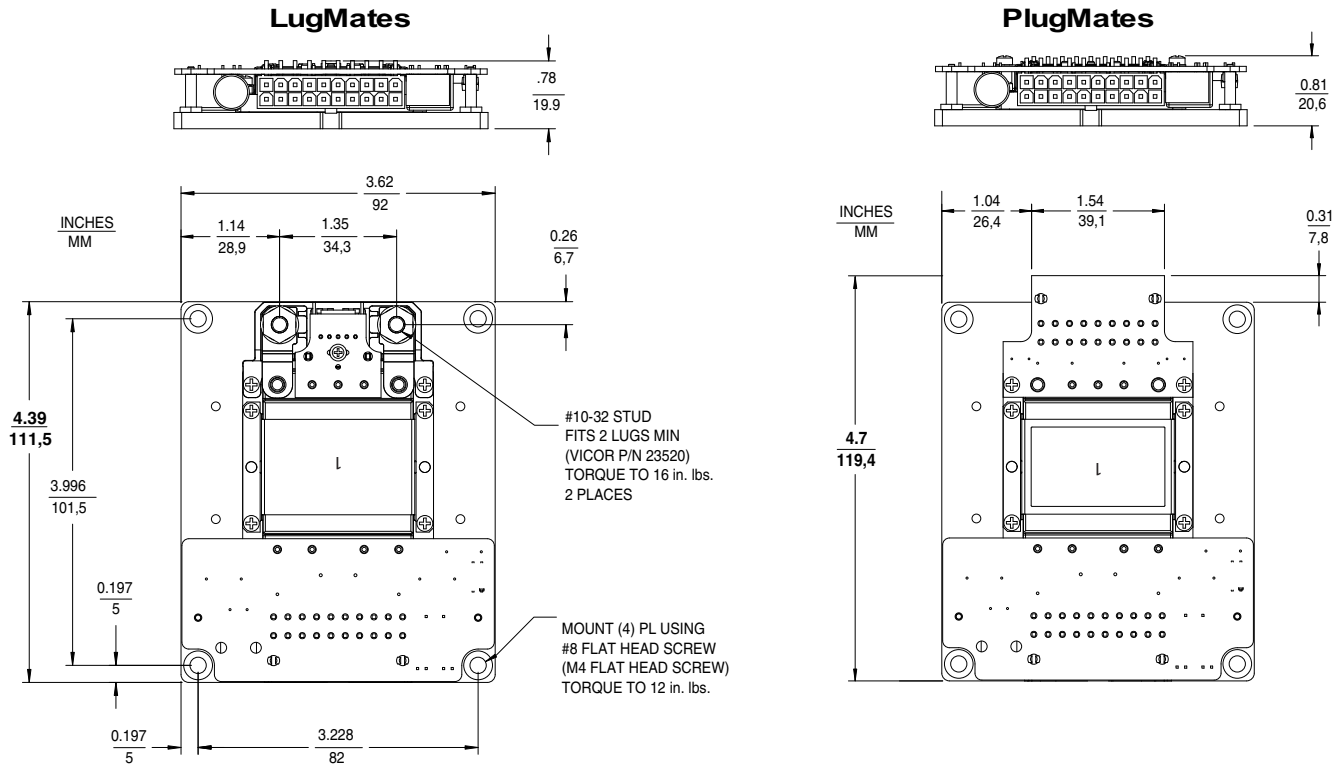

Configuration H

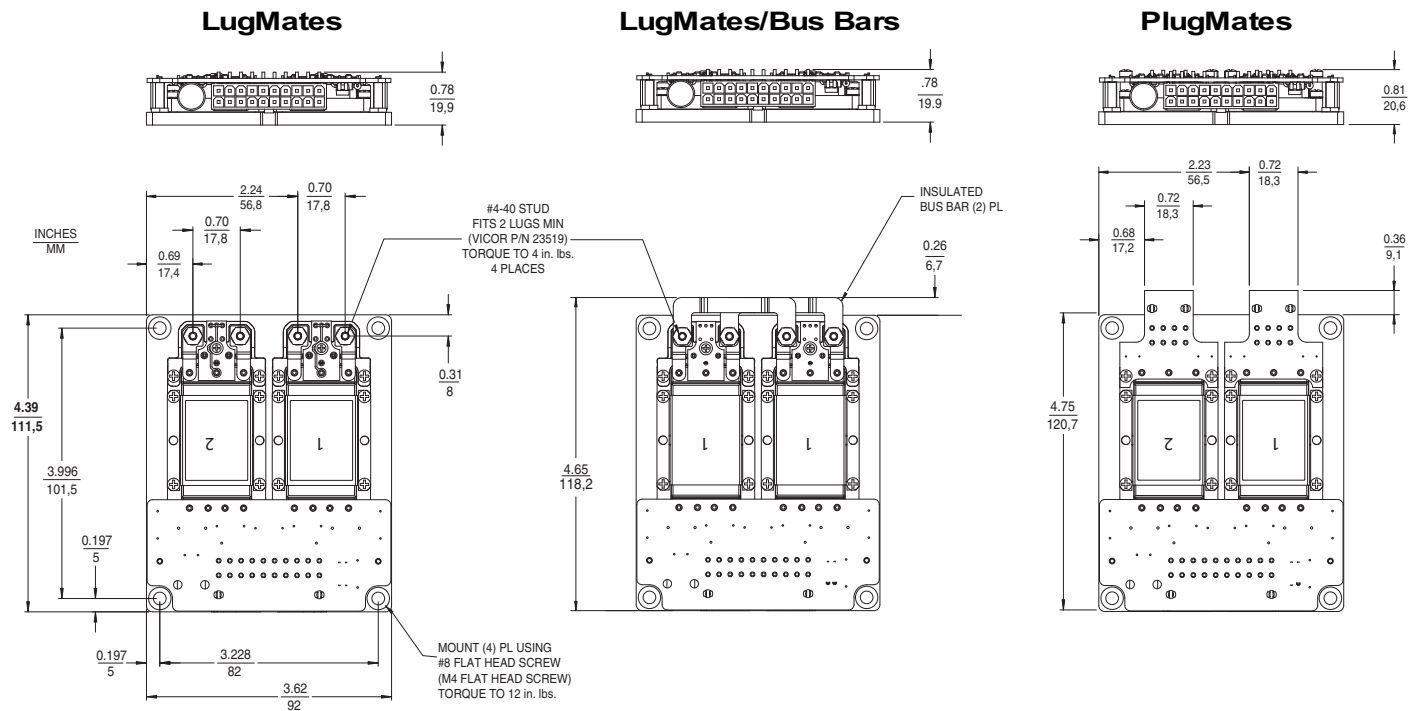

TECHNICAL SUPPORT CONTACTS

Vicor's Technical support team is staffed with Applications Engineers to provide the product and application information and technical assistance customers need concerning Vicor products and power solutions.

Our facilities house electronics laboratories where Vicor Applications Engineers can evaluate specific customer design issues and offer a wide range of component-based power solutions that include distributed power, current sharing, N + 1 redundancy, thermal management, and compliance with safety and performance standards.

Applications engineers ...

- Answer technical questions (by phone, fax, email, or the Vicor website).
- Assist with component-based power system design.
- Support user needs through visits to Vicor and customer facilities.
- Help select the most appropriate product for your application.

If you have a specific technical question, call or email an Applications Engineer located at one of our global offices.

USA

vicorpower.com

Vicor Corporation

(Corporate Headquarters)
25 Frontage Road
Andover, MA 01810-5413

For General Information

Tel: 978 470 2900
Fax: 978 475 6715

For Technical Support

Tel: 800 927 9474
Fax: 978 749 3341
email: apps@vicorpower.com

For Sales Support

U.S. and Canada: 800 735 6200
Fax: 978 475 6715
email: vicorexp@vicorpower.com

Europe

vicoreurope.com

Vicor France

Tel: +33 1 34 52 18 30
0800 419 419 (in France)
Fax: +33 1 34 52 28 30
email: vicorfr@vicorpower.com

Vicor Germany

Tel: +49 89 962 439 0
0800 018 29 18 (in Germany)
Fax: +49 89 962 439 39
email: expressde@vicorpower.com

Vicor Italy

Tel: +39 02 22 47 23 26
800 899 677 (in Italy)
Fax: +39 02 22 47 31 66
email: vicorit@vicorpower.com

Vicor U.K.

Tel: +44 1276 678222
UK: 0800 980 8427
Sweden: 020 794 143
Fax: +44 1276 681269
email: vicoruk@vicorpower.com

Asia-Pacific

Vicor Japan Co., Ltd.

Tokyo 141-0031 Japan
Tel: +81 3 5487 3880
Fax: +81 3 5487 3885
vicorpowerco.jp

Vicor Hong Kong

Tsim Sha Tsui, Hong Kong
vicor-asia.com
Tel: +852 2956 1782
Fax: +852 2956 0782

Latin America

Argentina: 800 555 4288
Brazil: 0800 8890 0288
Mexico: 011 52 333 647 7881

Ask the operator to connect you to: 800 735 6200

Not Reommended for New Designs

*Information furnished by Vicor is believed to be accurate and reliable. However, no responsibility is assumed by Vicor for its use. No license is granted by implication or otherwise under any patent or patent rights of Vicor. Vicor components are not designed to be used in applications, such as life support systems, wherein a failure or malfunction could result in injury or death. All sales are subject to Vicor's Terms and Conditions of Sale, which are available upon request. No user serviceable components, contact Vicor to arrange for repair or replacement. **Specifications are subject to change without notice.***

vicorpower.com



Vicor Corporation

Tel: 978-470-2900 Fax: 978-475-6715

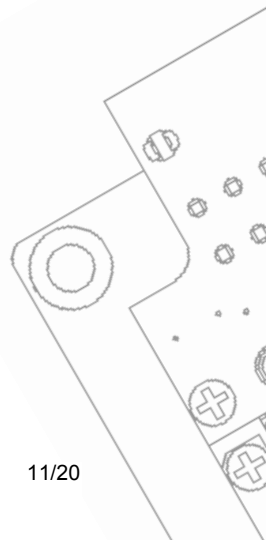

Mouser Electronics

Authorized Distributor

Click to View Pricing, Inventory, Delivery & Lifecycle Information:

Vicor:

[VA-D1139247](#) [VA-A2104827](#) [VA-A2108211](#) [VA-J2378867E](#) [VA-H2335744E](#) [VA-H2400816E](#) [VA-J3187820](#) [VA-J3208811E](#) [VA-J3211210E](#) [VA-J3224010](#) [VA-J3225438](#) [VA-K2500021](#) [VA-F2550416E](#) [VA-F2552426](#) [VA-F2578067E](#) [VA-F2827619E](#) [VA-F2841088](#) [VA-F2976027E](#) [VA-F2993024](#) [VA-F3016013](#) [VA-F3037885](#) [VA-F3101015](#) [VA-E2983445E](#) [VA-F3199812](#) [VA-F3210213E](#) [VA-F3216011](#) [VA-F3216410E](#) [VA-F3219644](#) [VA-G1124685](#) [VA-F2893627](#) [VA-F2914829E](#) [VA-F2916839](#) [VA-F2923015E](#) [VA-G1458186](#) [VA-F2625638E](#) [VA-G2197303](#) [VA-G2217034](#) [VA-G2279643](#) [VA-G2399144E](#) [VA-G2423674](#) [VA-F1974580](#) [VA-G1576584](#) [VA-G1599620](#) [VA-G1599635](#) [VA-G1659987](#) [VA-G2824461](#) [VA-F3104456E](#) [VA-F3125615E](#) [VA-F3144023](#) [VA-F3175232](#) [VA-F3176221](#) [VA-F3176615](#) [VA-G3094220](#) [VA-G3133449E](#) [VA-G3179250E](#) [VA-G3206225](#) [VA-H1098317](#) [VA-H1431208](#) [VA-H1433133](#) [VA-G2349846E](#) [VA-G2642018](#) [VA-G2666244](#) [VA-G2718831E](#) [VA-G2779832E](#) [VA-D2046981](#) [VA-D2361065E](#) [VA-D2363437](#) [VA-D2370638](#) [VA-D3190666E](#) [VA-D3199436E](#) [VA-D3203817E](#) [VA-D3203821E](#) [VA-D3204819E](#) [VA-D3206019E](#) [VA-D3215816](#) [VA-D3215825](#) [VA-D3233493E](#) [VA-D2664222](#) [VA-D2666267](#) [VA-D2676413](#) [VA-D2685611](#) [VA-D2512823E](#) [VA-E2179016](#) [VA-E2188076](#) [VA-D1236788](#) [VA-E2595667](#) [VA-E2622878](#) [VA-E2653019](#) [VA-E2655087](#) [VA-E2667023](#) [VA-E2675446](#) [VA-D3017811](#) [VA-D3089411E](#) [VA-D3089430](#) [VA-D3093067E](#) [VA-D3094212](#) [VA-D3099000E](#) [VA-E3158619](#) [VA-E3158628](#) [VA-E3163641](#)