

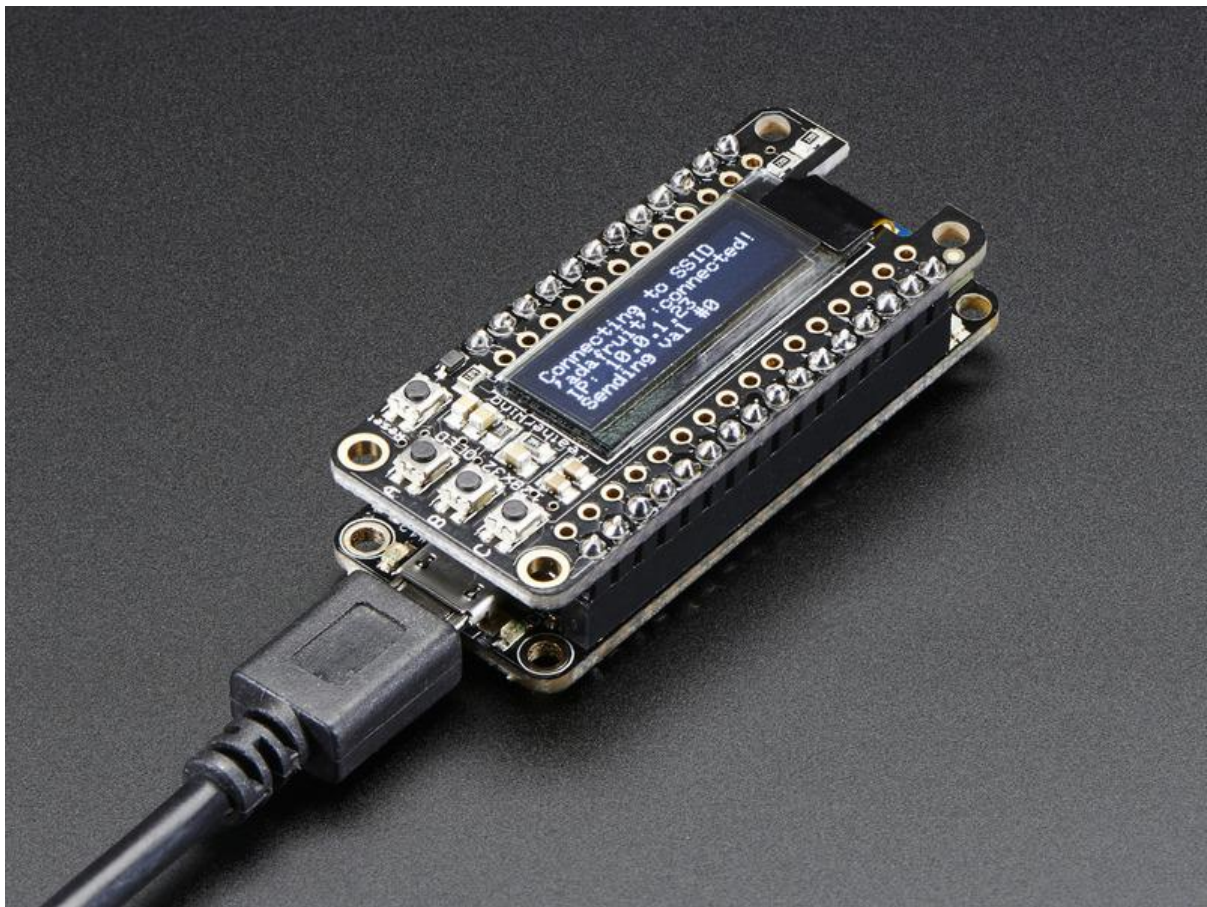

Adafruit Feather M0 WiFi with ATWINC1500

Created by lady ada



<https://learn.adafruit.com/adafruit-feather-m0-wifi-atwinc1500>

Last updated on 2021-11-15 06:38:02 PM EST

Table of Contents

Overview	5
Pinouts	9
• Power Pins	10
• Logic pins	11
• WiFi Module & LEDs	12
• Other Pins!	12
Assembly	13
• Header Options!	13
• Soldering in Plain Headers	16
• Prepare the header strip:	16
• Add the breakout board:	17
• And Solder!	17
• Soldering on Female Header	19
• Tape In Place	19
• Flip & Tack Solder	20
• And Solder!	21
Power Management	22
• Battery + USB Power	23
• Power supplies	24
• Measuring Battery	24
• ENable pin	25
• Alternative Power Options	25
• Power Usage & Saving with WiFi	26
Arduino IDE Setup	28
Using with Arduino IDE	31
• Install SAMD Support	31
• Install Adafruit SAMD	32
• Install Drivers (Windows 7 & 8 Only)	33
• Blink	35
• Successful Upload	36
• Compilation Issues	37
• Manually bootloading	38
• Ubuntu & Linux Issue Fix	38
Using the WiFi Module	39
• Install the Library	39
• Check Connections & Version	40
• Scanning WiFi	42
• Connect & Read Webpage	43
• Creating an Access Point + Webserver	44
Updating Firmware	47
Updating SSL Certificates	51

Adapting Sketches to M0 & M4	56
<hr/>	
• Analog References	56
• Pin Outputs & Pullups	56
• Serial vs SerialUSB	56
• AnalogWrite / PWM on Feather/Metro M0	57
• analogWrite() PWM range	58
• analogWrite() DAC on A0	59
• Missing header files	59
• Bootloader Launching	59
• Aligned Memory Access	60
• Floating Point Conversion	60
• How Much RAM Available?	61
• Storing data in FLASH	61
• Pretty-Printing out registers	61
• M4 Performance Options	62
• CPU Speed (overclocking)	62
• Optimize	63
• Cache	63
• Max SPI and Max QSPI	63
• Enabling the Buck Converter on some M4 Boards	64
Downloads	64
<hr/>	
• Datasheets & Files	64
• Schematic	65
• Fabrication Print	65
Feather HELP!	65
<hr/>	

Overview

Feather is the new development board from Adafruit, and like its namesake it is thin, light, and lets you fly! We designed Feather to be a new standard for portable microcontroller cores.

This is the Adafruit Feather M0 WiFi w/ATWINC1500 - our take on an 'all-in-one' Arduino-compatible + high speed, reliable WiFi with built in USB and battery charging. Its an Adafruit Feather M0 [with a WiFi module \(http://adafru.it/2999\)](http://adafru.it/2999), ready to rock! [We have other boards in the Feather family, check'em out here \(https://adafru.it/17B\)](https://adafru.it/17B).

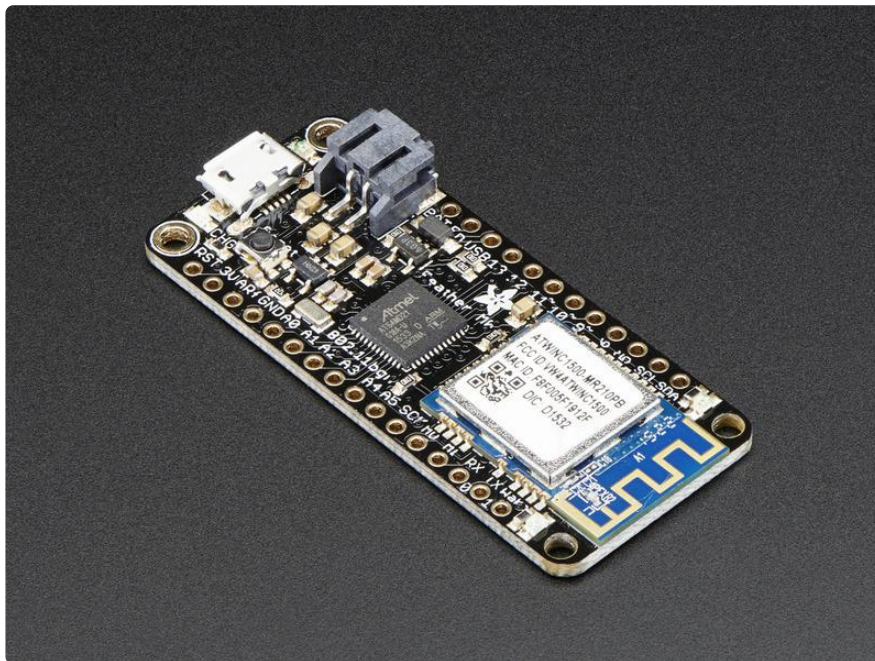

Connect your Feather to the Internet with this fine new FCC-certified WiFi module from Atmel. This 802.11bgn-capable WiFi module is the best new thing for networking your devices, with built-in low-power management capabilities, Soft-AP, SSL support and rock solid performance. We were running our adafruit.io MQTT demo for a full weekend straight with no hiccups (it would have run longer but we had to go to work, so we unplugged it). This module is very fast & easy to use in comparison to other WiFi modules we've used in the past.

This module works with 802.11b, g, or n networks & supports WEP, WPA and WPA2 encryption. You can connect to your own WiFi networks or create your own with "Soft AP" mode, where it becomes its own access point (we have an example of it creating a webserver that you can then control the Arduino's pins). You can clock it as fast as 12MHz for speedy, reliable packet streaming. And scanning/connecting to networks is very fast, just a second or two.

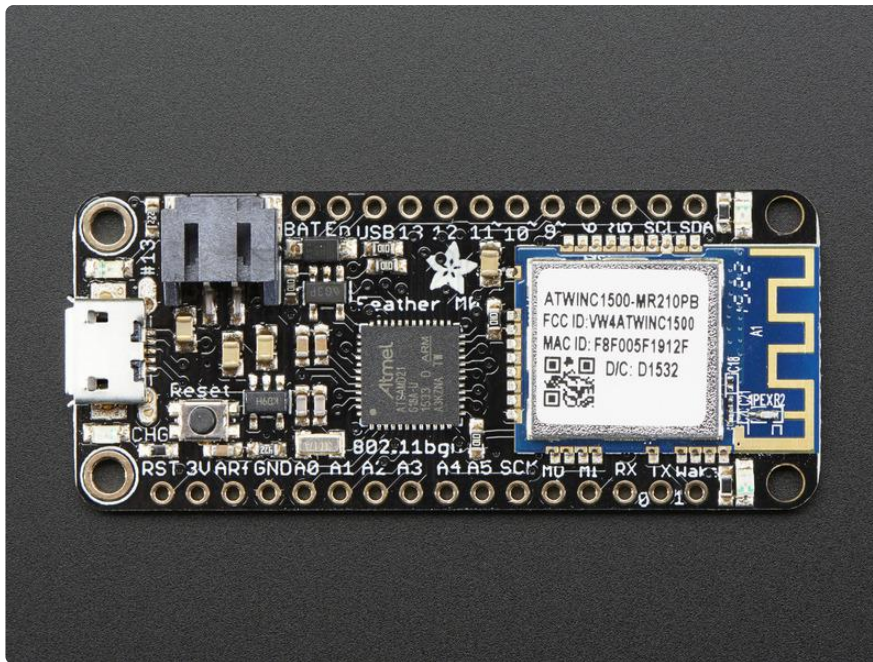

At the Feather M0's heart is an ATSAM21G18 ARM Cortex M0 processor,

battery, it will run just fine straight from the micro USB connector. But, if you do have a battery, you can take it on the go, then plug in the USB to recharge. The Feather will automatically switch over to USB power when its available. We also tied the battery through a divider to an analog pin, so you can measure and monitor the battery voltage to detect when you need a recharge.

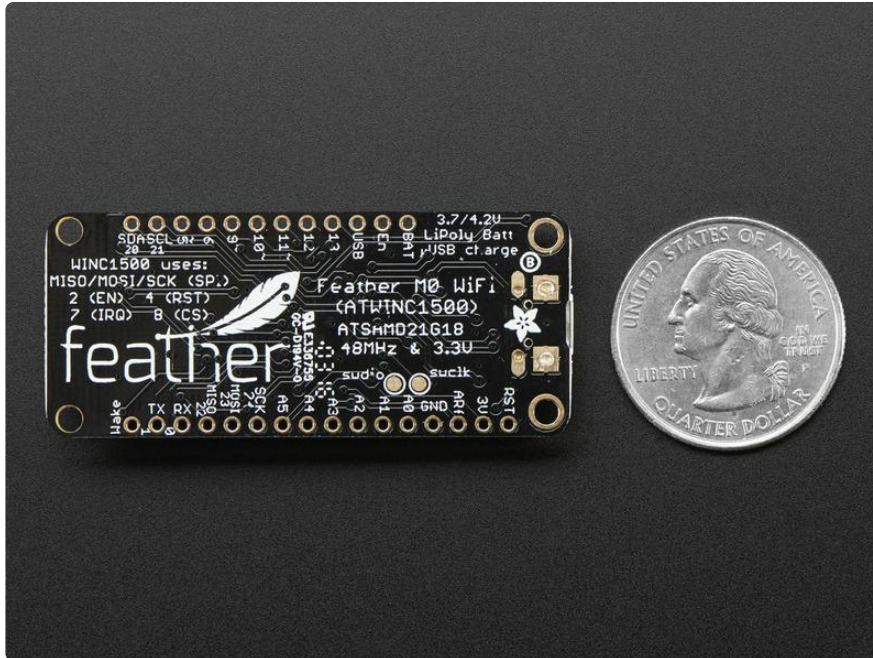

Here's some handy specs! Like all Feather M0's you get:

- Measures 2.1" x 0.9" x 0.3" (53.65mm x 23mm x 8mm) without headers soldered in. Note it is 0.1" longer than most Feathers
- Light as a (large?) feather - 6.1 grams
- ATSAM21G18 @ 48MHz with 3.3V logic/power
- 256KB FLASH, 32KB SRAM, No EEPROM
- 3.3V regulator (AP2112K-3.3) with 600mA peak current output, WiFi can draw 300mA peak during xmit
- USB native support, comes with USB bootloader and serial port debugging
- You also get tons of pins - 20 GPIO pins
- Hardware Serial, hardware I2C, hardware SPI support
- 8 x PWM pins
- 10 x analog inputs
- 1 x analog output
- Built in 200mA lipoly charger with charging status indicator LED
- Pin #13 red LED for general purpose blinking
- Power/enable pin
- 4 mounting holes
- Reset button

The Feather M0 Adalogger is chock-full of microcontroller goodness. There's also a lot of pins and ports. We'll take you a tour of them now!

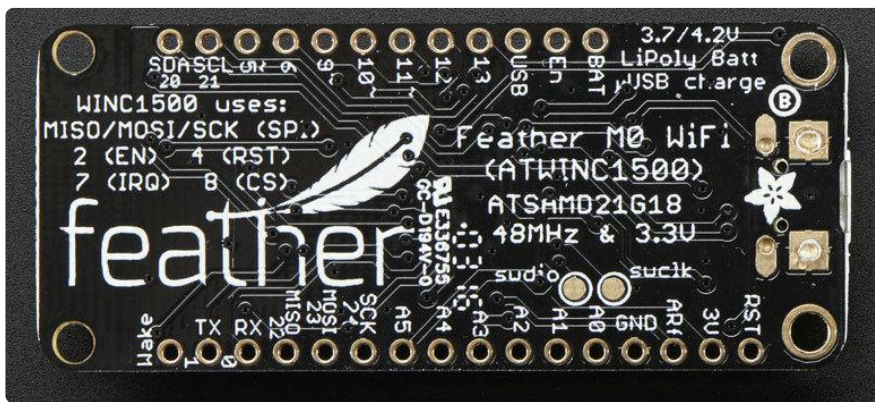
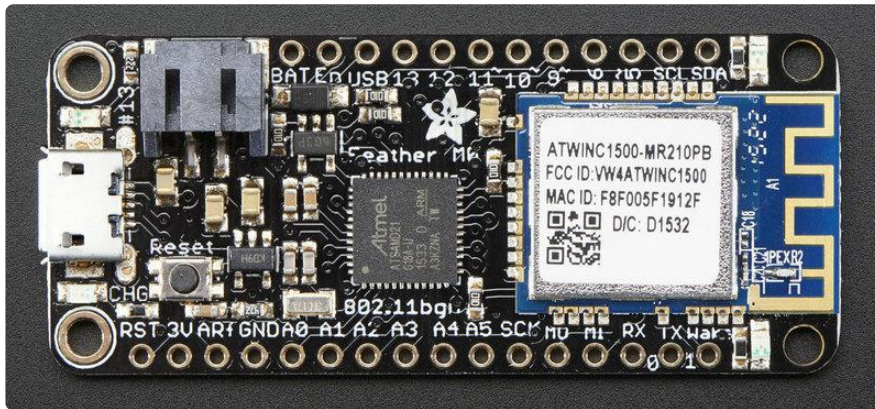

Power Pins

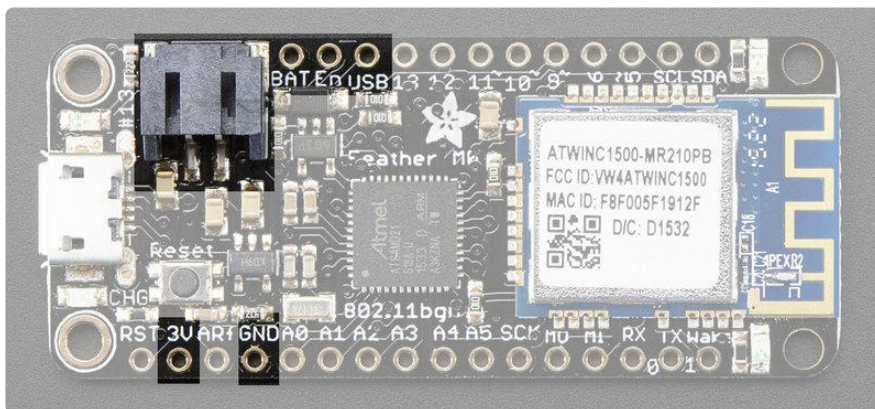

- GND - this is the common ground for all power and logic
- BAT - this is the positive voltage to/from the JST jack for the optional Lipoly battery
- USB - this is the positive voltage to/from the micro USB jack if connected
- EN - this is the 3.3V regulator's enable pin. It's pulled up, so connect to ground to disable the 3.3V regulator

- 3V - this is the output from the 3.3V regulator, it can supply 600mA peak

Logic pins

This is the general purpose I/O pin set for the microcontroller.

All logic is 3.3V

Nearly all pins can do PWM output

All pins can be interrupt inputs

- #0 / RX - GPIO #0, also receive (input) pin for Serial1 (hardware UART), also can be analog input
- #1 / TX - GPIO #1, also transmit (output) pin for Serial1, also can be analog input
- #20 / SDA - GPIO #20, also the I2C (Wire) data pin. There's no pull up on this pin by default so when using with I2C, you may need a 2.2K-10K pullup.
- #21 / SCL - GPIO #21, also the I2C (Wire) clock pin. There's no pull up on this pin by default so when using with I2C, you may need a 2.2K-10K pullup.
- #5 - GPIO #5
- #6 - GPIO #6
- #9 - GPIO #9, also analog input A7. This analog input is connected to a voltage divider for the lipoly battery so be aware that this pin naturally 'sits' at around 2VDC due to the resistor divider
- #10 - GPIO #10
- #11 - GPIO #11
- #12 - GPIO #12
- #13 - GPIO #13 and is connected to the red LED next to the USB jack
- A0 - This pin is analog input A0 but is also an analog output due to having a DAC (digital-to-analog converter). You can set the raw voltage to anything from 0 to 3.3V, unlike PWM outputs this is a true analog output
- A1 thru A5 - These are each analog input as well as digital I/O pins.
- SCK/MOSI/MISO (GPIO 24/23/22)- These are the hardware SPI pins, you can use them as everyday GPIO pins (but recommend keeping them free as they are best used for hardware SPI connections for high speed)

WiFi Module & LEDs



Since not all pins can be brought out to breakouts, due to the small size of the Feather, we use these to control the WiFi module

- #2 - used as the ENable pin for the WiFi module, by default pulled down low, set HIGH to enable WiFi
- #4 - used as the Reset pin for the WiFi module, controlled by the library
- #7 - used as the IRQ interrupt request pin for the WiFi module, controlled by the library
- #8 - used as the Chip Select pin for the WiFi module, used to select it for SPI data transfer
- MOSI / MISO / SCK - the SPI pins are also used for WiFi module communication
- Green LED - the top LED, in green, will light when the module has connected to an SSID
- Yellow LED - the bottom LED, in yellow, will blink during data transfer

Other Pins!

- RST - this is the Reset pin, tie to ground to manually reset the AVR, as well as launch the bootloader manually
- ARef - the analog reference pin. Normally the reference voltage is the same as the chip logic voltage (3.3V) but if you need an alternative analog reference, connect it to this pin and select the external AREF in your firmware. Can't go higher than 3.3V!
- Wake - connected to the Wake pin on the WiFi module, not used at this time but it's there if you want it

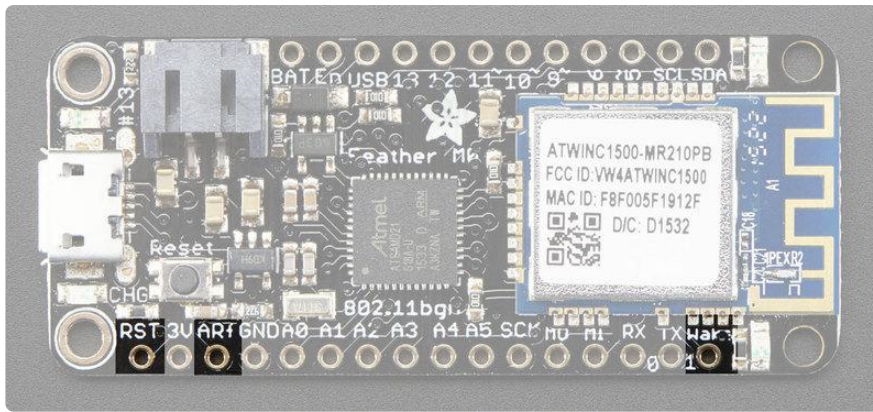

SWCLK & SWDIO - These pads on the bottom are used to program the chip. They can also be connected to an SWD debugger.

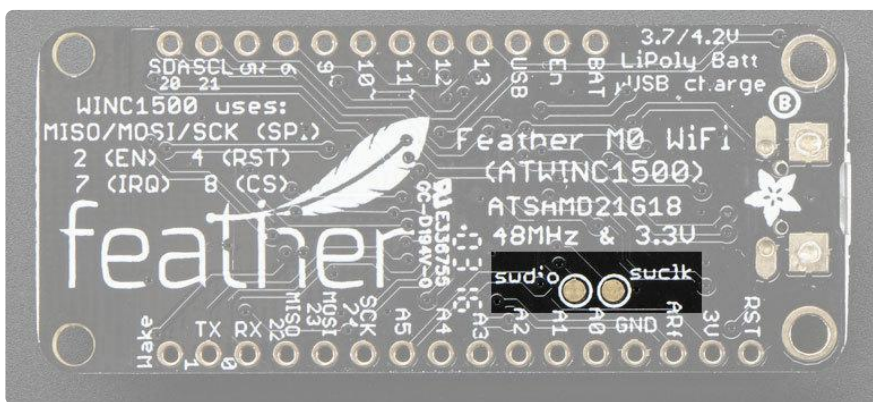

Assembly

We ship Feathers fully tested but without headers attached - this gives you the most flexibility on choosing how to use and configure your Feather

Header Options!

Before you go gung-ho on soldering, there's a few options to consider!

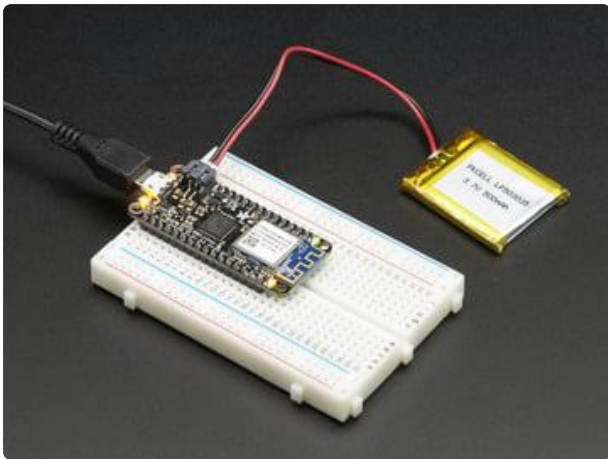

The first option is soldering in plain male headers, this lets you plug in the Feather into a solderless breadboard

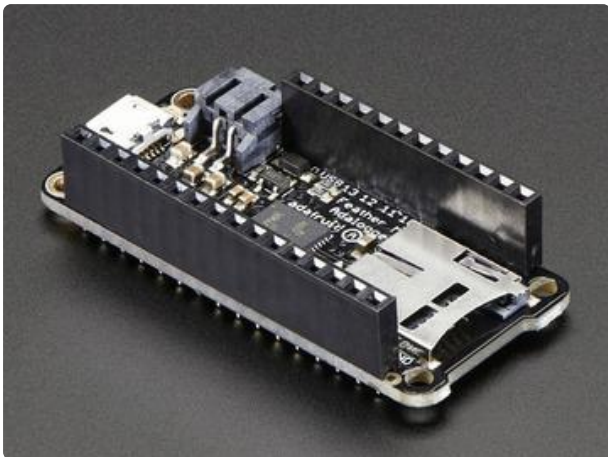
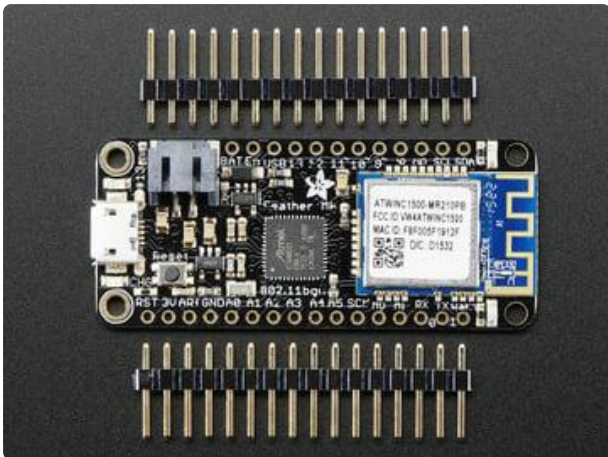

Another option is to go with socket female headers. This won't let you plug the Feather into a breadboard but it will let you attach featherwings very easily

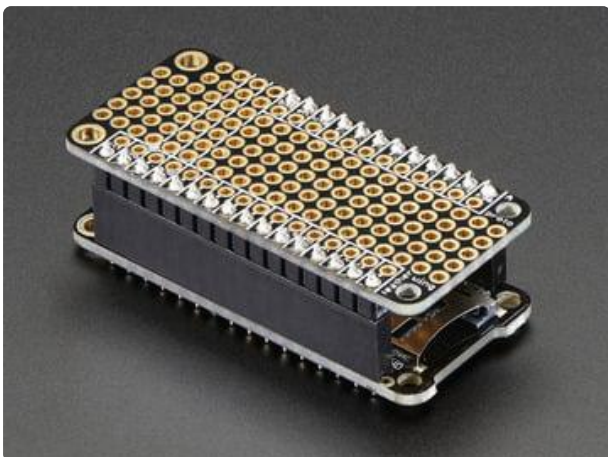

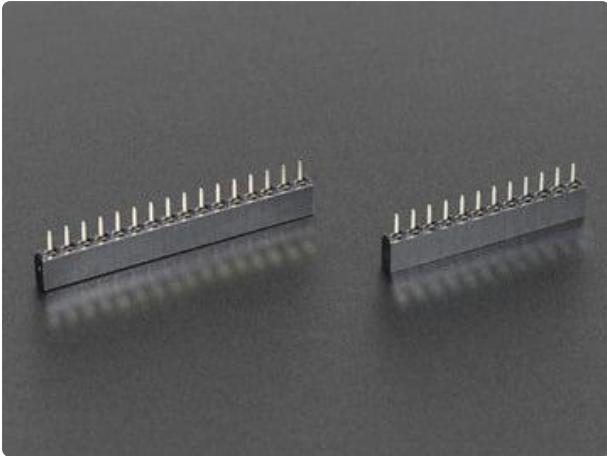

We also have 'slim' versions of the female headers, that are a little shorter and give a more compact shape

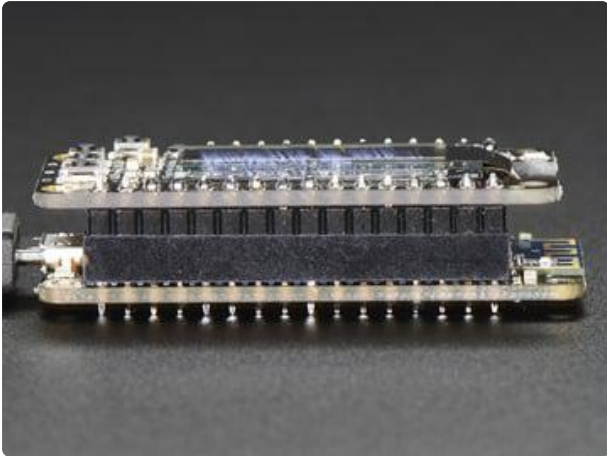

Finally, there's the "Stacking Header" option. This one is sort of the best-of-both-worlds. You get the ability to plug into a solderless breadboard and plug a featherwing on top. But its a little bulky

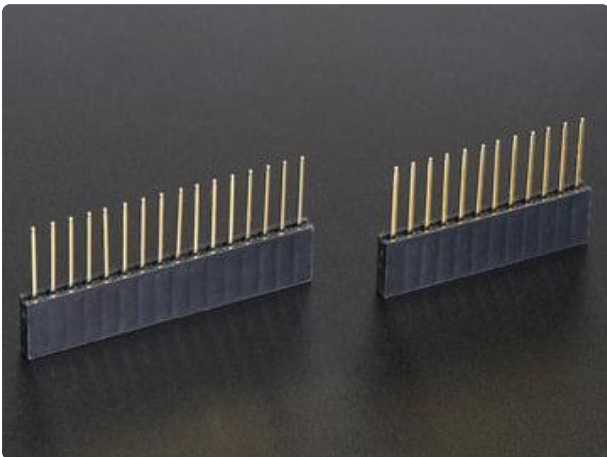

Soldering in Plain Headers

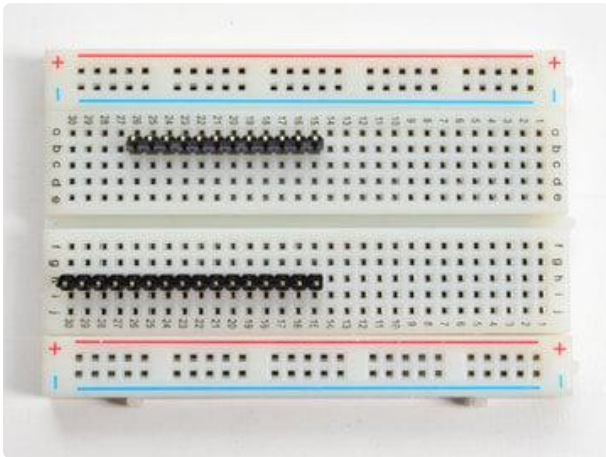

Prepare the header strip:
Cut the strip to length if necessary. It will be easier to solder if you insert it into a breadboard - long pins down

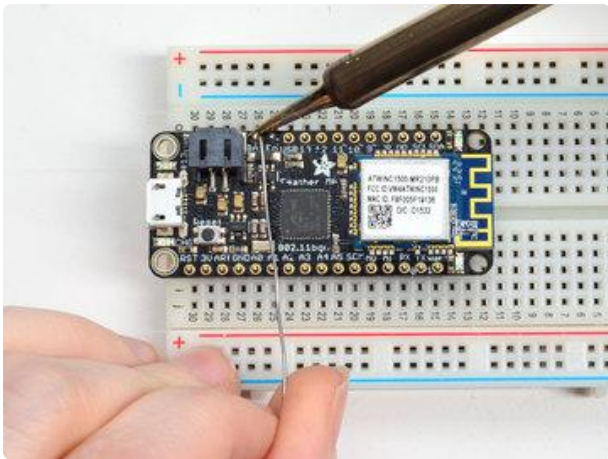

Add the breakout board:

Place the breakout board over the pins so that the short pins poke through the breakout pads

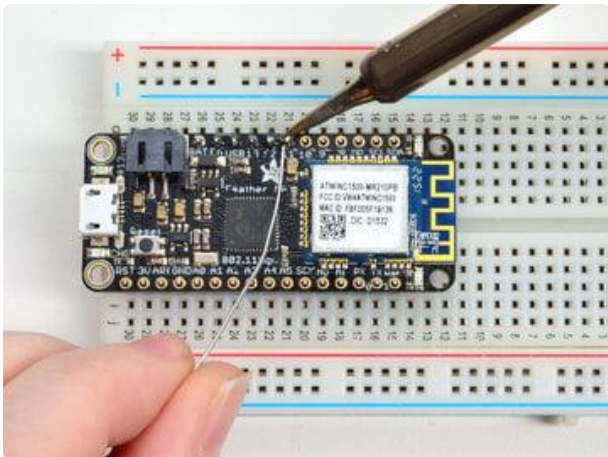

And Solder!

Be sure to solder all pins for reliable electrical contact.

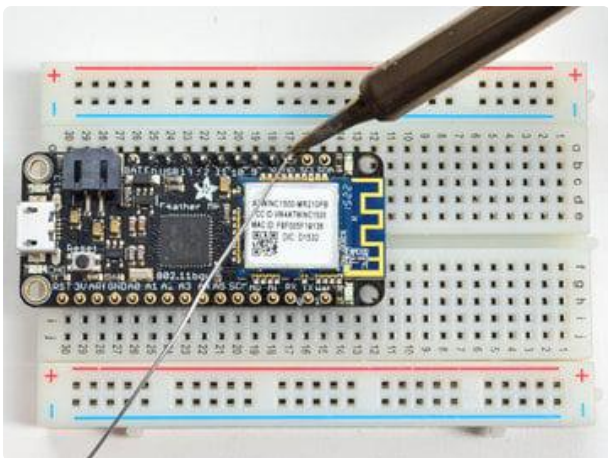

(For tips on soldering, be sure to check out our [Guide to Excellent Soldering](https://adafru.it/aTk) (<https://adafru.it/aTk>)).

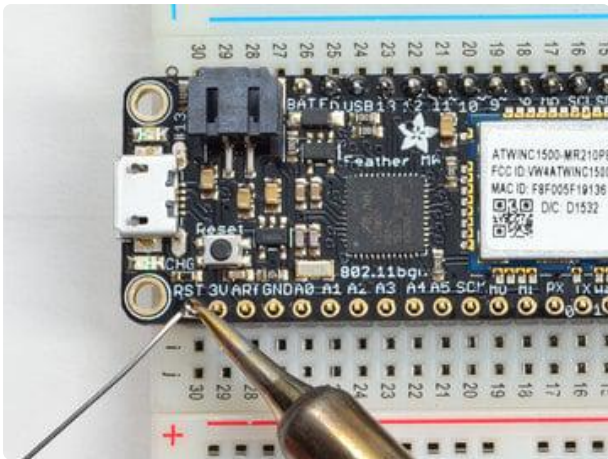

Solder the other strip as well.

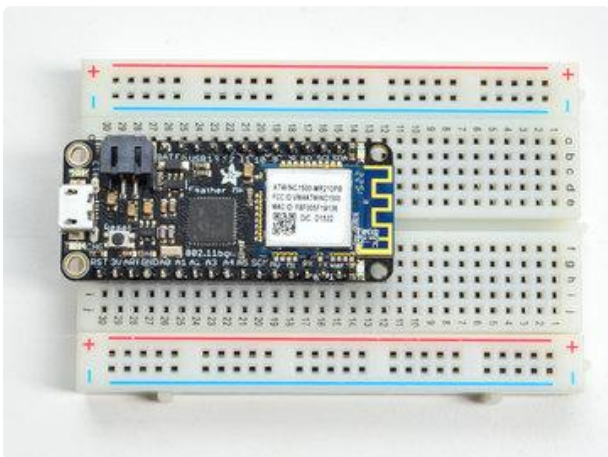
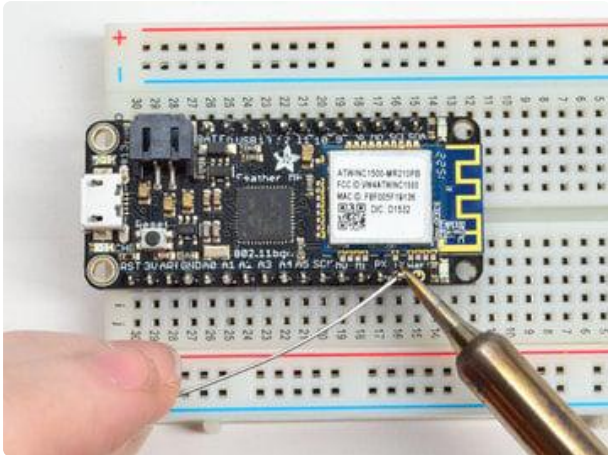
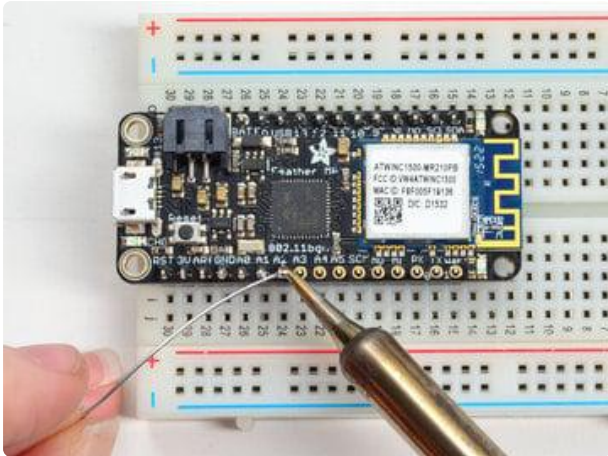

You're done! Check your solder joints visually and continue onto the next steps

Soldering on Female Header



Tape In Place

For sockets you'll want to tape them in place so when you flip over the board they don't fall out

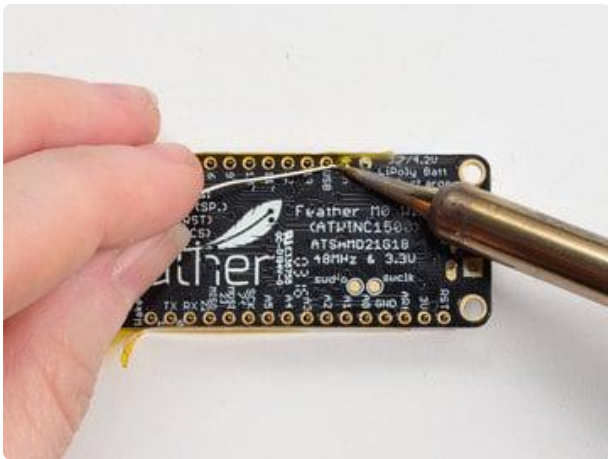

Flip & Tack Solder

After flipping over, solder one or two points on each strip, to 'tack' the header in place

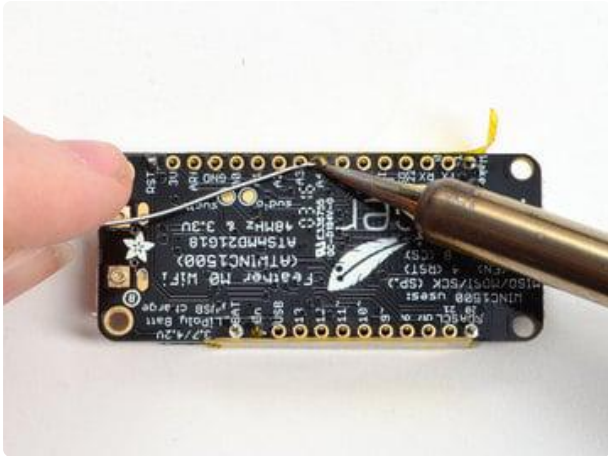

And Solder!

Be sure to solder all pins for reliable electrical contact.

(For tips on soldering, be sure to check out our [Guide to Excellent Soldering \(https://adafru.it/aTk\)](https://adafru.it/aTk)).

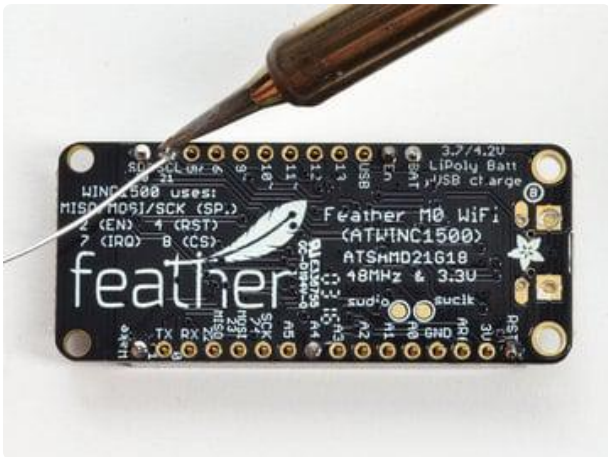



You're done! Check your solder joints visually and continue onto the next steps



Power Management

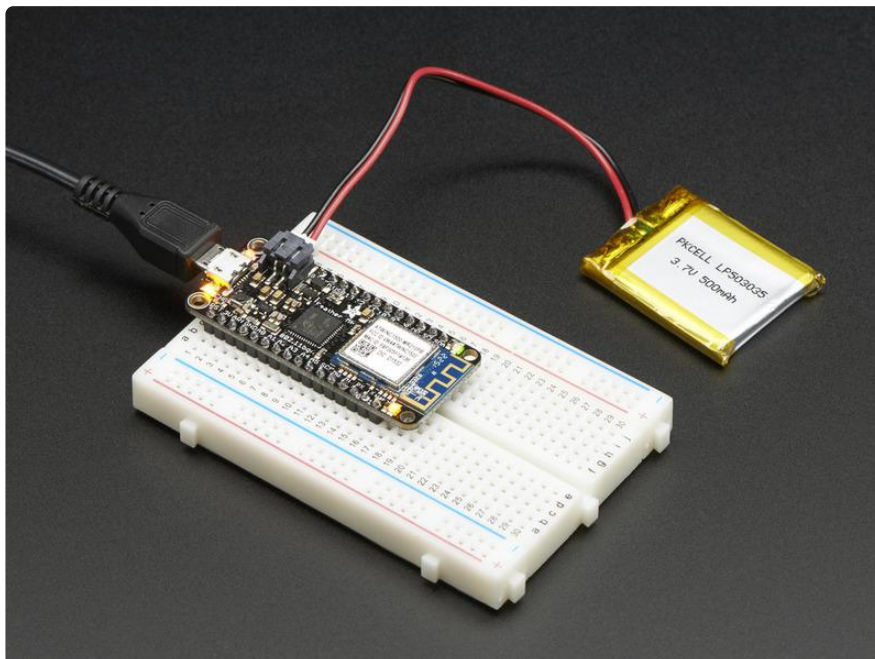

Battery + USB Power

We wanted to make the Feather easy to power both when connected to a computer as well as via battery. There's two ways to power a Feather. You can connect with a MicroUSB cable (just plug into the jack) and the Feather will regulate the 5V USB down to 3.3V. You can also connect a 4.2/3.7V Lithium Polymer (Lipo/Lipoly) or Lithium Ion (Lilon) battery to the JST jack. This will let the Feather run on a rechargeable battery. When the USB power is powered, it will automatically switch over to USB for power, as well as start charging the battery (if attached) at 200mA. This happens 'hotswap' style so you can always keep the Lipoly connected as a 'backup' power that will only get used when USB power is lost.

The JST connector polarity is matched to Adafruit LiPoly batteries. Using wrong polarity batteries can destroy your Feather

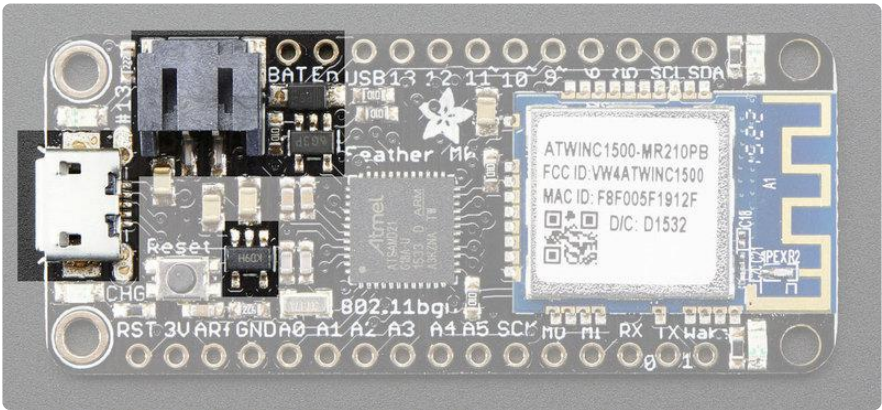

The above shows the Micro USB jack (left), Lipoly JST jack (top left), as well as the 3.3V regulator and changeover diode (just to the right of the JST jack) and the Lipoly charging circuitry (to the right of the Reset button). There's also a CHG LED, which will light up while the battery is charging. This LED might also flicker if the battery is not connected.

The charge LED is automatically driven by the Lipoly charger circuit. It will try to detect a battery and is expecting one to be attached. If there isn't one it may flicker once in a while when you use power because it's trying to charge a (non-existent) battery. It's not harmful, and it's totally normal!

Power supplies

You have a lot of power supply options here! We bring out the BAT pin, which is tied to the lipoly JST connector, as well as USB which is the +5V from USB if connected. We also have the 3V pin which has the output from the 3.3V regulator. We use a 600mA peak AP2112K-33. While you can get 600mA from it, you can't do it continuously from 5V as it will overheat the regulator. It's fine for, say, powering the attached WiFi chip or XBee radio though, since the current draw is 'spiky' & sporadic.

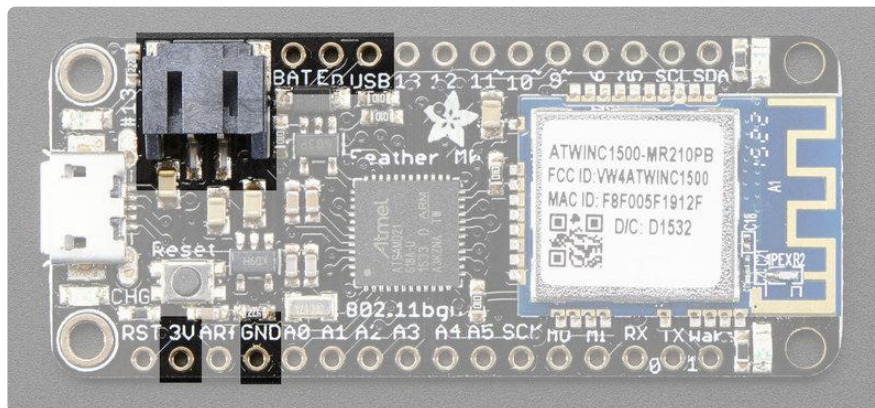

Measuring Battery

If you're running off of a battery, chances are you wanna know what the voltage is at! That way you can tell when the battery needs recharging. Lipoly batteries are 'maxed out' at 4.2V and stick around 3.7V for much of the battery life, then slowly sink down to 3.2V or so before the protection circuitry cuts it off. By measuring the voltage you can quickly tell when you're heading below 3.7V

To make this easy we stuck a double-100K resistor divider on the BAT pin, and connected it to D9 (a.k.a analog #7 A7). You can read this pin's voltage, then double it, to get the battery voltage.

```
#define VBATPIN A7

float measuredvbat = analogRead(VBATPIN);
measuredvbat *= 2; // we divided by 2, so multiply back
measuredvbat *= 3.3; // Multiply by 3.3V, our reference voltage
measuredvbat /= 1024; // convert to voltage
Serial.print("VBat: " ); Serial.println(measuredvbat);
```

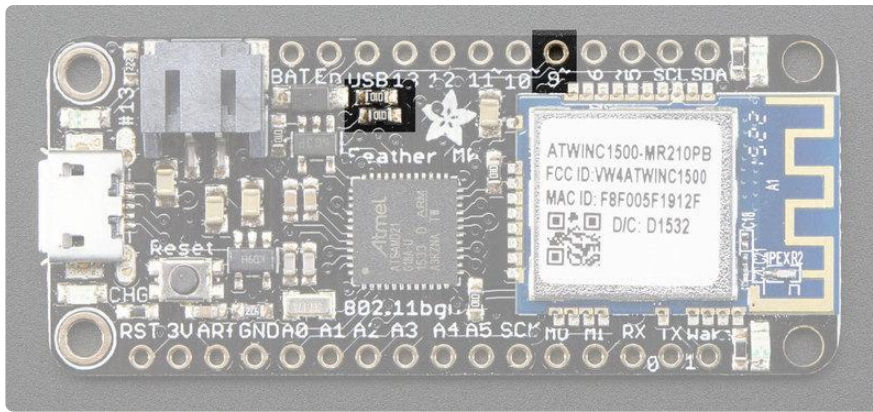
ENable pin

If you'd like to turn off the 3.3V regulator, you can do that with the EN(able) pin. Simply tie this pin to Ground and it will disable the 3V regulator. The BAT and USB pins will still be powered

Alternative Power Options

The two primary ways for powering a feather are a 3.7/4.2V LiPo battery plugged into the JST port or a USB power cable.

If you need other ways to power the Feather, here's what we recommend:

- For permanent installations, a [5V 1A USB wall adapter \(https://adafruit.it/duP\)](https://adafruit.it/duP) will let you plug in a USB cable for reliable power
- For mobile use, where you don't want a LiPoly, [use a USB battery pack! \(https://adafruit.it/e2q\)](https://adafruit.it/e2q)
- If you have a higher voltage power supply, [use a 5V buck converter \(https://adafruit.it/DHs\)](https://adafruit.it/DHs) and wire it to a [USB cable's 5V and GND input \(https://adafruit.it/DHu\)](https://adafruit.it/DHu)

Here's what you cannot do:

- Do not use alkaline or NiMH batteries and connect to the battery port - this will destroy the LiPoly charger and there's no way to disable the charger
- Do not use 7.4V RC batteries on the battery port - this will destroy the board

The Feather is not designed for external power supplies - this is a design decision to make the board compact and low cost. It is not recommended, but technically possible:

- Connect an external 3.3V power supply to the 3V and GND pins. Not recommended, this may cause unexpected behavior and the EN pin will no longer. Also this doesn't provide power on BAT or USB and some Feathers/Wings use those pins for high current usages. You may end up damaging your Feather.
- Connect an external 5V power supply to the USB and GND pins. Not recommended, this may cause unexpected behavior when plugging in the USB port because you will be back-powering the USB port, which could confuse or damage your computer.

Power Usage & Saving with WiFi

WiFi is a very power-hungry protocol. During transmit and SSID association, you'll see high power usages. For example, here is an MQTT demo running where it connects to the WPA SSID and then sends a packet every 5 seconds or so:

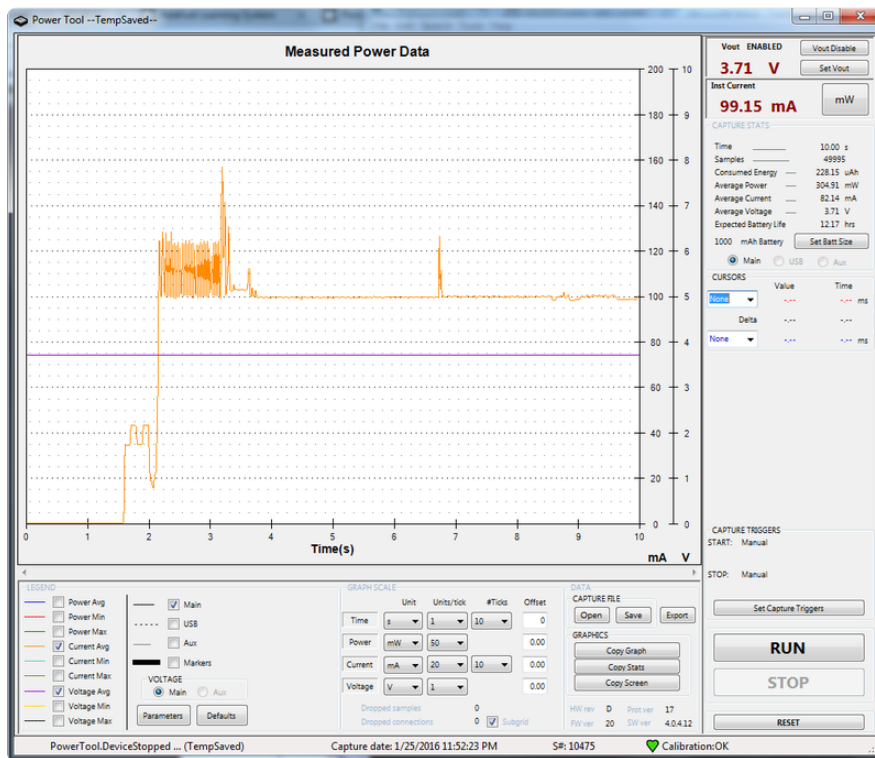

You can see the chip launch at about 1.5 seconds, then turn on the WiFi and at about 2s make the SSID connection and MQTT connection. The average current is about 100ms afterwards, and a packet spikes up to ~130mA at the 7 second mark.

100mA is still quite a bit, you can very easily reduce this by letting the WINC1500 manage its own power:

```
WiFi.setSleepMode(M2M_PS_H_AUTOMATIC, 1); // go into power save mode when possible!
```

When this line is added, it lets the WINC1500 know that when nothings going on, shut down unneeded parts. You dont have to manage the power modes, and the power will drop down nearly instantly to about 22mA average (there's still spikes during transmit of course)

If you're using the Arduino WiFi101 library, call this instead to enable automatic sleep:

```
WiFi.lowPowerMode();
```

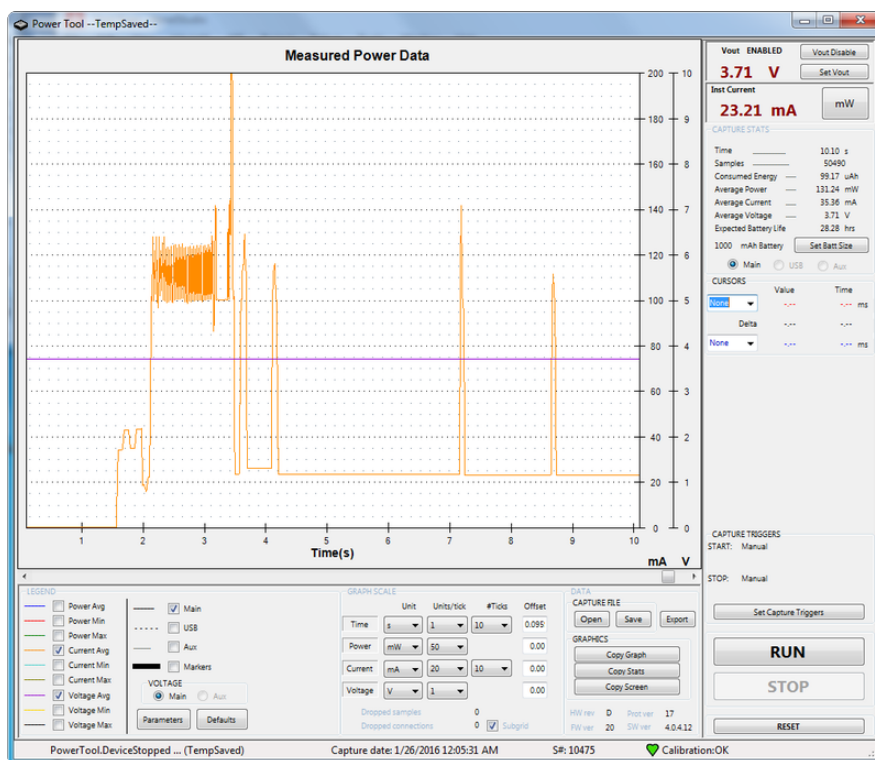

Note that 10mA or so is for the ATSAMd chip, so that means you've got ~12mA for the WiFi module.

If you want ultra-low power you can manage the WINC1500 module your own with

```
WiFi.setSleepMode(M2M_PS_MANUAL, 1);
```

And then when you want it to go to sleep call:

```
WiFi.requestSleep(sleeptimeinmilliseconds)
```

With this mode, you can get much much lower power when you call the `requestSleepmode` (basically 1-2mA) and still have an active live WiFi connection...but, when not actively sleeping the power usage seems higher (see that spikey part between seconds 3 and 8.5)

A mix of the two may give you the best performance. And don't forget that the SAMD21 is going to draw 10mA so put the main chip to sleep too if you want to get to very low power sleep modes!

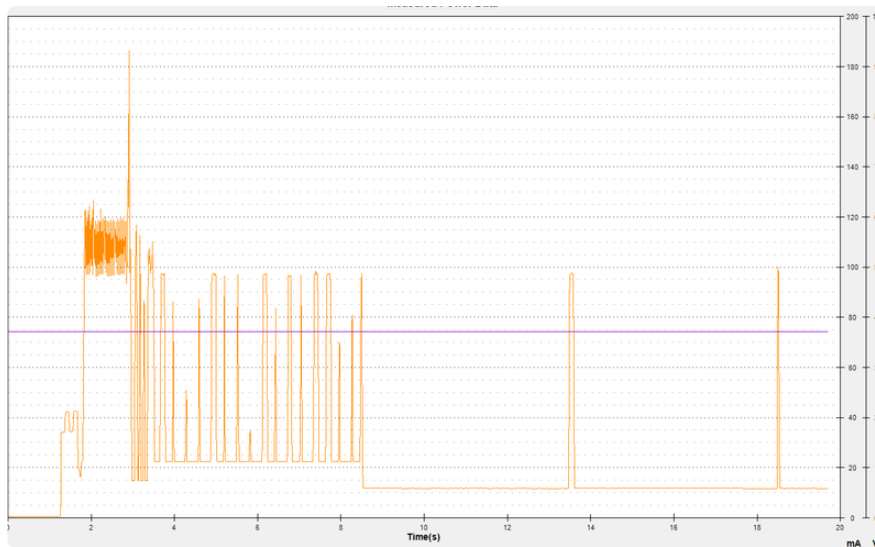

Arduino IDE Setup

The first thing you will need to do is to download the latest release of the Arduino IDE. You will need to be using version 1.8 or higher for this guide

Arduino IDE Download

<https://adafru.it/f1P>

After you have downloaded and installed the latest version of Arduino IDE, you will need to start the IDE and navigate to the Preferences menu. You can access it from the File menu in Windows or Linux, or the Arduino menu on OS X.

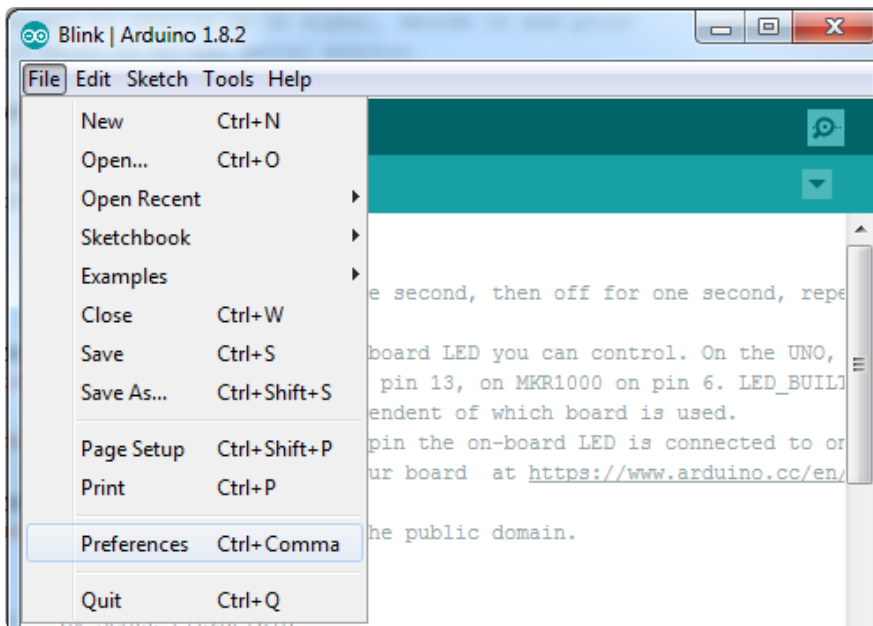

A dialog will pop up just like the one shown below.

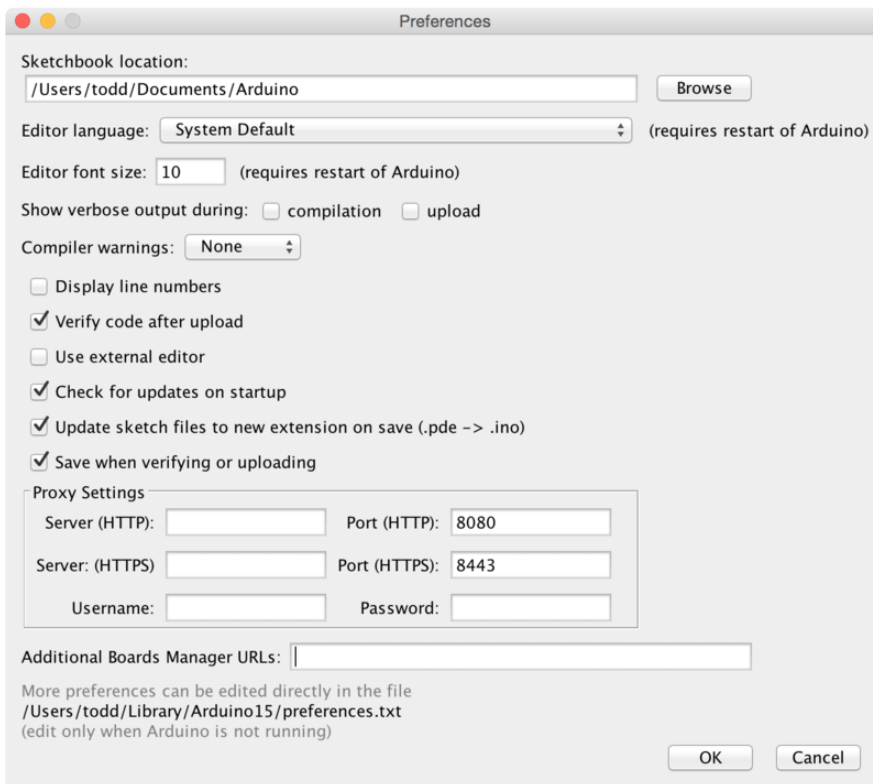

We will be adding a URL to the new Additional Boards Manager URLs option. The list of URLs is comma separated, and you will only have to add each URL once. New Adafruit boards and updates to existing boards will automatically be picked up by the Board Manager each time it is opened. The URLs point to index files that the Board Manager uses to build the list of available & installed boards.

To find the most up to date list of URLs you can add, you can visit the list of [third party board URLs on the Arduino IDE wiki \(https://adafru.it/f7U\)](https://adafru.it/f7U). We will only need to add one URL to the IDE in this example, but you can add multiple URLs by separating them with commas. Copy and paste the link below into the Additional Boards Manager URLs option in the Arduino IDE preferences.

https://adafruit.github.io/arduino-board-index/package_adafruit_index.json

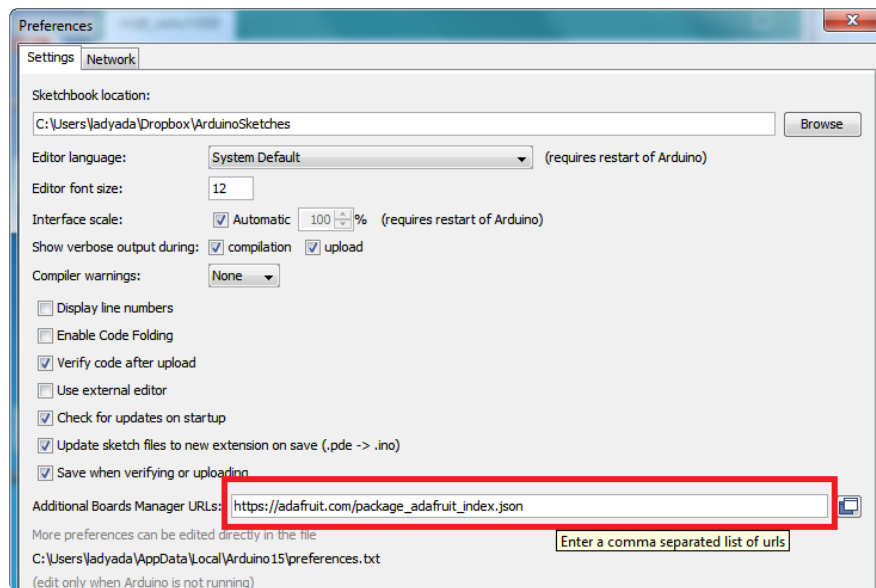

Here's a short description of each of the Adafruit supplied packages that will be available in the Board Manager when you add the URL:

- Adafruit AVR Boards - Includes support for Flora, Gemma, Feather 32u4, ItsyBitsy 32u4, Trinket, & Trinket Pro.
- Adafruit SAMD Boards - Includes support for Feather M0 and M4, Metro M0 and M4, ItsyBitsy M0 and M4, Circuit Playground Express, Gemma M0 and Trinket M0
- Arduino Leonardo & Micro MIDI-USB - This adds MIDI over USB support for the Flora, Feather 32u4, Micro and Leonardo using the [arcore project \(https://adafru.it/eSI\)](https://adafru.it/eSI).

If you have multiple boards you want to support, say ESP8266 and Adafruit, have both URLs in the text box separated by a comma (,)

Once done click OK to save the new preference settings. Next we will look at installing boards with the Board Manager.

Now continue to the next step to actually install the board support package!

Using with Arduino IDE

The Feather/Metro/Gemma/QTPy/Trinket M0 and M4 use an ATSAM21 or ATSAM51 chip, and you can pretty easily get it working with the Arduino IDE. Most libraries (including the popular ones like NeoPixels and display) will work with the M0 and M4, especially devices & sensors that use I2C or SPI.

Now that you have added the appropriate URLs to the Arduino IDE preferences in the previous page, you can open the Boards Manager by navigating to the Tools->Board menu.

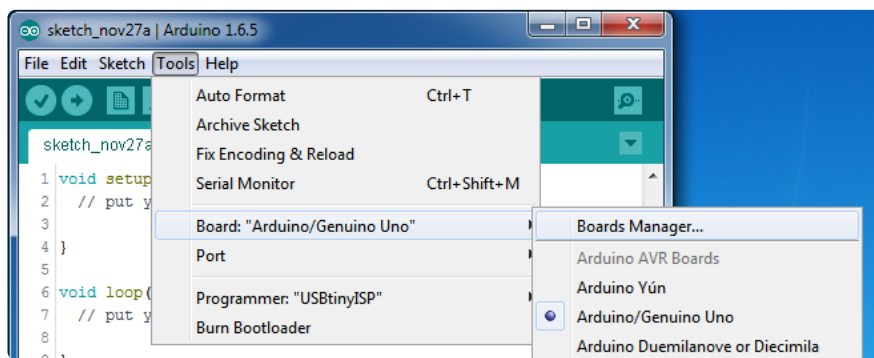

Once the Board Manager opens, click on the category drop down menu on the top left hand side of the window and select All. You will then be able to select and install the boards supplied by the URLs added to the preferences.

Remember you need SETUP the Arduino IDE to support our board packages - see the previous page on how to add adafruit's URL to the preferences

Install SAMD Support

First up, install the latest Arduino SAMD Boards (version 1.6.11 or later)

You can type Arduino SAMD in the top search bar, then when you see the entry, click I nstall

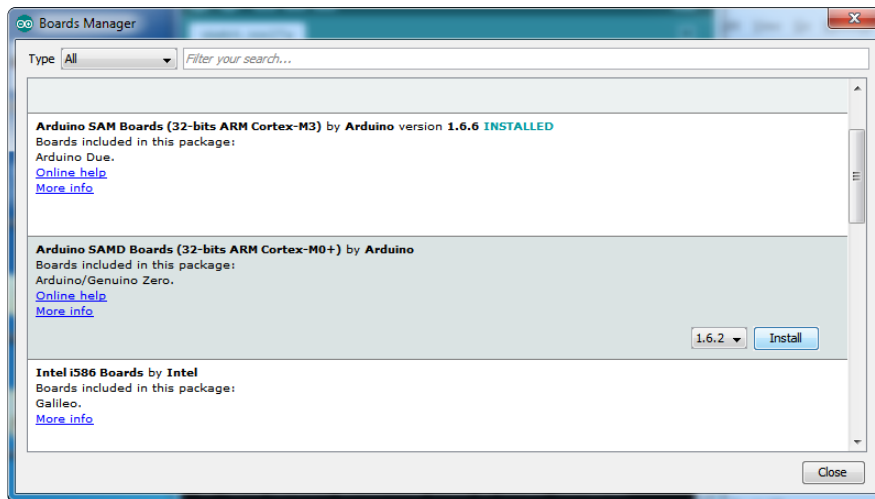

Install Adafruit SAMD

Next you can install the Adafruit SAMD package to add the board file definitions

Make sure you have Type All selected to the left of the Filter your search... box

You can type Adafruit SAMD in the top search bar, then when you see the entry, click Install

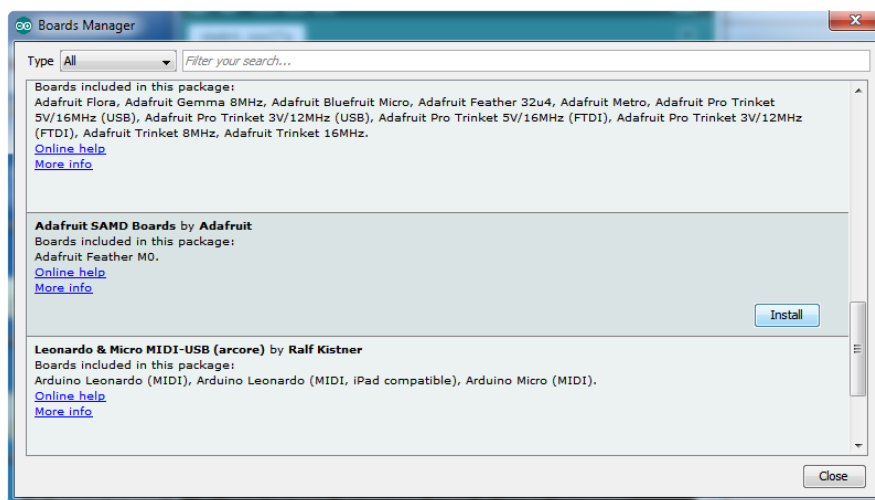

Even though in theory you don't need to - I recommend rebooting the IDE

Quit and reopen the Arduino IDE to ensure that all of the boards are properly installed. You should now be able to select and upload to the new boards listed in the Tools->Board menu.

Select the matching board, the current options are:

- Feather M0 (for use with any Feather M0 other than the Express)
- Feather M0 Express
- Metro M0 Express
- Circuit Playground Express
- Gemma M0
- Trinket M0
- QT Py M0
- ItsyBitsy M0
- Hallowing M0
- Crickit M0 (this is for direct programming of the Crickit, which is probably not what you want! For advanced hacking only)
- Metro M4 Express
- Grand Central M4 Express
- ItsyBitsy M4 Express
- Feather M4 Express
- Trellis M4 Express
- PyPortal M4
- PyPortal M4 Titano
- PyBadge M4 Express
- Metro M4 Airlift Lite
- PyGamer M4 Express
- MONSTER M4SK
- Hallowing M4
- MatrixPortal M4
- BLM Badge

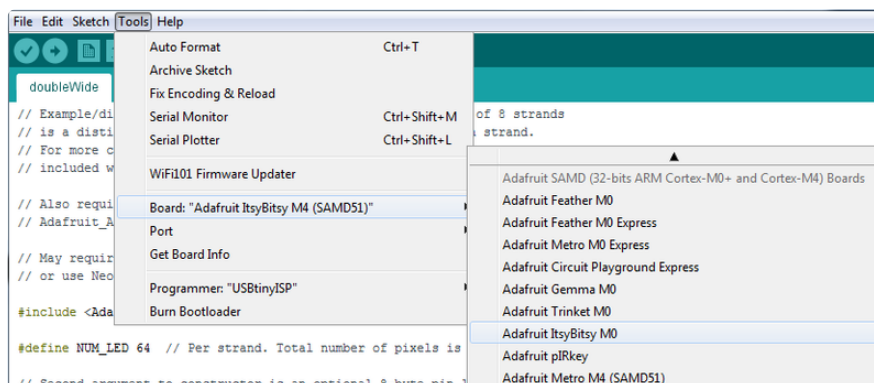

Install Drivers (Windows 7 & 8 Only)

When you plug in the board, you'll need to possibly install a driver

Click below to download our Driver Installer

Download Latest Adafruit Drivers
package

<https://adafru.it/mb8>

Download and run the installer

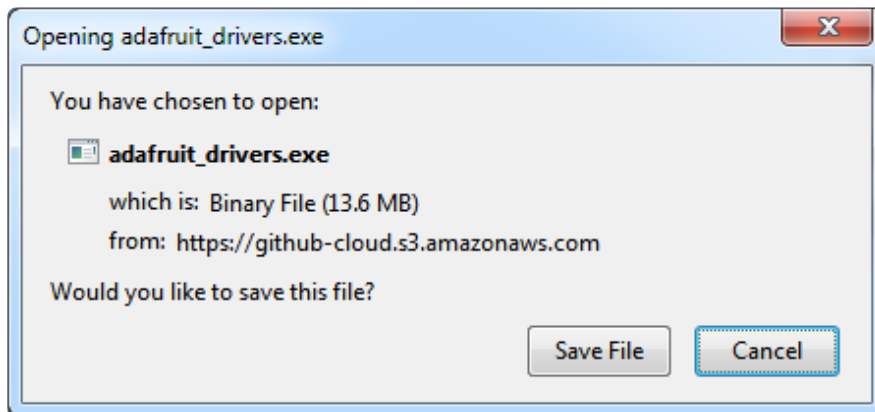

Run the installer! Since we bundle the SiLabs and FTDI drivers as well, you'll need to click through the license

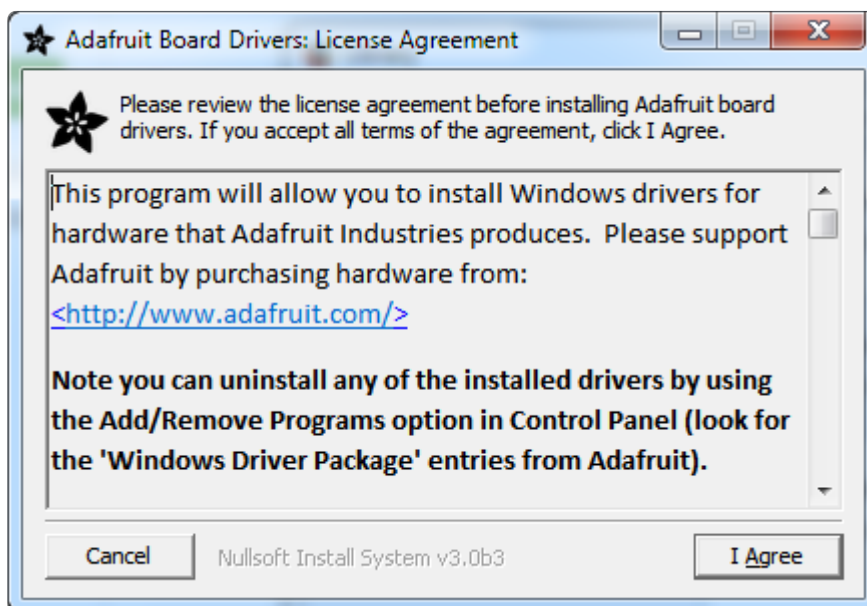

Select which drivers you want to install, the defaults will set you up with just about every Adafruit board!

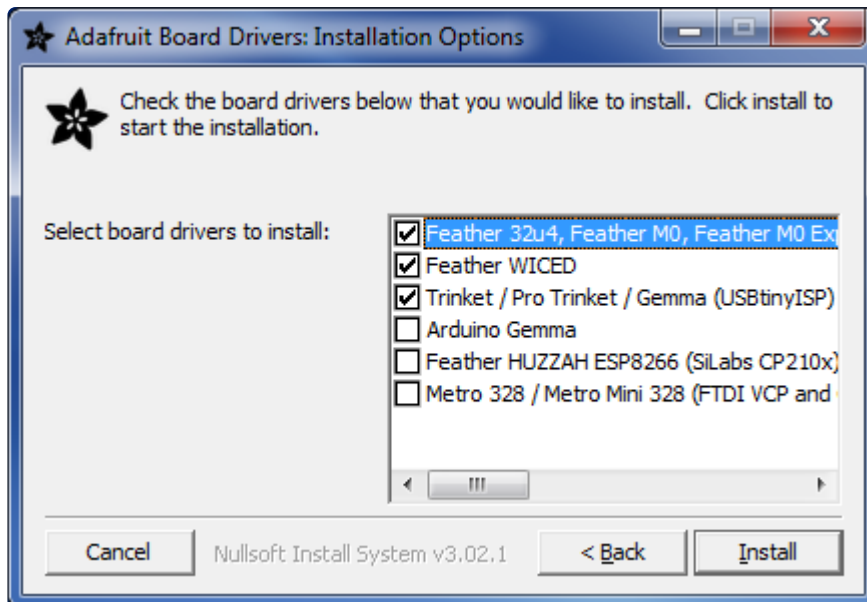

Click Install to do the installin'

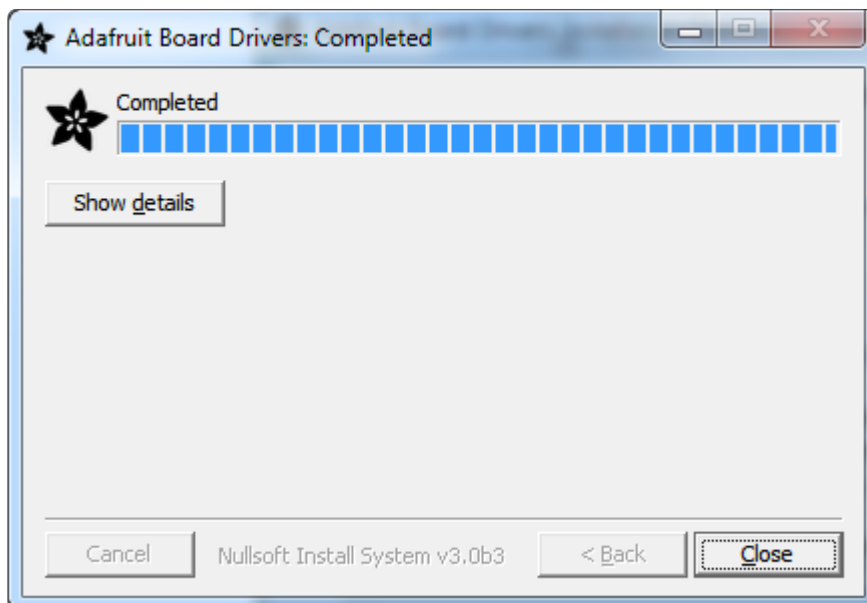

Blink

Now you can upload your first blink sketch!

Plug in the M0 or M4 board, and wait for it to be recognized by the OS (just takes a few seconds). It will create a serial/COM port, you can now select it from the drop-down, it'll even be 'indicated' as Trinket/Gemma/Metro/Feather/ItsyBitsy/Trellis!

Please note, the QT Py and Trellis M4 Express are two of our very few boards that does not have an onboard pin 13 LED so you can follow this section to practice uploading but you wont see an LED blink!

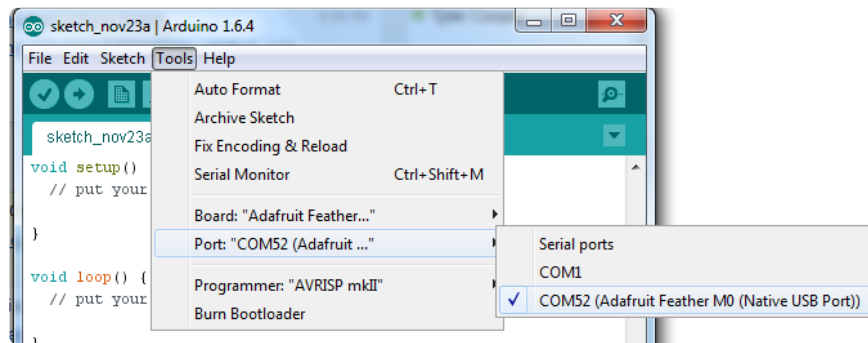

Now load up the Blink example

```
// the setup function runs once when you press reset or power the board
void setup() {
  // initialize digital pin 13 as an output.
  pinMode(13, OUTPUT);
}

// the loop function runs over and over again forever
void loop() {
  digitalWrite(13, HIGH); // turn the LED on (HIGH is the voltage level)
  delay(1000);           // wait for a second
  digitalWrite(13, LOW); // turn the LED off by making the voltage LOW
  delay(1000);           // wait for a second
}
```

And click upload! That's it, you will be able to see the LED blink rate change as you adapt the delay() calls.

If you are having issues, make sure you selected the matching Board in the menu that matches the hardware you have in your hand.

Successful Upload

If you have a successful upload, you'll get a bunch of red text that tells you that the device was found and it was programmed, verified & reset

```
Done uploading.
Write 11024 bytes to flash (173 pages)

[=====          ] 36% (64/173 pages)
[=====          ] 73% (128/173 pages)
[=====          ] 100% (173/173 pages)

done in 0.097 seconds

Verify 11024 bytes of flash with checksum.

Verify successful

done in 0.049 seconds

CPU reset.
```

6 Adafruit Feather M0 (Native USB Port) on COM54

After uploading, you may see a message saying "Disk Not Ejected Properly" about the ...BOOT drive. You can ignore that message: it's an artifact of how the bootloader and uploading work.

Compilation Issues

If you get an alert that looks like

Cannot run program "{runtime.tools.arm-none-eabi-gcc.path}\bin\arm-non-eabi-g++"

Make sure you have installed the Arduino SAMD boards package, you need both Arduino & Adafruit SAMD board packages

```
Cannot run program "{runtime.tools.arm-none-eabi-gcc.path}\bin\arm-non-eabi-g++" Copy error messages

{runtime.tools.arm-none-eabi-gcc.path}/bin/arm-none-eabi-g++ -mcpu=cortex-m0plus -mth
max-inline-insns-single=500 -fno-rtti -fno-exceptions -MMD -DF_CPU=48000000L -DARDUIN
-DUSB_MANUFACTURER="Adafruit" -DUSB_PRODUCT="Feather M0" -I{runtime.tools.CMSIS.path}
-IC:\Users\ladyada\AppData\Roaming\Arduino15\packages\adafruit\hardware\samd\1.0.2\co
-IC:\Users\ladyada\AppData\Roaming\Arduino15\packages\adafruit\hardware\samd\1.0.2\va
-IC:\Users\ladyada\AppData\Roaming\Arduino15\packages\adafruit\hardware\samd\1.0.2\li
-IC:\Users\ladyada\Dropbox\ArduinoSketches\libraries\WINC1500\src C:\Users\ladyada\Ap
C:\Users\ladyada\AppData\Local\Temp\build5777565695508348365.tmp\mqtt_winc1500.cpp.o

Cannot run program "{runtime.tools.arm-none-eabi-gcc.path}\bin\arm-non-eabi-g++" (in
```

1 Adafruit Feather M0 (Native USB Port) on COM11

Manually bootloading

If you ever get in a 'weird' spot with the bootloader, or you have uploaded code that crashes and doesn't auto-reboot into the bootloader, click the RST button twice (like a double-click) to get back into the bootloader.

The red LED will pulse and/or RGB LED will be green, so you know that its in bootloader mode.

Once it is in bootloader mode, you can select the newly created COM/Serial port and re-try uploading.

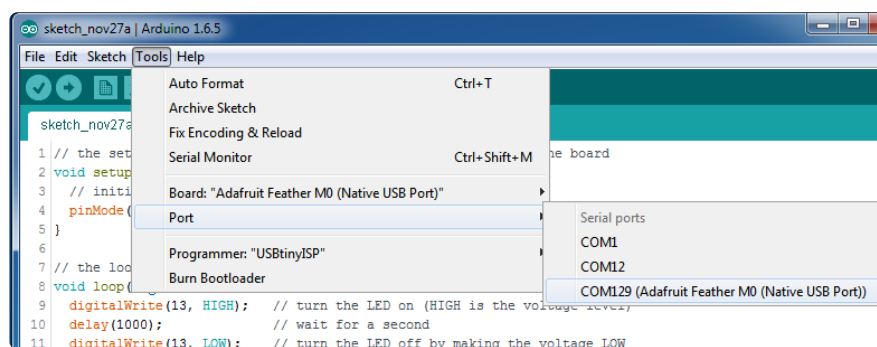

You may need to go back and reselect the 'normal' USB serial port next time you want to use the normal upload.

Ubuntu & Linux Issue Fix

[Follow the steps for installing Adafruit's udev rules on this page. \(https://adafru.it/iOE\)](https://adafru.it/iOE)

Using the WiFi Module

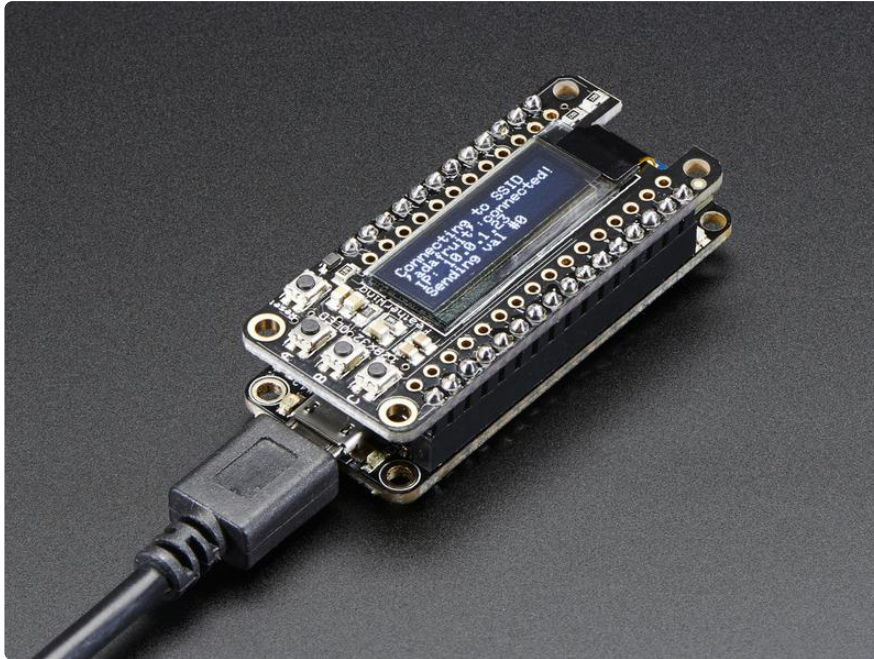

Once you have your Feather working, you probably want to rock out with some Wireless connectivity. Luckily, Atmel & Arduino have written a great library for supporting the WINC1500

Install the Library

We will start by installing the [official Arduino WiFi101 library \(https://adafru.it/kUF\)](https://adafru.it/kUF).

We want the latest version so visit the Library Manager

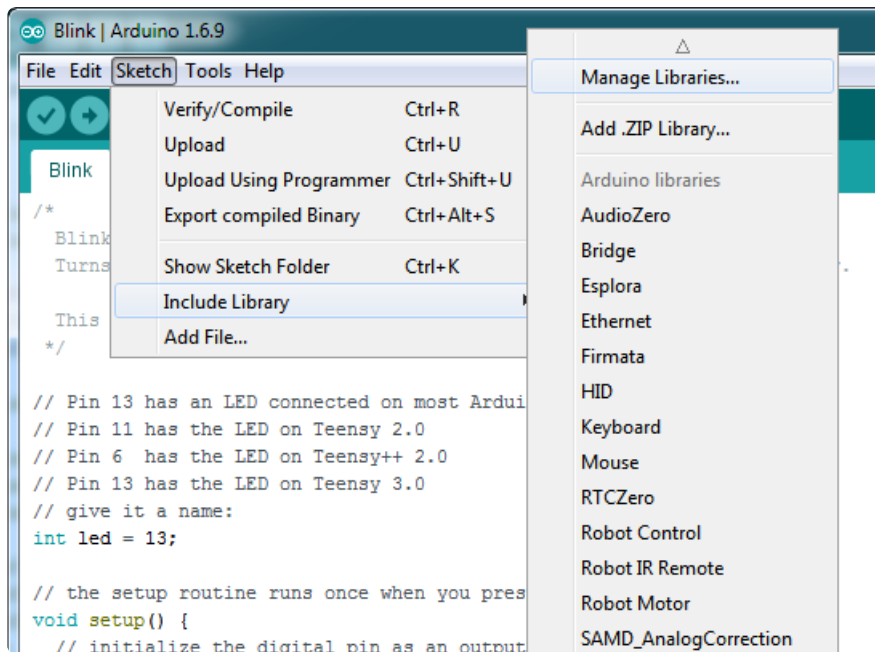

Type in wifi101 and when the library comes up, click Install or Update to make sure its the most recent one!

If you're not familiar with installing Arduino libraries, please visit our tutorial: [All About Arduino Libraries \(https://adafru.it/aYM\)](https://adafru.it/aYM)!

Restart the Arduino IDE.

You may need to use Arduino 1.6.5 or later

Check Connections & Version

Before we start, its important to verify you have the right setup & firmware version.

Load up the WiFi101->CheckWifi101Firmware sketch

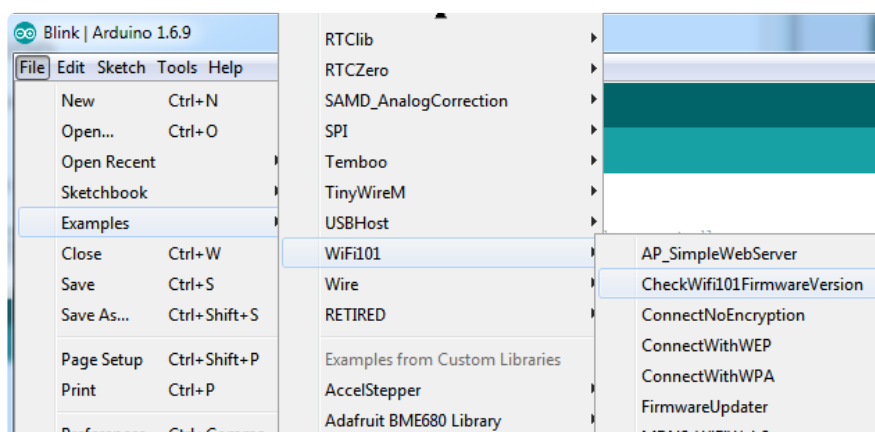

Note that to use the official Arduino WiFi101 Library, we must configure it to use the pins specific to the ATWINC1500 Feather. With each example sketch, you'll need to add `WiFi.setPins(8,7,4,2);` to the top of the setup function!

```
//Configure pins for Adafruit ATWINC1500 Feather
WiFi.setPins(8,7,4,2);
```

Like so:

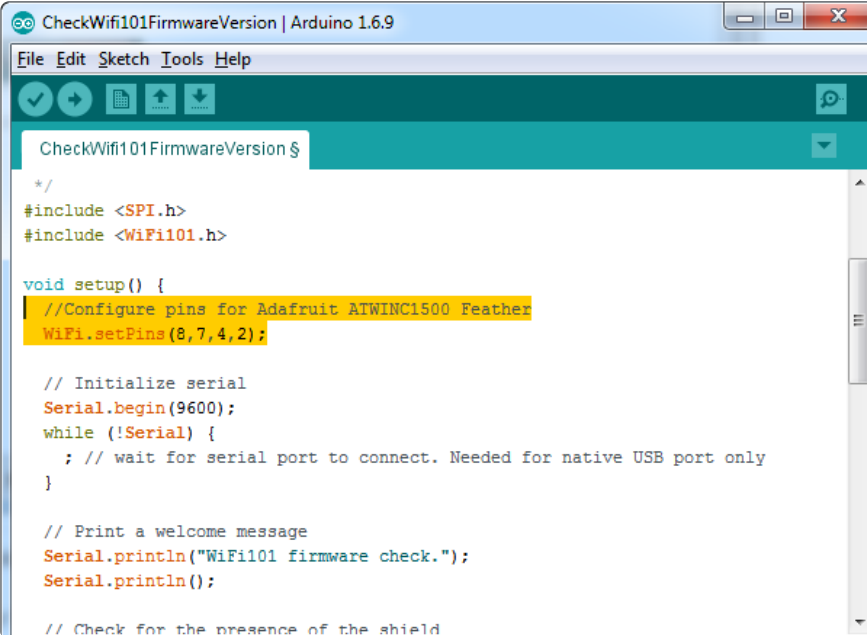

```
CheckWifi101FirmwareVersion $
*/
#include <SPI.h>
#include <WiFi101.h>

void setup() {
  //Configure pins for Adafruit ATWINC1500 Feather
  WiFi.setPins(8,7,4,2);

  // Initialize serial
  Serial.begin(9600);
  while (!Serial) {
    ; // wait for serial port to connect. Needed for native USB port only
  }

  // Print a welcome message
  Serial.println("WiFi101 firmware check.");
  Serial.println();

  // Check for the presence of the shield
```

Upload to your Arduino and open up the Serial Console at 9600 baud:

You should see the firmware version. If your firmware hasn't PASSED, [use the firmware updater to get the latest, its easy!](https://adafru.it/vfe) (<https://adafru.it/vfe>)

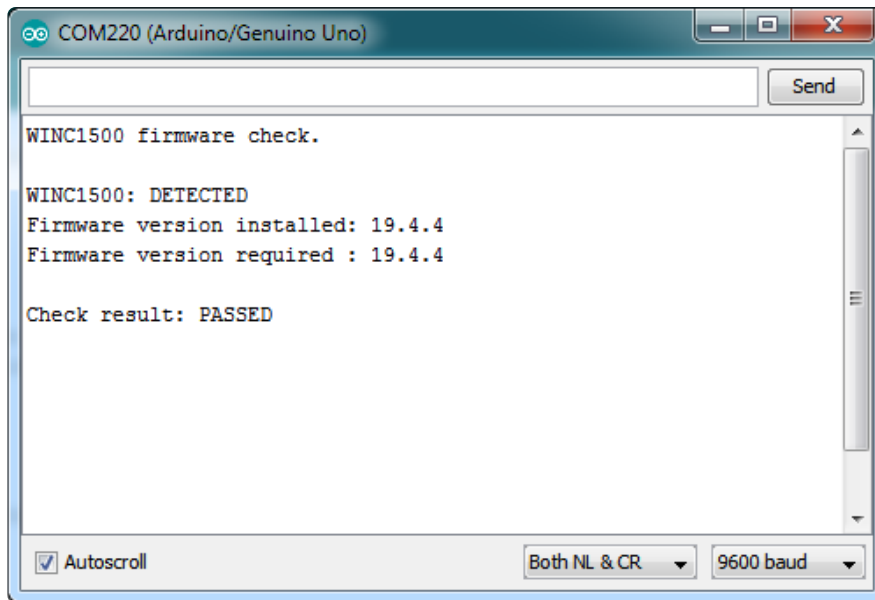

If you have version 19.3 or less, the firmware is too old

If you get not response, the firmware is either waaay to old, or something is amiss with your wiring!

Scanning WiFi

Now that you have the right firmware version, lets scan for network!

Run the WiFi101->ScanNetworks example to see a list of available visible networks

Don't forget to add `WiFi.setPins(8,7,4,2)` at the top of setup()

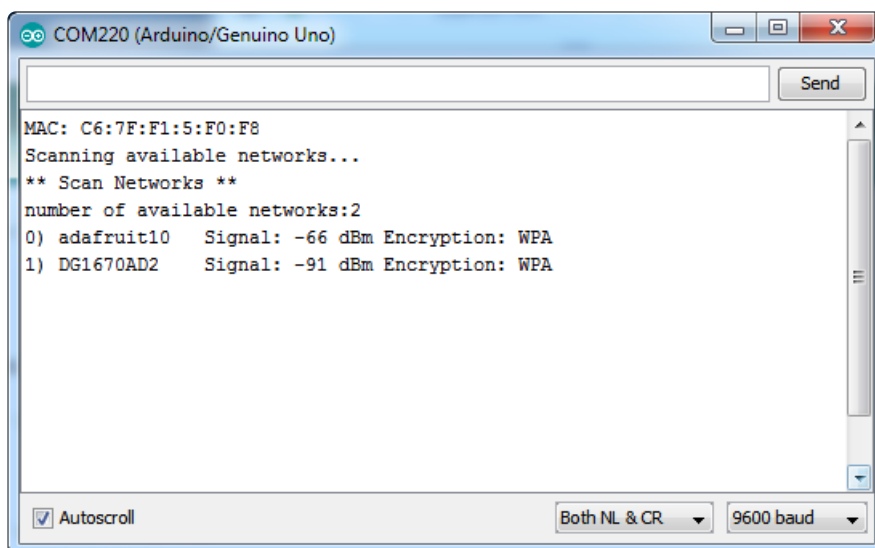

Connect & Read Webpage

OK finally you get to connect and read some data!

Open up the WiFi101->WiFiWebClient example

Edit the ssid and pass variables to contain your network and password

```
34
35
36 char ssid[] = "adafruit"; // your network SSID (name)
37 char pass[] = "supersekret"; // your network password (use for WPA, or use as key for WEP)
38 int keyIndex = 0; // your network key Index number (needed only for WEP)
39
40 int status = WL_IDLE_STATUS;
41 // if you don't want to use DNS (and reduce your sketch size)
42 // use the numeric IP instead of the name for the server:
```

Add the following lines at the top of setup()

```
//Configure pins for Adafruit ATWINC1500 Feather
WiFi.setPins(8,7,4,2);
```

It will connect to the website in server and read the webpage manually:

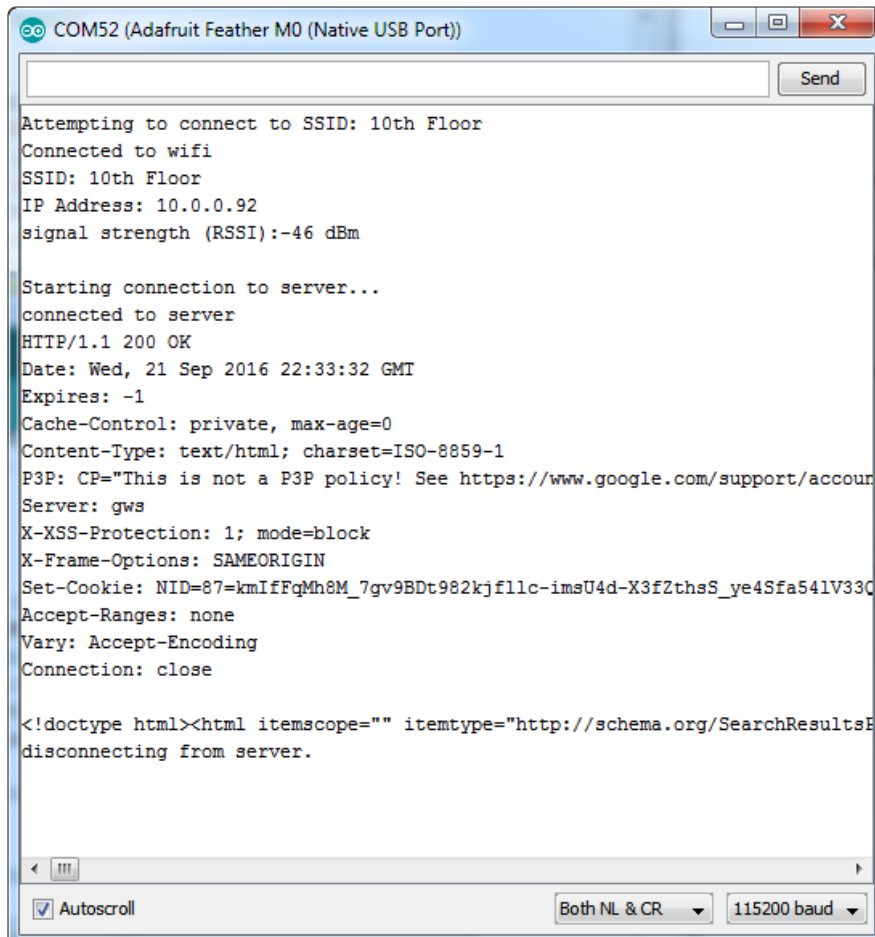

Creating an Access Point + Webserver

This demo will let you create a new WiFi AP with the Feather M0 which you can connect to from any WiFi capable device. It will also create a Server so you can connect and turn on/off the onboard LED

Launch the WiFi101->AP_SimpleWebServer example

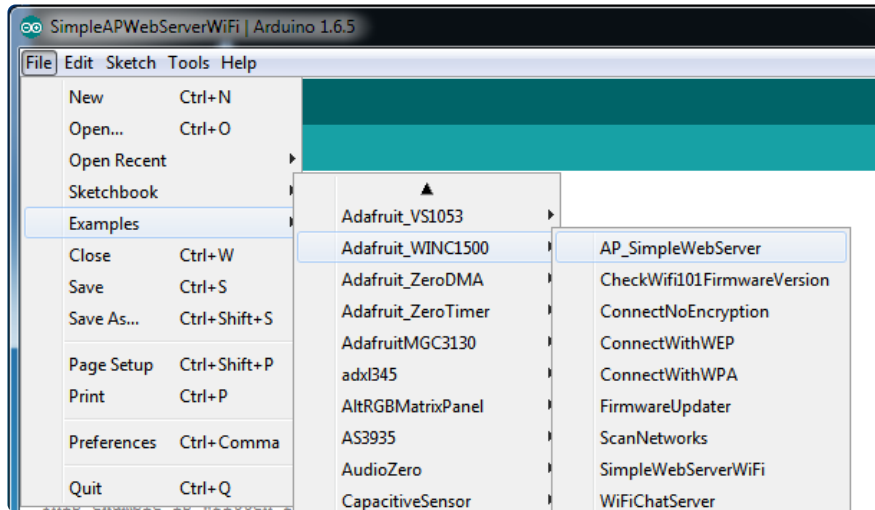

You can change the SSID & LED (`LED_BUILTIN` is #13, the onboard feather LED)

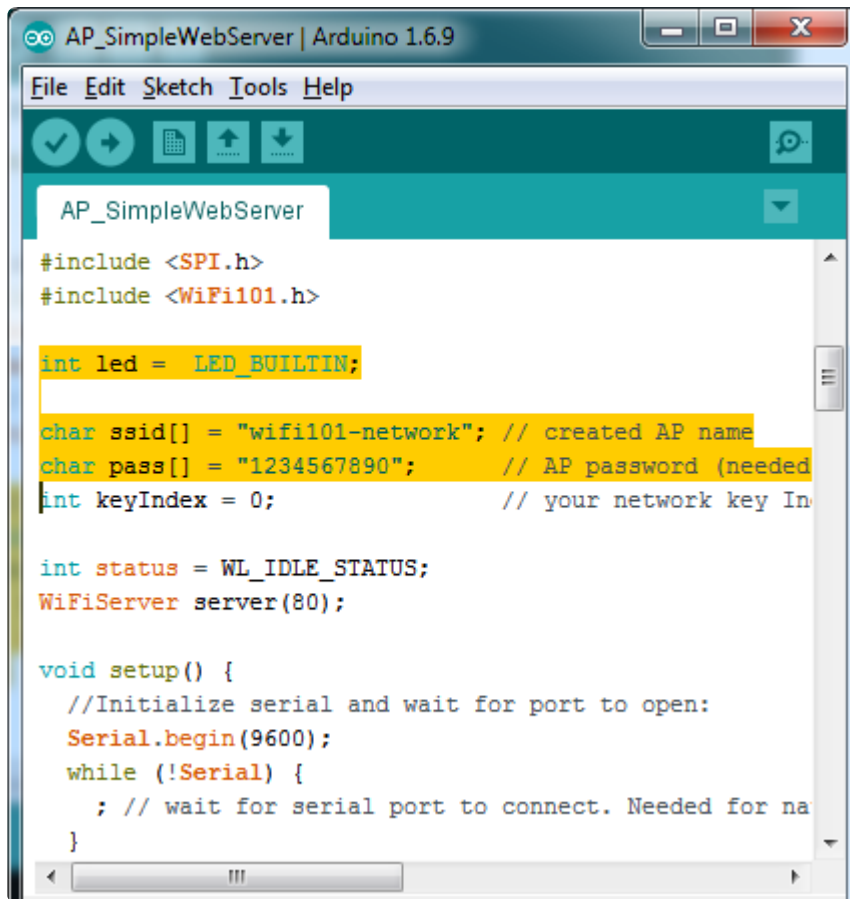

```
AP_SimpleWebServer | Arduino 1.6.9
File Edit Sketch Tools Help
AP_SimpleWebServer
#include <SPI.h>
#include <WiFi101.h>

int led = LED_BUILTIN;

char ssid[] = "wifi101-network"; // created AP name
char pass[] = "1234567890"; // AP password (needed
int keyIndex = 0; // your network key In

int status = WL_IDLE_STATUS;
WiFiServer server(80);

void setup() {
  //Initialize serial and wait for port to open:
  Serial.begin(9600);
  while (!Serial) {
    ; // wait for serial port to connect. Needed for na
  }
}
```

Upload and open up the serial console to start the AP

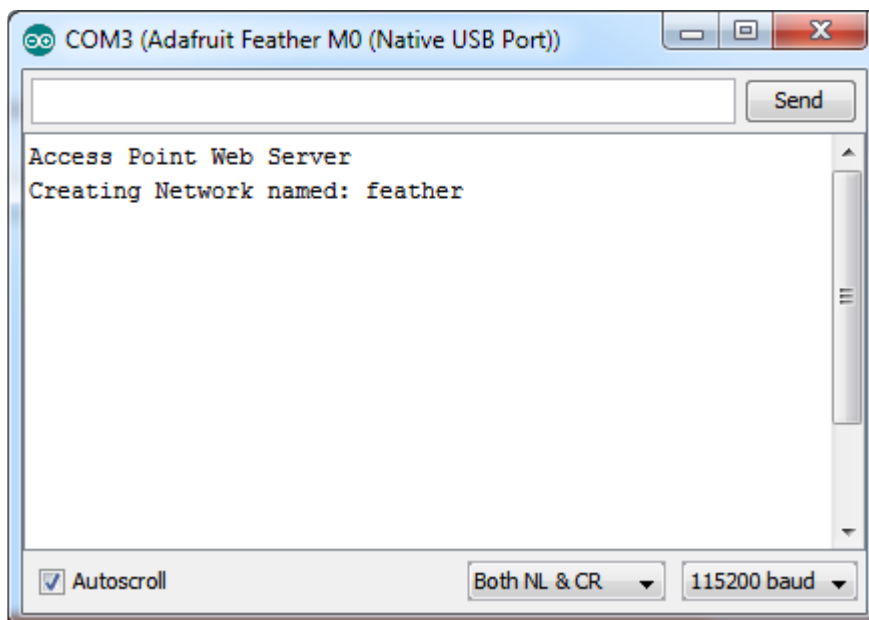

```
COM3 (Adafruit Feather M0 (Native USB Port))
Send
Access Point Web Server
Creating Network named: feather
Autoscroll Both NL & CR 115200 baud
```

Your computer will see the new AP and you should connect to it

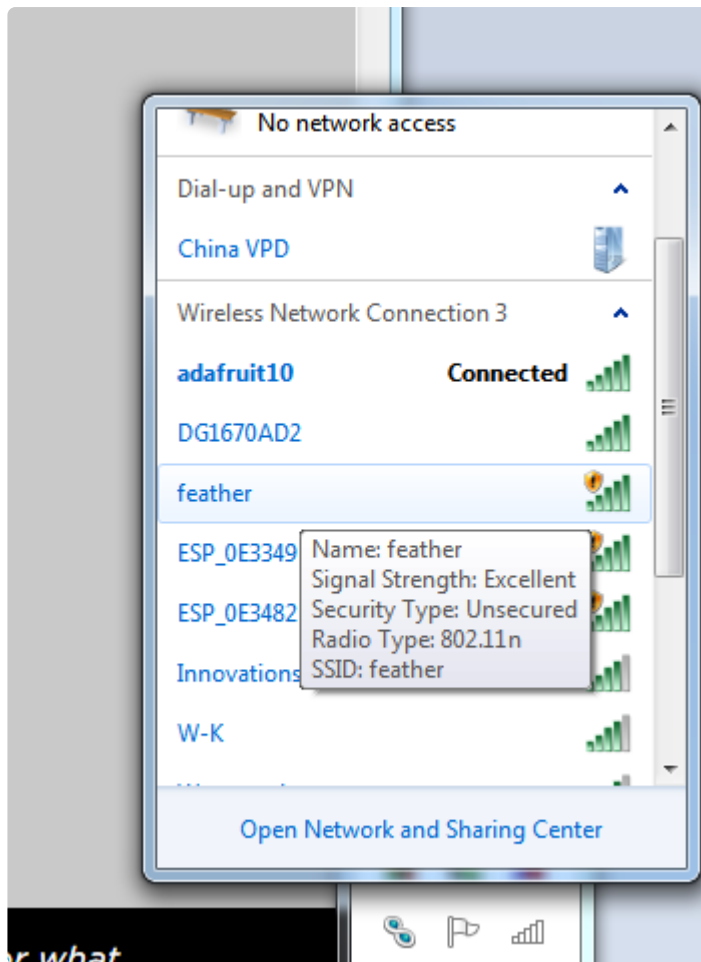

Back over at the serial console, the Feather will have started up a server, it will print out the IP address and instructions

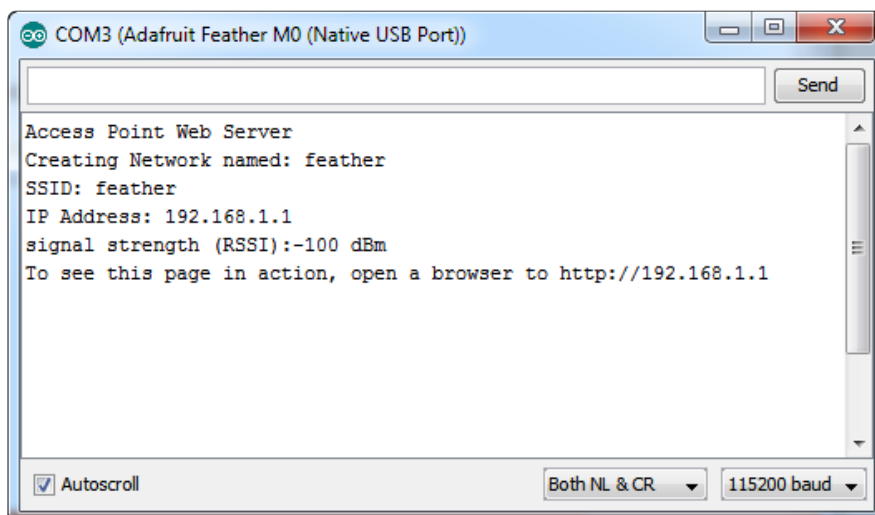

Go to the IP address and you will see the mini webpage, click on the links to turn on/off the LED

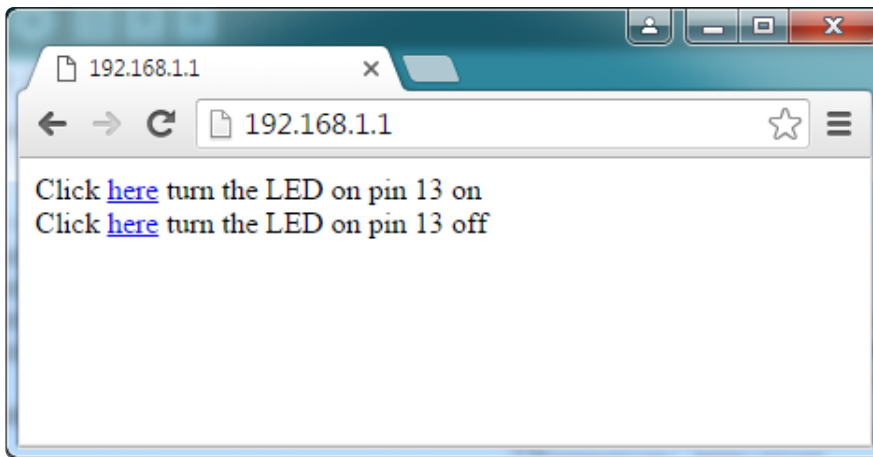

In the serial console you will see the data received from the webbrowser client

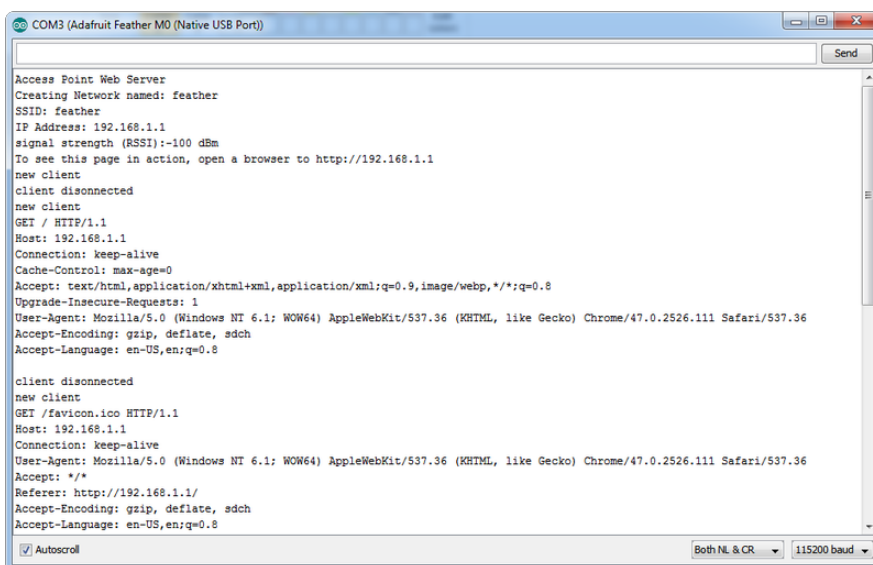

That's it! pretty easy, huh? There's other examples you can try such as server mode, UDP data transmission & SSL

Updating Firmware

If you're running 19.5.2 there is no need to update to 19.5.4, despite what the WiFi101 library says it should work just fine and you could brick your device by updating, it is not perfectly foolproof! Thanks :)

As new versions of the WiFi101 library come out, you may end up getting a complaint that the library and WINC1500 firmware are out of sync:

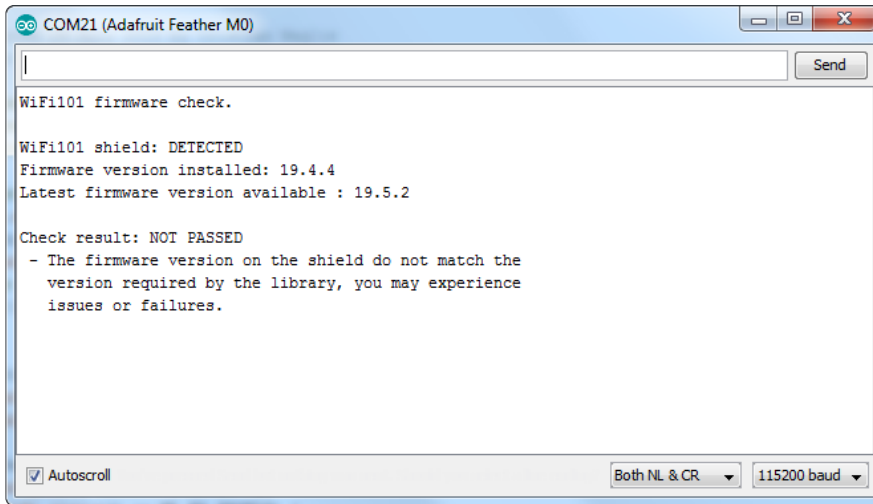

No problem - you can update the firmware through your Arduino/compatible! Start by loading up the FirmwareUpdater sketch

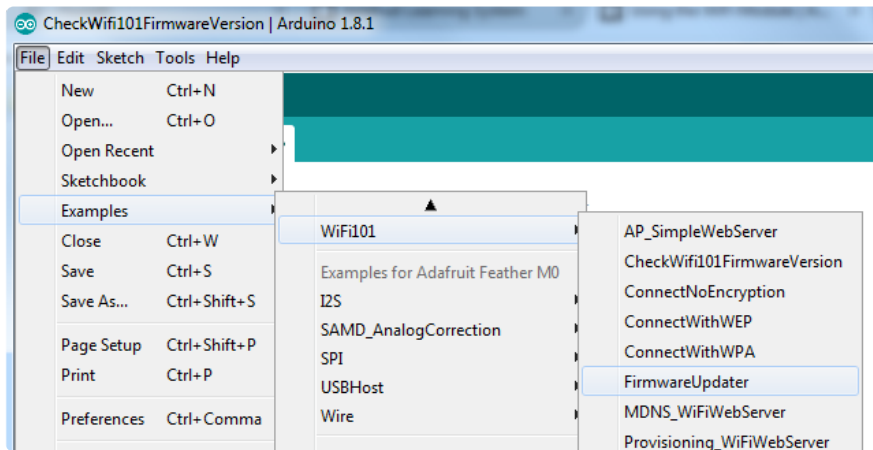

If you are using a Feather M0 or WINC1500 breakout, don't forget to update the pins as necessary with `setPins()`!

If you are using a WiFi101 or WINC1500 shield, you do not have to add `setPins()` code

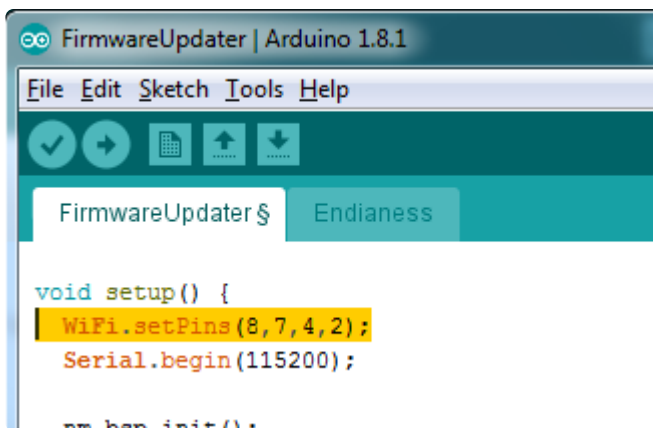

Upload it to your board. Make sure the Serial console is not open before or after uploading.

Then select the Updater tool built into the IDE

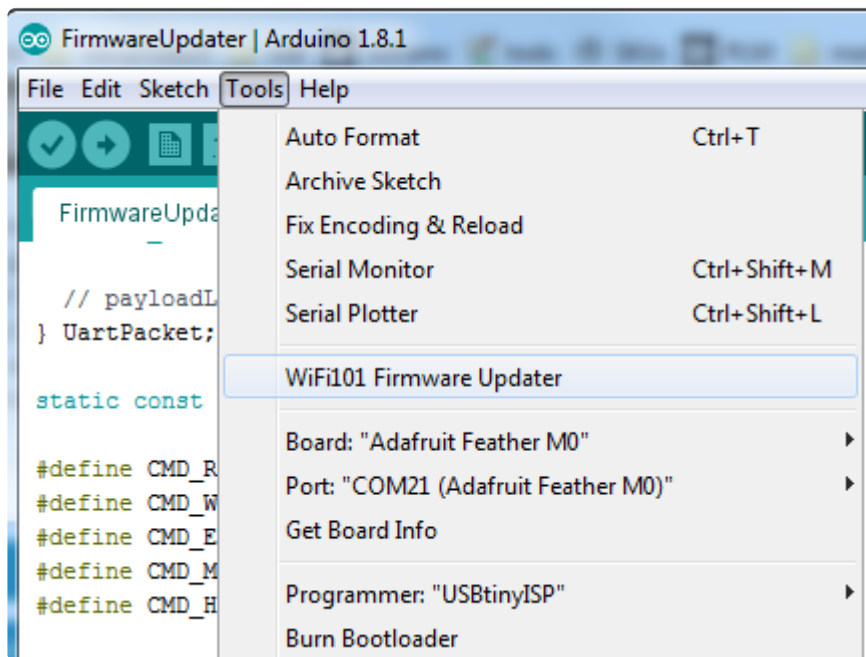

Select the right COM port, and click Test Connection

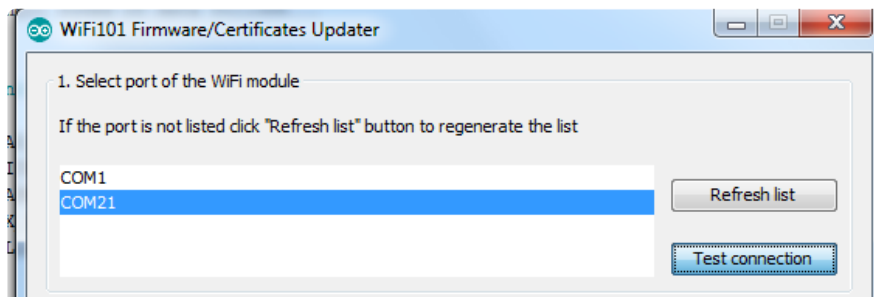

If all is good you'll get a confirmation

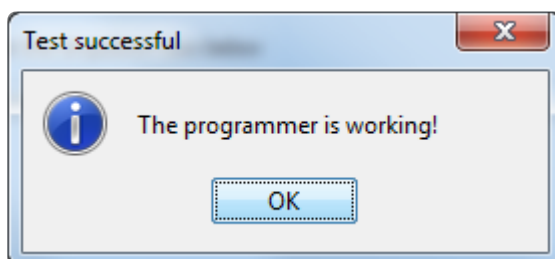

Next, select the firmware - we of course recommend the latest version!

If you don't see the right/matching version you may need to update the IDE

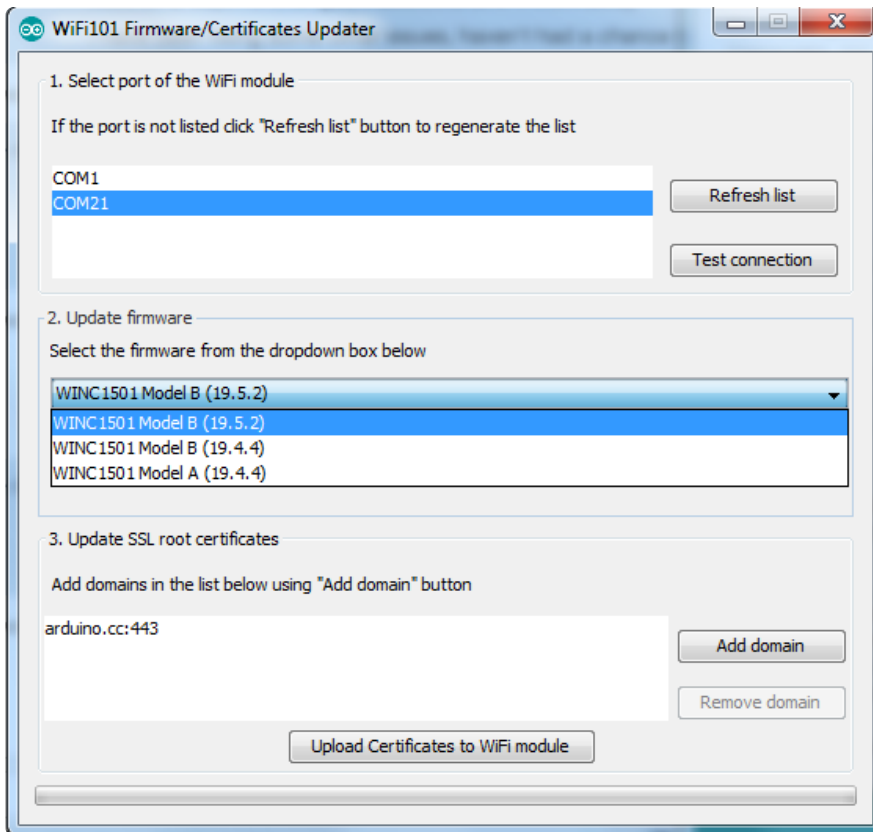

Once you feel ready - make sure the USB cable is connected solidly! Click Update Firmware

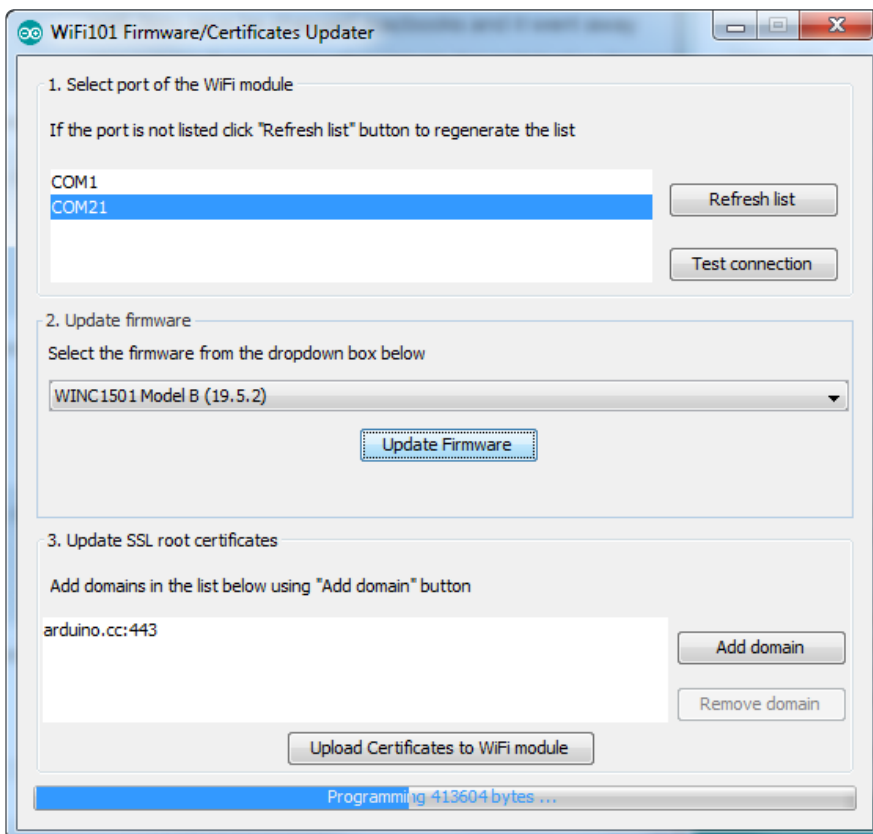

And a minute or two later...

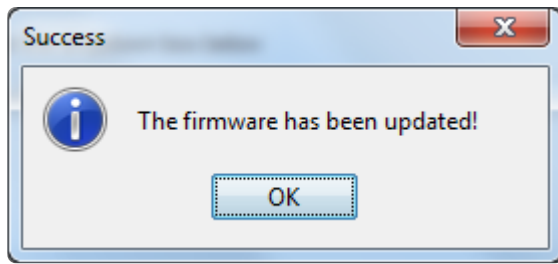

Now you're ready to rock! Reload the Firmware Check sketch from before, this time you will see:

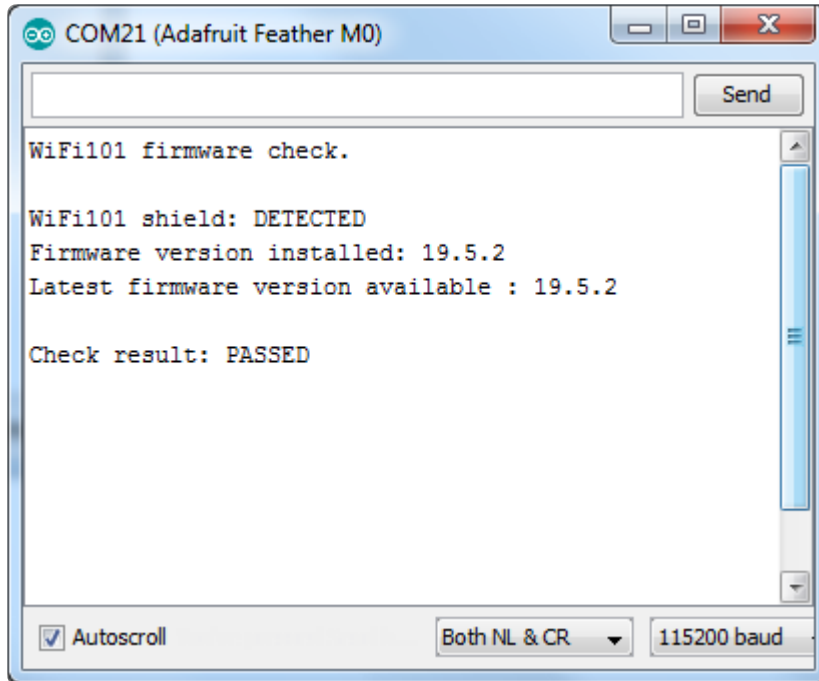

Updating SSL Certificates

If you're trying to connect to a computer or service via SSL and the connection is failing, you may need to update the certificates built into the WINC1500. By default it comes with many of the most popular SSL certificates but you may bump into a site that requires one that isn't included.

It's quite easy to update the certificates, you'll need to upload some code and run the uploaders but it only has to happen once.

Start out by uploading the FirmwareUpdater sketch from WiFi101

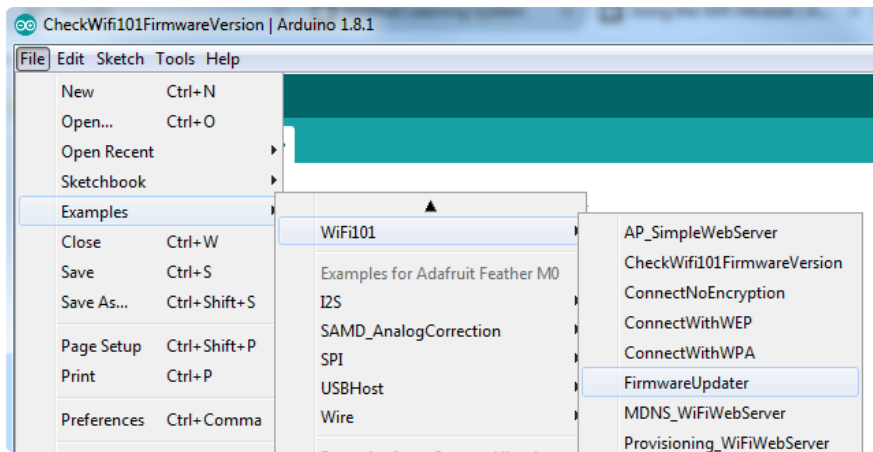

If you are using a Feather M0 or WINC1500 breakout, don't forget to update the pins as necessary with `setPins()`!

If you are using a WiFi101 or WINC1500 shield, skip this step

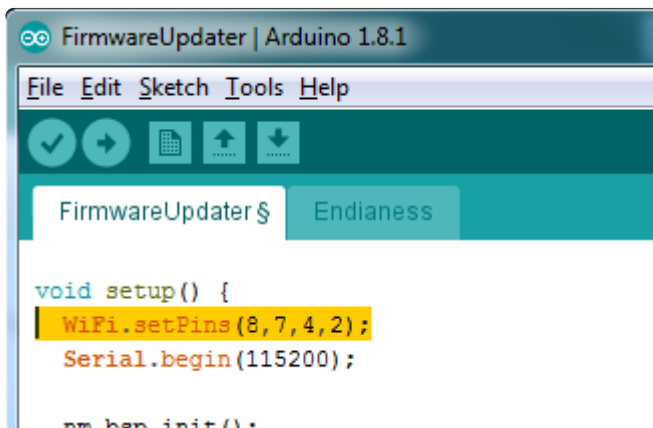

and upload it!

After uploading be sure to note what is the name of the COM or Serial port for the Arduino Zero or Feather...You'll need this for the next step

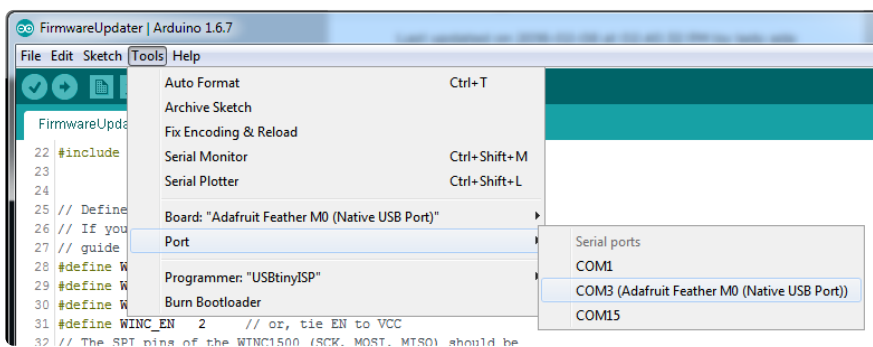

Upload it to your Feather. Make sure the Serial console is not open before or after uploading.

Then select the Updater tool built into the IDE

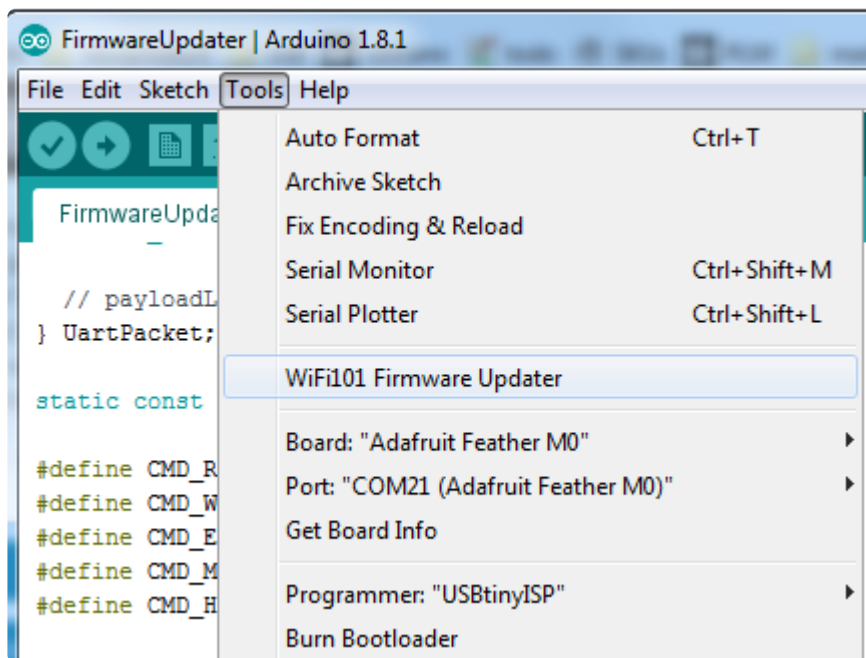

Select the right COM port, and click Test Connection

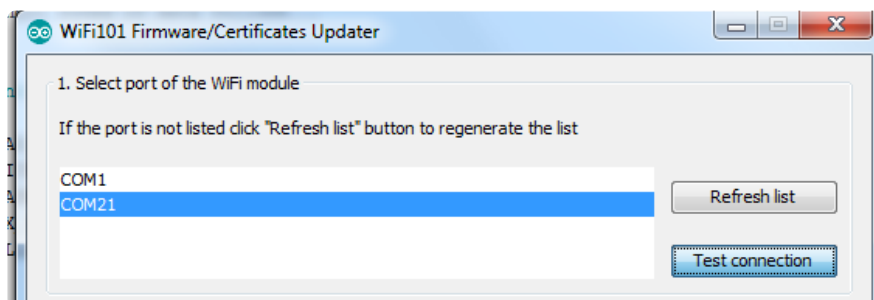

If all is good you'll get a confirmation

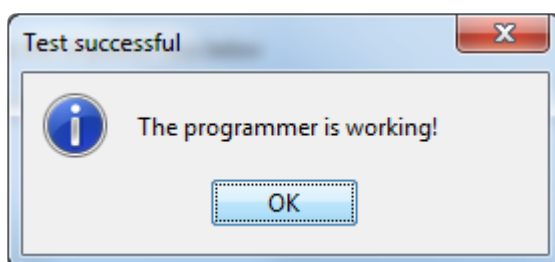

Now at the bottom of the page, click Add Domain and type in the URL of the site you want to access:

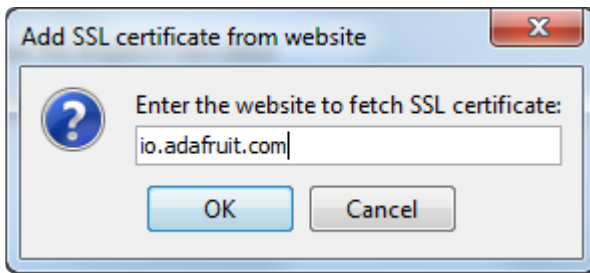

Then click Upload Certificates

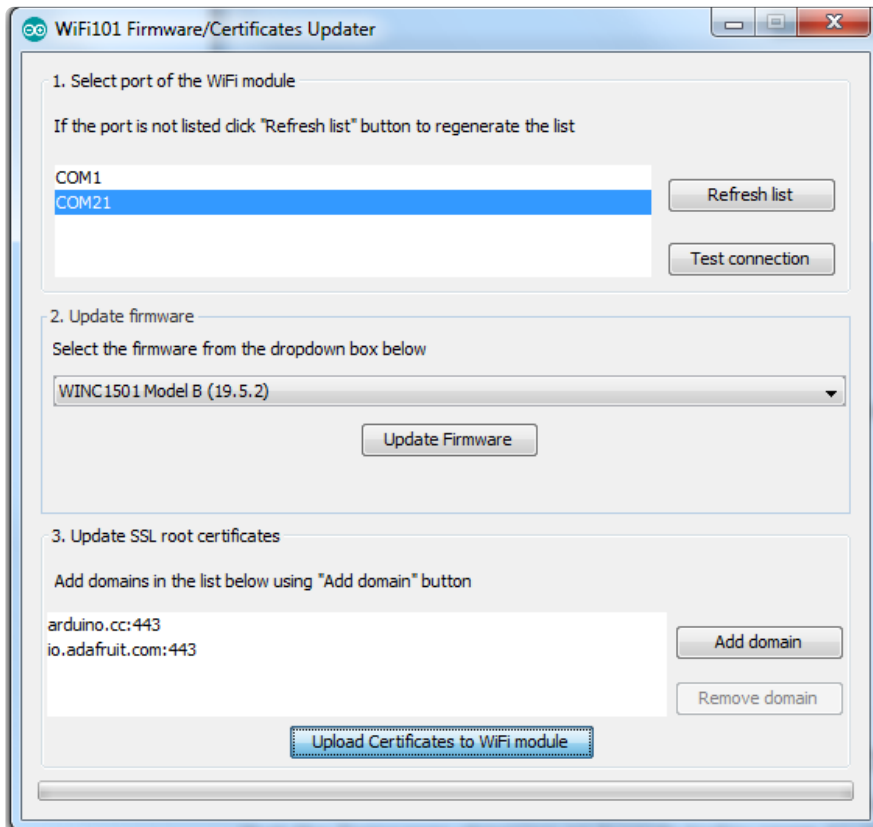

A few moments later...success!

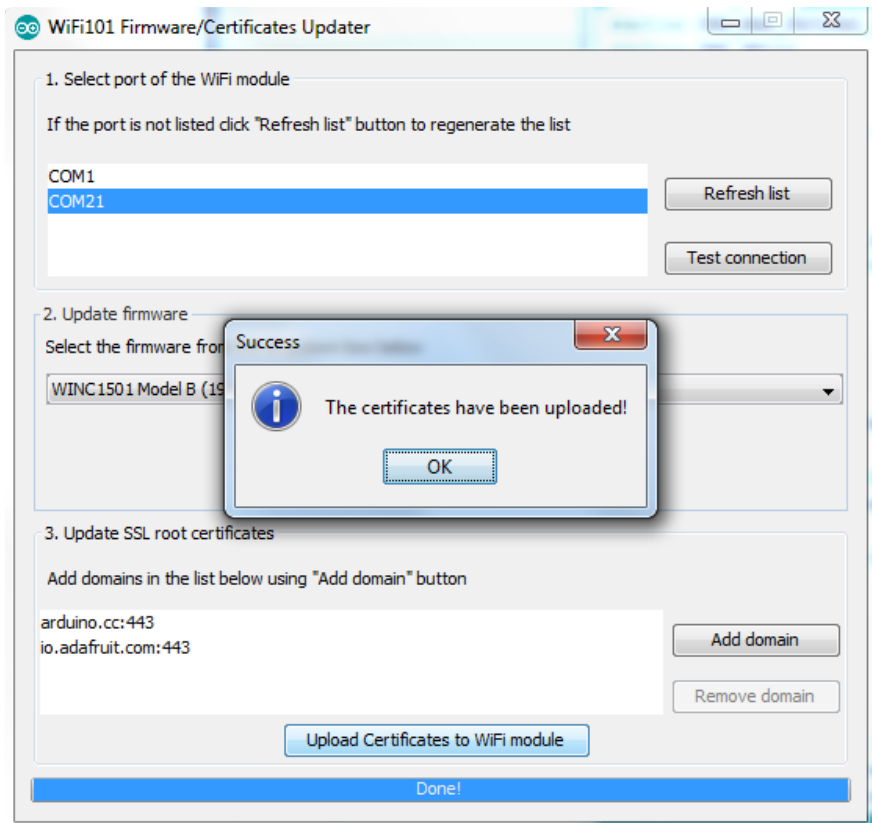

What SSL/TLS support is available with the WINC1500?

Officially Atmel lists TLS 1.0 & 1.1, however we have noticed that the firmwares shipping on boards today seem to also support TLS 1.2 (verified by checking the results of www.howssmyssl.com (<https://adafru.it/mgf>)).

The supported ciphers are:

- TLS_DHE_RSA_WITH_AES_128_GCM_SHA256
- TLS_RSA_WITH_AES_128_GCM_SHA256
- TLS_DHE_RSA_WITH_AES_128_CBC_SHA256
- TLS_DHE_RSA_WITH_AES_128_CBC_SHA
- TLS_RSA_WITH_AES_128_CBC_SHA256
- TLS_RSA_WITH_AES_128_CBC_SHA

Adapting Sketches to M0 & M4

The ATSAM21 and 51 are very nice little chips, but fairly new as Arduino-compatible cores go. Most sketches & libraries will work but here's a collection of things we noticed.

The notes below cover a range of Adafruit M0 and M4 boards, but not every rule will apply to every board (e.g. Trinket and Gemma M0 do not have ARef, so you can skip the Analog References note!).

Analog References

If you'd like to use the ARef pin for a non-3.3V analog reference, the code to use is `analogReference(AR_EXTERNAL)` (it's AR_EXTERNAL not EXTERNAL)

Pin Outputs & Pullups

The old-style way of turning on a pin as an input with a pullup is to use

```
pinMode(pin, INPUT)
digitalWrite(pin, HIGH)
```

This is because the pullup-selection register on 8-bit AVR chips is the same as the output-selection register.

For M0 & M4 boards, you can't do this anymore! Instead, use:

```
pinMode(pin, INPUT_PULLUP)
```

Code written this way still has the benefit of being backwards compatible with AVR. You don't need separate versions for the different board types.

Serial vs SerialUSB

99.9% of your existing Arduino sketches use Serial.print to debug and give output. For the Official Arduino SAMD/M0 core, this goes to the Serial5 port, which isn't exposed on the Feather. The USB port for the Official Arduino M0 core is called SerialUSB instead.

In the Adafruit M0/M4 Core, we fixed it so that Serial goes to USB so it will automatically work just fine.

However, on the off chance you are using the official Arduino SAMD core and not the Adafruit version (which really, we recommend you use our version because it's been tuned to our boards), and you want your Serial prints and reads to use the USB port, use SerialUSB instead of Serial in your sketch.

If you have existing sketches and code and you want them to work with the M0 without a huge find-replace, put

```
#if defined(ARDUINO_SAMD_ZERO) && defined(SERIAL_PORT_USBVIRTUAL)
  // Required for Serial on Zero based boards
  #define Serial SERIAL_PORT_USBVIRTUAL
#endif
```

right above the first function definition in your code. For example:

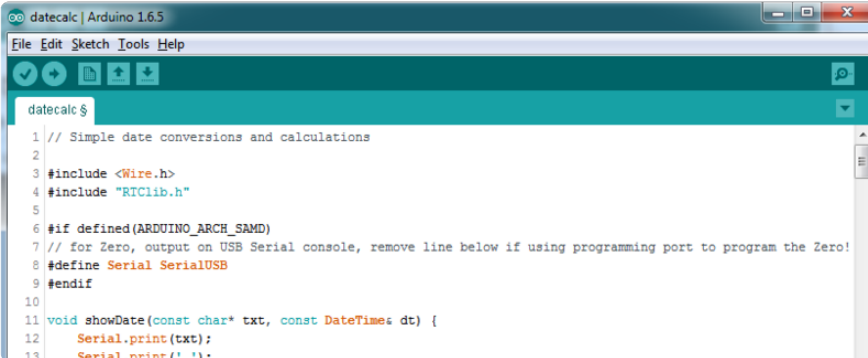

```
datecalc | Arduino 1.6.5
File Edit Sketch Tools Help
datecalc $
1 // Simple date conversions and calculations
2
3 #include <Wire.h>
4 #include "RTClib.h"
5
6 #if defined(ARDUINO_ARCH_SAMD)
7 // for Zero, output on USB Serial console, remove line below if using programming port to program the Zero!
8 #define Serial SerialUSB
9 #endif
10
11 void showDate(const char* txt, const DateTime& dt) {
12     Serial.print(txt);
13     Serial.println(' ');
```

AnalogWrite / PWM on Feather/Metro M0

After looking through the SAMD21 datasheet, we've found that some of the options listed in the multiplexer table don't exist on the specific chip used in the Feather M0.

For all SAMD21 chips, there are two peripherals that can generate PWM signals: The Timer/Counter (TC) and Timer/Counter for Control Applications (TCC). Each SAMD21 has multiple copies of each, called 'instances'.

Each TC instance has one count register, one control register, and two output channels. Either channel can be enabled and disabled, and either channel can be inverted. The pins connected to a TC instance can output identical versions of the same PWM waveform, or complementary waveforms.

Each TCC instance has a single count register, but multiple compare registers and output channels. There are options for different kinds of waveform, interleaved switching, programmable dead time, and so on.

The biggest members of the SAMD21 family have five TC instances with two 'waveform output' (WO) channels, and three TCC instances with eight WO channels:

- TC[0-4],WO[0-1]
- TCC[0-2],WO[0-7]

And those are the ones shown in the datasheet's multiplexer tables.

The SAMD21G used in the Feather M0 only has three TC instances with two output channels, and three TCC instances with eight output channels:

- TC[3-5],WO[0-1]
- TCC[0-2],WO[0-7]

Tracing the signals to the pins broken out on the Feather M0, the following pins can't do PWM at all:

- Analog pin A5

The following pins can be configured for PWM without any signal conflicts as long as the SPI, I2C, and UART pins keep their protocol functions:

- Digital pins 5, 6, 9, 10, 11, 12, and 13
- Analog pins A3 and A4

If only the SPI pins keep their protocol functions, you can also do PWM on the following pins:

- TX and SDA (Digital pins 1 and 20)

analogWrite() PWM range

On AVR, if you set a pin's PWM with `analogWrite(pin, 255)` it will turn the pin fully HIGH. On the ARM cortex, it will set it to be 255/256 so there will be very slim but

still-existing pulses-to-0V. If you need the pin to be fully on, add test code that checks if you are trying to `analogWrite(pin, 255)` and, instead, does a `digitalWrite(pin, HIGH)`

analogWrite() DAC on A0

If you are trying to use `analogWrite()` to control the DAC output on A0, make sure you do not have a line that sets the pin to output. Remove: `pinMode(A0, OUTPUT)`.

Missing header files

There might be code that uses libraries that are not supported by the M0 core. For example if you have a line with

```
#include <util/delay.h>
```

you'll get an error that says

```
fatal error: util/delay.h: No such file or directory
#include <util/delay.h>
^
compilation terminated.
Error compiling.
```

In which case you can simply locate where the line is (the error will give you the file name and line number) and 'wrap it' with `#ifdef`'s so it looks like:

```
#if !defined(ARDUINO_ARCH_SAM) && !defined(ARDUINO_ARCH_SAMD) && !
defined(ESP8266) && !defined(ARDUINO_ARCH_STM32F2)
#include <util/delay.h>
#endif
```

The above will also make sure that header file isn't included for other architectures

If the `#include` is in the arduino sketch itself, you can try just removing the line.

Bootloader Launching

For most other AVR's, clicking reset while plugged into USB will launch the bootloader manually, the bootloader will time out after a few seconds. For the M0/M4, you'll need

to double click the button. You will see a pulsing red LED to let you know you're in bootloader mode. Once in that mode, it wont time out! Click reset again if you want to go back to launching code.

Aligned Memory Access

This is a little less likely to happen to you but it happened to me! If you're used to 8-bit platforms, you can do this nice thing where you can typecast variables around. e.g.

```
uint8_t mybuffer[4];  
float f = (float)mybuffer;
```

You can't be guaranteed that this will work on a 32-bit platform because mybuffer might not be aligned to a 2 or 4-byte boundary. The ARM Cortex-M0 can only directly access data on 16-bit boundaries (every 2 or 4 bytes). Trying to access an odd-boundary byte (on a 1 or 3 byte location) will cause a Hard Fault and stop the MCU. Thankfully, there's an easy work around ... just use memcpy!

```
uint8_t mybuffer[4];  
float f;  
memcpy(&f, mybuffer, 4)
```

Floating Point Conversion

Like the AVR Arduinos, the M0 library does not have full support for converting floating point numbers to ASCII strings. Functions like sprintf will not convert floating point. Fortunately, the standard AVR-LIBC library includes the dtostrf function which can handle the conversion for you.

Unfortunately, the M0 run-time library does not have dtostrf. You may see some references to using #include <avr/dtostrf.h> to get dtostrf in your code. And while it will compile, it does not work.

Instead, check out this thread to find a working dtostrf function you can include in your code:

<http://forum.arduino.cc/index.php?topic=368720.0> (<https://adafru.it/IFS>)

How Much RAM Available?

The ATSAM21G18 has 32K of RAM, but you still might need to track it for some reason. You can do so with this handy function:

```
extern "C" char *sbrk(int i);

int FreeRam () {
  char stack_dummy = 0;
  return &stack_dummy - sbrk(0);
}
```

Thx to <http://forum.arduino.cc/index.php?topic=365830.msg2542879#msg2542879> (<https://adafru.it/m6D>) for the tip!

Storing data in FLASH

If you're used to AVR, you've probably used `PROGMEM` to let the compiler know you'd like to put a variable or string in flash memory to save on RAM. On the ARM, it's a little easier, simply add `const` before the variable name:

```
const char str[] = "My very long string";
```

That string is now in FLASH. You can manipulate the string just like RAM data, the compiler will automatically read from FLASH so you don't need special `progmem`-knowledgeable functions.

You can verify where data is stored by printing out the address:
`Serial.print("Address of str $"); Serial.println((int)&str, HEX);`

If the address is `$2000000` or larger, it's in SRAM. If the address is between `$0000` and `$3FFFF` Then it is in FLASH

Pretty-Printing out registers

There's a lot of registers on the SAMD21, and you often are going through ASF or another framework to get to them. So having a way to see exactly what's going on is handy. This library from drewfish will help a ton!

<https://github.com/drewfish/arduino-ZeroRegs> (<https://adafru.it/Bet>)

M4 Performance Options

As of version 1.4.0 of the Adafruit SAMD Boards package in the Arduino Boards Manager, some options are available to wring extra performance out of M4-based devices. These are in the Tools menu.

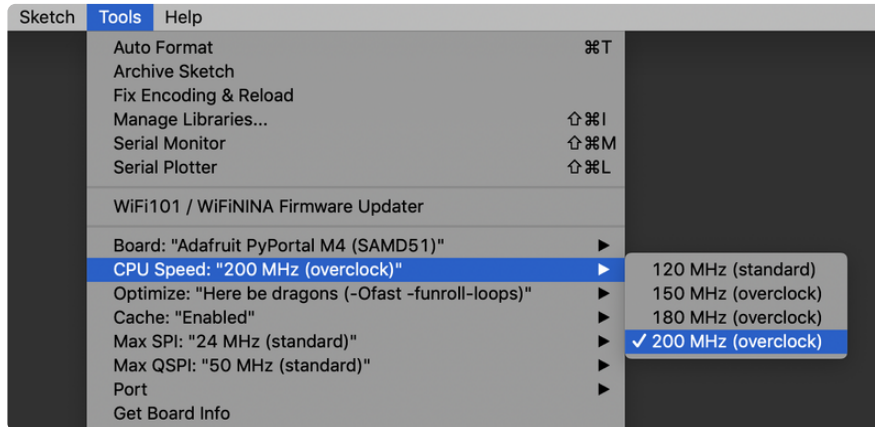

All of these performance tweaks involve a degree of uncertainty. There's no guarantee of improved performance in any given project, and some may even be detrimental, failing to work in part or in whole. If you encounter trouble, select the default performance settings and re-upload.

Here's what you get and some issues you might encounter...

CPU Speed (overclocking)

This option lets you adjust the microcontroller core clock...the speed at which it processes instructions...beyond the official datasheet specifications.

Manufacturers often rate speeds conservatively because such devices are marketed for harsh industrial environments...if a system crashes, someone could lose a limb or worse. But most creative tasks are less critical and operate in more comfortable settings, and we can push things a bit if we want more speed.

There is a small but nonzero chance of code locking up or failing to run entirely. If this happens, try dialing back the speed by one notch and re-upload, see if it's more stable.

Much more likely, some code or libraries may not play well with the nonstandard CPU speed. For example, currently the NeoPixel library assumes a 120 MHz CPU speed and won't issue the correct data at other settings (this will be worked on). Other

libraries may exhibit similar problems, usually anything that strictly depends on CPU timing...you might encounter problems with audio- or servo-related code depending how it's written. If you encounter such code or libraries, set the CPU speed to the default 120 MHz and re-upload.

Optimize

There's usually more than one way to solve a problem, some more resource-intensive than others. Since Arduino got its start on resource-limited AVR microcontrollers, the C++ compiler has always aimed for the smallest compiled program size. The "Optimize" menu gives some choices for the compiler to take different and often faster approaches, at the expense of slightly larger program size...with the huge flash memory capacity of M4 devices, that's rarely a problem now.

The "Small" setting will compile your code like it always has in the past, aiming for the smallest compiled program size.

The "Fast" setting invokes various speed optimizations. The resulting program should produce the same results, is slightly larger, and usually (but not always) noticeably faster. It's worth a shot!

"Here be dragons" invokes some more intensive optimizations...code will be larger still, faster still, but there's a possibility these optimizations could cause unexpected behaviors. Some code may not work the same as before. Hence the name. Maybe you'll discover treasure here, or maybe you'll sail right off the edge of the world.

Most code and libraries will continue to function regardless of the optimizer settings. If you do encounter problems, dial it back one notch and re-upload.

Cache

This option allows a small collection of instructions and data to be accessed more quickly than from flash memory, boosting performance. It's enabled by default and should work fine with all code and libraries. But if you encounter some esoteric situation, the cache can be disabled, then recompile and upload.

Max SPI and Max QSPI

These should probably be left at their defaults. They're present mostly for our own experiments and can cause serious headaches.

Max SPI determines the clock source for the M4's SPI peripherals. Under normal circumstances this allows transfers up to 24 MHz, and should usually be left at that setting. But...if you're using write-only SPI devices (such as TFT or OLED displays), this option lets you drive them faster (we've successfully used 60 MHz with some TFT screens). The caveat is, if using any read/write devices (such as an SD card), this will not work at all...SPI reads absolutely max out at the default 24 MHz setting, and anything else will fail. Write = OK. Read = FAIL. This is true even if your code is using a lower bitrate setting...just having the different clock source prevents SPI reads.

Max QSPI does similarly for the extra flash storage on M4 "Express" boards. Very few Arduino sketches access this storage at all, let alone in a bandwidth-constrained context, so this will benefit next to nobody. Additionally, due to the way clock dividers are selected, this will only provide some benefit when certain "CPU Speed" settings are active. Our [PyPortal Animated GIF Display \(https://adafru.it/EkO\)](https://adafru.it/EkO) runs marginally better with it, if using the QSPI flash.

Enabling the Buck Converter on some M4 Boards

If you want to reduce power draw, some of our boards have an inductor so you can use the 1.8V buck converter instead of the built in linear regulator. If the board does have an inductor (see the schematic) you can add the line `SUPC->VREG.bit.SEL = 1;` to your code to switch to it. Note it will make ADC/DAC reads a bit noisier so we don't use it by default. [You'll save ~4mA \(https://adafru.it/FOH\)](https://adafru.it/FOH).

Downloads

Datasheets & Files

- [Atmel Software Programming guide for WINC1500 \(https://adafru.it/ldD\)](https://adafru.it/ldD) - this is for the underlying ASF codebase that is 'wrapped' in Adafruit_WINC1500 but its still very handy reference
- [ATSAMD21 Datasheet \(https://adafru.it/ldE\)](https://adafru.it/ldE) - Its long, but its a good read
- [EagleCAD PCB Files on GitHub \(https://adafru.it/oeK\)](https://adafru.it/oeK)

Adafruit Feather M0 WiFi Pinout
Diagram

<https://adafru.it/z4e>

Note AREF in the diagram should be marked PA03 not PA02

Schematic

Click to enlarge

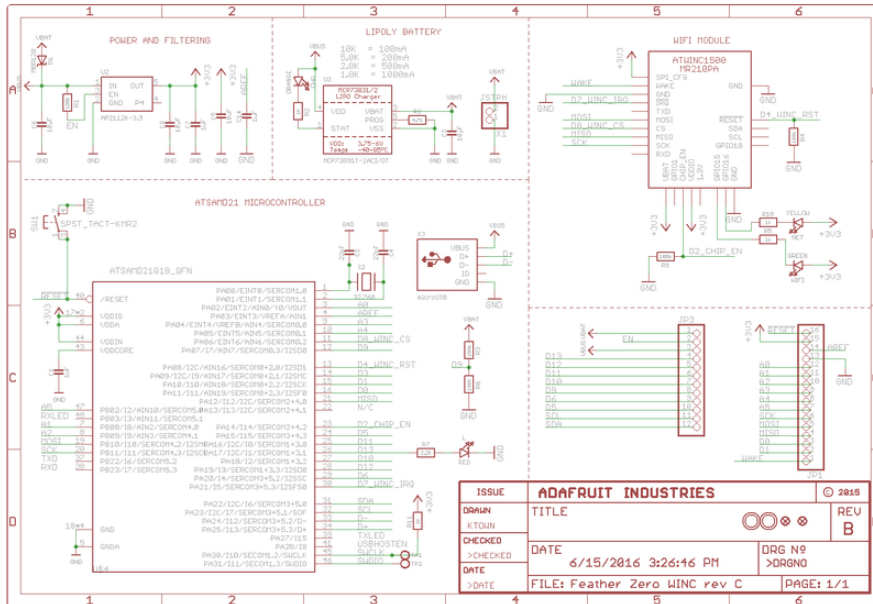

Fabrication Print

Dimensions in inches

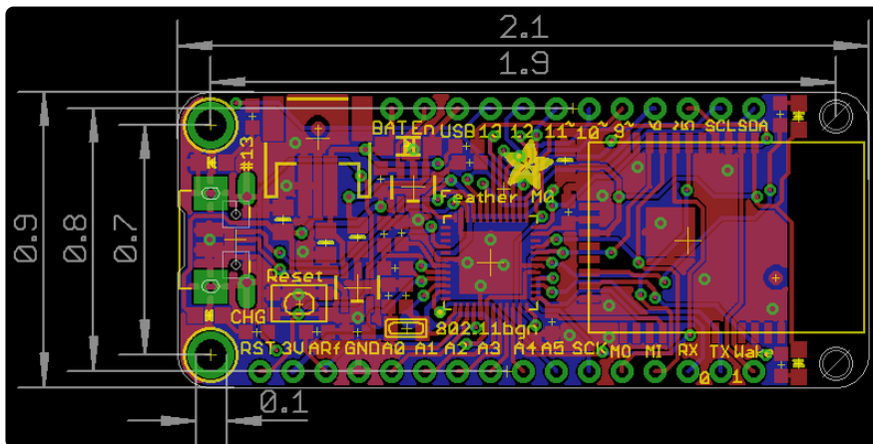

Feather HELP!

Even though this FAQ is labeled for Feather, the questions apply to ItsyBitsy's as well!

My ItsyBitsy/Feather stopped working when I unplugged the USB!

A lot of our example sketches have a

```
while (!Serial);
```

line in setup(), to keep the board waiting until the USB is opened. This makes it a lot easier to debug a program because you get to see all the USB data output. If you want to run your Feather without USB connectivity, delete or comment out that line

My Feather never shows up as a COM or Serial port in the Arduino IDE

A vast number of Itsy/Feather 'failures' are due to charge-only USB cables

We get upwards of 5 complaints a day that turn out to be due to charge-only cables!

Use only a cable that you know is for data syncing

If you have any charge-only cables, cut them in half throw them out. We are serious! They tend to be low quality in general, and will only confuse you and others later, just get a good data+charge USB cable.

A quality USB port is critical. Avoid plugging into USB keyboards and when possible use a USB-2 HUB to avoid USB3 issues.

Ack! I "did something" and now when I plug in the Itsy/Feather, it doesn't show up as a device anymore so I cant upload to it or fix it...

No problem! You can 'repair' a bad code upload easily. Note that this can happen if you set a watchdog timer or sleep mode that stops USB, or any sketch that 'crashes' your board

1. Turn on verbose upload in the Arduino IDE preferences
2. Plug in Itsy or Feather 32u4/M0, it won't show up as a COM/serial port that's ok
3. Open up the Blink example (Examples->Basics->Blink)

4. Select the correct board in the Tools menu, e.g. Feather 32u4, Feather M0, Itsy 32u4 or M0 (physically check your board to make sure you have the right one selected!)
5. Compile it (make sure that works)
6. Click Upload to attempt to upload the code
7. The IDE will print out a bunch of COM Ports as it tries to upload. During this time, double-click the reset button, you'll see the red pulsing LED that tells you its now in bootloading mode
8. The board will show up as the Bootloader COM/Serial port
9. The IDE should see the bootloader COM/Serial port and upload properly

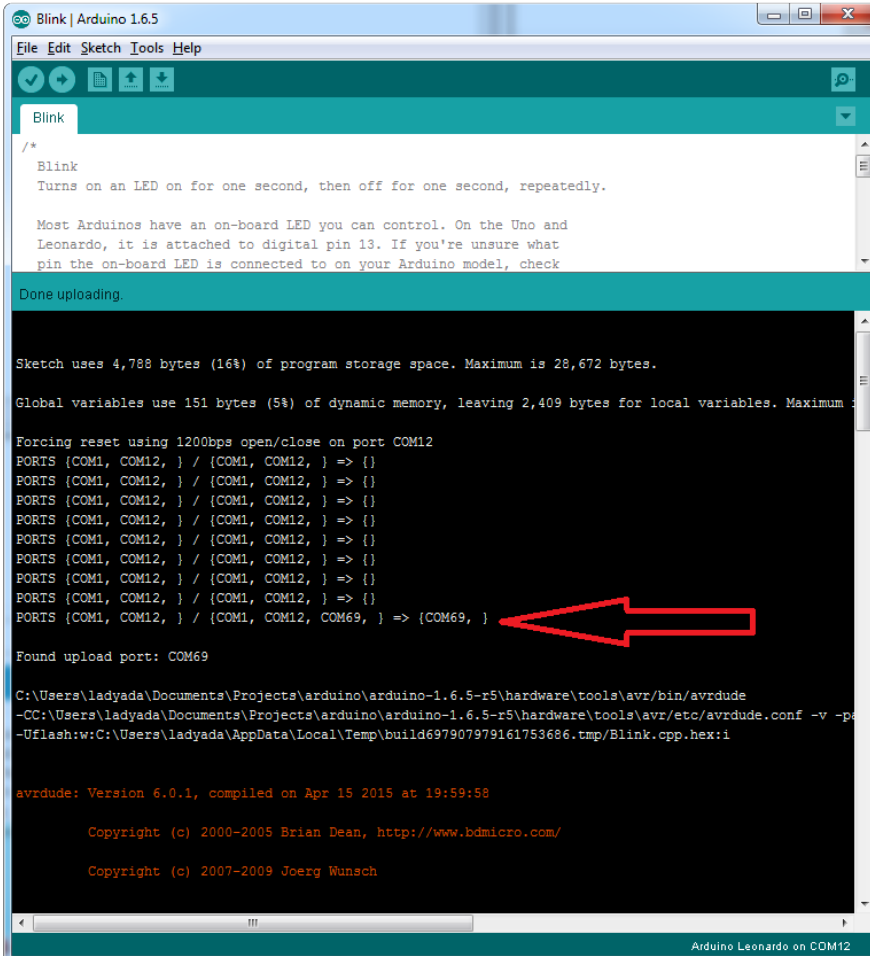

```
Blink | Arduino 1.6.5
File Edit Sketch Tools Help
Blink
/*
  Blink
  Turns on an LED on for one second, then off for one second, repeatedly.

  Most Arduinos have an on-board LED you can control. On the Uno and
  Leonardo, it is attached to digital pin 13. If you're unsure what
  pin the on-board LED is connected to on your Arduino model, check
  the pin configuration file.

  See: http://www.arduino.cc/en/tutorial/blink

  Created: 2010
  Author: Arduino.cc
  Modified: 2014
  Version: 1.0
*/

const int LED_PIN = 13;

void setup() {
  pinMode(LED_PIN, OUTPUT);
}

void loop() {
  digitalWrite(LED_PIN, HIGH);   // turn the LED on (HIGH is the positive lead)
  delay(1000);                  // wait for a second
  digitalWrite(LED_PIN, LOW);    // turn the LED off by making the pin LOW
  delay(1000);                  // wait for a second
}

Done uploading.

Sketch uses 4,788 bytes (16%) of program storage space. Maximum is 28,672 bytes.
Global variables use 151 bytes (5%) of dynamic memory, leaving 2,409 bytes for local variables. Maximum is 2048 bytes.

Forcing reset using 1200bps open/close on port COM12
PORTS {COM1, COM12, } / {COM1, COM12, } => {}
PORTS {COM1, COM12, } / {COM1, COM12, } => {}
PORTS {COM1, COM12, } / {COM1, COM12, } => {}
PORTS {COM1, COM12, } / {COM1, COM12, } => {}
PORTS {COM1, COM12, } / {COM1, COM12, } => {}
PORTS {COM1, COM12, } / {COM1, COM12, } => {}
PORTS {COM1, COM12, } / {COM1, COM12, } => {}
PORTS {COM1, COM12, } / {COM1, COM12, } => {}
PORTS {COM1, COM12, } / {COM1, COM12, } => {}
PORTS {COM1, COM12, } / {COM1, COM12, COM69, } => {COM69, }
Found upload port: COM69

C:\Users\ladyada\Documents\Projects\arduino\arduino-1.6.5-r5\hardware\tools\avr\bin\avrdude
-CC:\Users\ladyada\Documents\Projects\arduino\arduino-1.6.5-r5\hardware\tools\avr\etc\avrdude.conf -v -p
-Uflash:w:C:\Users\ladyada\AppData\Local\Temp\build697907979161753686.tmp\Blink.cpp.hex:i

avrdude: Version 6.0.1, compiled on Apr 15 2015 at 19:59:58

Copyright (c) 2000-2005 Brian Dean, http://www.bdmicro.com/

Copyright (c) 2007-2009 Joerg Wunsch

Arduino Leonardo on COM12
```

I can't get the Itsy/Feather USB device to show up - I get "USB Device Malfunctioning" errors!

This seems to happen: when people select the wrong board from the Arduino Boards menu.

If you have a Feather 32u4 (look on the board to read what it is you have) Make sure you select Feather 32u4 for ATmega32u4 based boards! Do not use anything else, do not use the 32u4 breakout board line.

If you have a Feather M0 (look on the board to read what it is you have) Make sure you select Feather M0 - do not use 32u4 or Arduino Zero

If you have a ItsyBitsy M0 (look on the board to read what it is you have) Make sure you select ItsyBitsy M0 - do not use 32u4 or Arduino Zero

I'm having problems with COM ports and my Itsy/Feather 32u4/M0

There's two COM ports you can have with the 32u4/M0, one is the user port and one is the bootloader port. They are not the same COM port number!

When you upload a new user program it will come up with a user com port, particularly if you use Serial in your user program.

If you crash your user program, or have a program that halts or otherwise fails, the user COM port can disappear.

When the user COM port disappears, Arduino will not be able to automatically start the bootloader and upload new software.

So you will need to help it by performing the click-during upload procedure to restart the bootloader, and upload something that is known working like "Blink"

I don't understand why the COM port disappears, this does not happen on my Arduino UNO!

UNO-type Arduinos have a separate serial port chip (aka "FTDI chip" or "Prolific PL2303" etc etc) which handles all serial port capability separately than the main chip. This way if the main chip fails, you can always use the COM port.

M0 and 32u4-based Arduinos do not have a separate chip, instead the main processor performs this task for you. It allows for a lower cost, higher power setup...but requires a little more effort since you will need to 'kick' into the bootloader manually once in a while

I'm trying to upload to my 32u4, getting "avrdude: butterfly_recv(): programmer is not responding" errors

This is likely because the bootloader is not kicking in and you are accidentally trying to upload to the wrong COM port

The best solution is what is detailed above: manually upload Blink or a similar working sketch by hand by manually launching the bootloader

I'm trying to upload to my Feather M0, and I get this error "Connecting to programmer: .avrdude: butterfly_recv(): programmer is not responding"

You probably don't have Feather M0 selected in the boards drop-down. Make sure you selected Feather M0.

I'm trying to upload to my Feather and i get this error "avrdude: ser_recv(): programmer is not responding"

You probably don't have Feather M0 / Feather 32u4 selected in the boards drop-down. Make sure you selected Feather M0 (or Feather 32u4).

I attached some wings to my Feather and now I can't read the battery voltage!

Make sure your Wing doesn't use pin #9 which is the analog sense for the lipo battery!

The yellow LED Is flickering on my Feather, but no battery is plugged in, why is that?

The charge LED is automatically driven by the Lipoly charger circuit. It will try to detect a battery and is expecting one to be attached. If there isn't one it may flicker once in a while when you use power because it's trying to charge a (non-existent) battery.

It's not harmful, and its totally normal!

The Arduino IDE gives me "Device Descriptor Request Failed"

This can require "manual bootloading".

If you ever get in a 'weird' spot with the bootloader, or you have uploaded code that crashes and doesn't auto-reboot into the bootloader, double-click the RST button to get back into the bootloader. The red LED will pulse, so you know that its in bootloader mode. Do the reset button double-press right as the Arduino IDE says its attempting to upload the sketch, when you see the Yellow Arrow lit and the Uploading... text in the status bar.

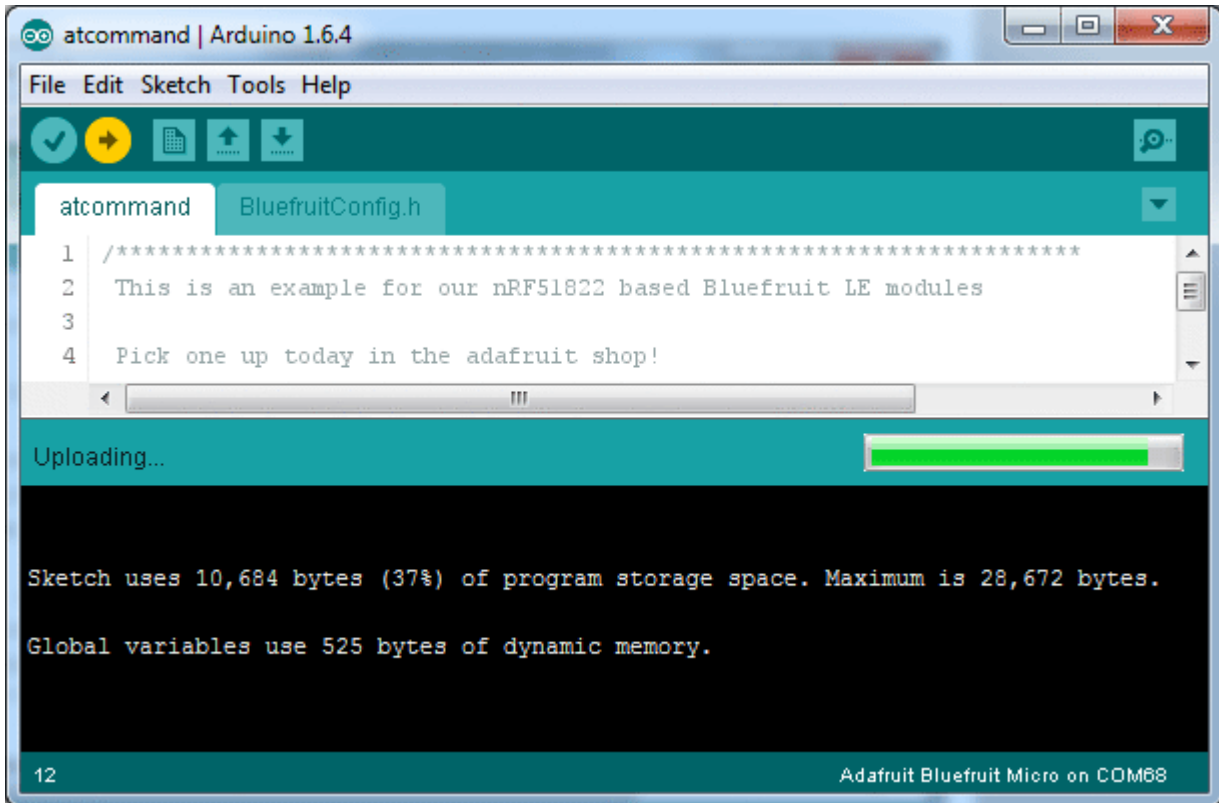

<https://adafru.it/UJA>

Don't click the reset button before uploading, unlike other bootloaders you want this one to run at the time Arduino is trying to upload

Mouser Electronics

Authorized Distributor

Click to View Pricing, Inventory, Delivery & Lifecycle Information:

[Adafruit:](#)

[3010](#) [3061](#) [3044](#) [2598](#) [3031](#)