

MODEL LD - LARGE DISPLAY TIMER AND CYCLE COUNTER



- 2.25" or 4" HIGH RED LED DIGITS
- 6-DIGIT BI-DIRECTIONAL TIMING CAPABILITY
- 5-DIGIT CYCLE COUNTING CAPABILITY
- SELECTABLE TIMER RANGES AND OPERATING MODES
- ELAPSED TIMER AND PRESET TIMER FUNCTIONALITY
- SERIAL COMMUNICATIONS (RS232 or RS485)
- PROGRAMMABLE USER INPUT
- UNIVERSALLY POWERED
- 5 AMP FORM C RELAY OUTPUT
- ALUMINUM NEMA 4X CASE CONSTRUCTION

GENERAL DESCRIPTION

The Large Display Timer and Cycle Counter is a versatile display that functions as an Elapsed Timer or Preset Timer, with full-featured user programmability. The meter includes a built-in Cycle Counter, relay output and serial communications capability. The 6 digit displays are available in either 2.25" or 4" high red LED digits with adjustable display intensity. The 2.25" high models are readable up to 130 feet. The 4" high models are readable up to 180 feet. Both versions are constructed of a NEMA 4X/IP65 enclosure in light weight aluminum.

The Timer has two signal inputs and eight input operating modes. These modes provide level active or edge triggered start/stop operation. The Timer features 18 selectable timer ranges to cover a wide variety of timing applications. The built-in Cycle Counter can be linked to timer operation to count timing cycles, or function as a totally independent counter, accepting count speeds up to 500 Hz. The display can be toggled either manually or automatically between the Timer and Counter values.

In addition to the Timer/Counter inputs, a programmable User Input is provided to perform a variety of meter functions. DIP switches are used to configure the inputs for current sinking (active low) or current sourcing (active high) operation.

The Setpoint Output can be assigned to the Timer or Counter value, and configured to suit a variety of control and alarm requirements. The meter also includes RS232 or RS485 serial communications.

SAFETY SUMMARY

All safety regulations, local codes and instructions that appear in this and corresponding literature, or on equipment, must be observed to ensure personal safety and to prevent damage to either the instrument or equipment connected to it. If equipment is used in a manner not specified by the manufacturer, the protection provided by the equipment may be impaired.

Do not use this unit to directly command motors, valves, or other actuators not equipped with safeguards. To do so can be potentially harmful to persons or equipment in the event of a fault to the unit.



The protective conductor terminal is bonded to conductive parts of the equipment for safety purposes and must be connected to an external protective earthing system.

SPECIFICATIONS

1. **DISPLAY:** 2.25" (57 mm) or 4" (101 mm) intensity adjustable Red LED
2. **POWER REQUIREMENTS:**
 AC POWER: 50 to 250 VAC 50/60 Hz, 26 VA
 DC POWER: 21.6 to 250 VDC, 11 W
 DC Out: +24 VDC @ 100 mA if input voltage is greater than 50 VAC/VDC
 +24 VDC @ 50 mA if input voltage is less than 50 VDC
 Isolation: 2300 V_{RMS} for 1 min. to all inputs and outputs
3. **TIMER DISPLAY:** 6-digits
 Display Range: 0 to 999999
 Overflow/Underflow Indication: Display flashes "E OUEr"
 Minimum Digit Resolution: 0.001 Sec.
 Maximum Single Digit Resolution: 1 Hr.
 Timing Accuracy: ±0.01%
4. **CYCLE COUNTER DISPLAY:** 5-digits, may be disabled if not used
 Display Designator: "E" to the left side of the display
 Display Range: 0 to 99999
 Overflow/Underflow Indication: Display flashes "E OUEr"

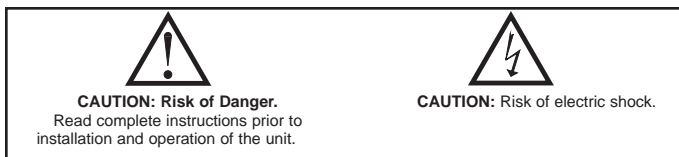

DIMENSIONS In inches (mm)

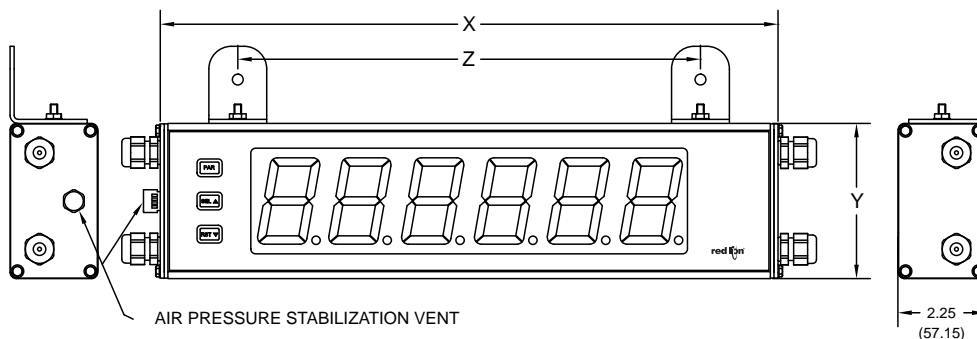

PART NUMBER	X (Length)	Y (Height)	Z (Center)
LD2T06P0	16 (406.4)	4 (101.6)	12 (304.8)
LD4T06P0	26 (660.4)	7.875 (200)	22 (558.8)

Maximum Count Rate:

All Count Sources except Input B: 10 Hz

Input B Count Source:

With Timer Input Filter ON: 10 Hz

With Timer Input Filter OFF: 500 Hz

5. TIMER SIGNAL INPUTS (INP A and INP B)

DIP switch selectable pull-up (7.8 KΩ) or pull-down (3.9 KΩ) resistors determine active high or active low input logic.

Input A Trigger levels: $V_{IL} = 1.25$ V max; $V_{IH} = 2.75$ V min; $V_{MAX} = 28$ VDC

Input B: Trigger levels: $V_{IL} = 1.0$ V max; $V_{IH} = 2.4$ V min; $V_{MAX} = 28$ VDC

Inputs A and B:

Timer Input Pulse Width: 1 msec min.

Timer Start/Stop Response Time: 1 msec max.

Filter: Software filtering provided for relay or switch contact debounce.

Filter enabled or disabled through programming. If enabled, results in 50 msec start/stop response time for successive pulses applied to the same input terminal.

6. RESET/USER INPUT Programmable Function Input:

DIP switch selectable pull-up (7.8 KΩ) or pull-down (3.9 KΩ) resistor that determines active high or active low input logic.

Trigger levels: $V_{IL} = 1.0$ V max; $V_{IH} = 2.4$ V min; $V_{MAX} = 28$ VDC

Response Time: 10 msec typ.; 50 msec debounce (activation and release)

7. COMMUNICATIONS:

RS485 SERIAL COMMUNICATIONS

Type: RS485 multi-point balanced interface (isolated)

Baud Rate: 300 to 38400

Data Format: 7/8 bits; odd, even, or no parity

Bus Address: 0 to 99; max 32 meters per line

RS232 SERIAL COMMUNICATIONS

Type: RS232 half duplex (isolated)

Baud Rate: 300 to 38400

Data Format: 7/8 bits; odd, even, or no parity

8. MEMORY: Nonvolatile E²PROM retains all programming parameters and timer/count values when power is removed.

9. OUTPUT:

Relay: Form C contacts rated at 5 amps @ 120/240 VAC or 28 VDC (resistive load), 1/8 H.P. @ 120 VAC (inductive load)

10. CONNECTIONS:

Internal removable terminal blocks are used for power and signal wiring. Remove end plates with 1/4" nut driver. For LD4 versions, all wiring is on right side of unit. For LD2 versions, power and signal wiring connections are on the right side and the relay and serial output options are on left side.

Wire Strip Length: 0.4" (10 mm)

Wire Gauge: 24-12 AWG copper wire, 90°C rated insulation only

Torque: 5.3 inch-lbs (0.6 N-m) max

Cable Diameter: Outside diameter must be 0.181" (4.6 mm) to 0.312" (7.9 mm) to maintain NEMA 4 rating of cord grips.

11. ENVIRONMENTAL CONDITIONS:

Operating temperature: 0 to 65 °C

Storage temperature: -40 to 70 °C

Operating and storage humidity: 0 to 85% max. RH (non-condensing)

Vibration According to IEC 68-2-6: Operational 5 to 150 Hz, in X, Y, Z direction for 1.5 hours, 2 g's (1g relay).

Shock According to IEC 68-2-27: Operational 30 g's (10g relay), 11 msec in 3 directions.

Altitude: Up to 2,000 meters

12. CERTIFICATIONS AND COMPLIANCES:

SAFETY

UL Listed, File # E137808, UL508, CSA C22.2 No. 14-M95

LISTED by Und. Lab. Inc. to U.S. and Canadian safety standards

Type 4X Enclosure rating, UL50

IEC 61010-1, EN 61010-1: Safety requirements for electrical equipment for measurement, control, and laboratory use, Part 1.

IP65 Enclosure rating, IEC 529

ELECTROMAGNETIC COMPATIBILITY

Emissions and Immunity to EN 61326: Electrical Equipment for Measurement, Control and Laboratory use.

Immunity to Industrial Locations:

Electrostatic discharge	EN 61000-4-2	Criterion A 4 kV contact discharge 8 kV air discharge
Electromagnetic RF fields	EN 61000-4-3	Criterion A 10 V/m
Fast transients (burst)	EN 61000-4-4	Criterion A 2 kV power 1 kV signal
Surge	EN 61000-4-5	Criterion A 1 kV L-L, 2 kV L&N-E power
RF conducted interference	EN 61000-4-6	Criterion A 3 V/rms
Voltage dip/interruptions	EN61000-4-11	Criterion A 0.5 cycle

Emissions:

Emissions	EN 55011	Class B
-----------	----------	---------

Notes:

1. Criterion A: Normal operation within specified limits.

13. CONSTRUCTION: Aluminum enclosure, and steel side panels with textured black polyurethane paint for scratch and corrosion resistance protection. Meets NEMA 4X/IP65 specifications. Installation Category II, Pollution Degree 2.

14. WEIGHT:

LD2T06P0 - 4.5 lbs (2.04 kg)

LD4T06P0 - 10.5 lbs (4.76 kg)

ORDERING INFORMATION

MODEL NO.	DESCRIPTION	PART NUMBER
LD	2.25" High 6-Digit Red LED Timer/Cycle Counter w/ Relay Output & RS232/RS485 Serial Communications	LD2T06P0
	4" High 6-Digit Red LED Timer/Cycle Counter w/ Relay Output & RS232/RS485 Serial Communications	LD4T06P0
LD Plug	Panel Meter Plug for LD models	LDPLUG00

1.0 INSTALLING THE METER

INSTALLATION

The meter meets NEMA 4X/IP65 requirements when properly installed.

INSTALLATION ENVIRONMENT

The unit should be installed in a location that does not exceed the operating temperature. Placing the unit near devices that generate excessive heat should be avoided. The unit should only be cleaned with a soft cloth and neutral soap product. Do NOT use solvents.

Continuous exposure to direct sunlight may accelerate the aging process of the front overlay. Do not use tools of any kind (screwdrivers, pens, pencils, etc.) to operate the keypad of the unit.

MOUNTING INSTRUCTIONS

This display is designed to be wall mounted or suspended from a ceiling truss or other suitable structure capable of supporting the LDT. Caution should be exercised when hanging the display to provide for the safety of personnel. If hanging the LDT, run the suspension cables (or chains) through the mounting bracket holes. For wall mounting use #10-32 size bolts.

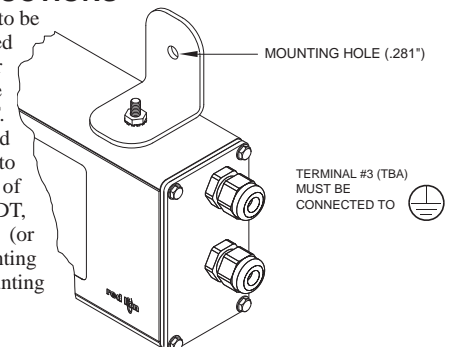

2.0 SETTING THE DIP SWITCHES

To access the switches, remove the right side plate of the meter. A bank of eight switches is located inside the unit. *Note: Some switches are not used and should remain in the factory set position.*



Warning: Exposed line voltage exists on the circuit boards. Remove all power to the meter and load circuits before accessing inside of the meter.

SWITCH 1 (Unused)

This switch is not used and should remain in the factory set position.

SWITCH 2 (Input A) {See Note 1}

SNK: Adds internal 7.8 K Ω pull-up resistor to +12 VDC, $I_{MAX} = 2.1$ mA.
SRC: Adds internal 3.9 K Ω pull-down resistor, 7.2 mA max. @ 28 VDC max.

SWITCH 3 (Input A)

FILTER ON: Provides hardware debounce for Input A to allow relay or switch contacts to be used as a signal source. Software debounce for Inputs A and B is provided in the programming menu (Module 1).

SWITCH 4 (Input B) {See Note 1}

SNK: Adds internal 7.8 K Ω pull-up resistor to +12 VDC, $I_{MAX} = 2.1$ mA.
SRC: Adds internal 3.9 K Ω pull-down resistor, 7.2 mA max. @ 28 VDC max.

SWITCH 5 (Input B)

FILTER ON: Provides hardware debounce for Input B to allow relay or switch contacts to be used as a signal source. Software debounce for Inputs A and B is provided in the programming menu (Module 1).

SWITCH 6 (RESET/USER INPUT) {See Note 1}

SNK: Adds internal 7.8 K Ω pull-up resistor to +12VDC, $I_{MAX} = 2.1$ mA.
SRC: Adds internal 3.9 K Ω pull-down resistor, 7.2 mA max. @ 28 VDC max.

SWITCH 7 (Unused)

This switch is not used and should remain in the factory set position.

SWITCH 8 (Input B)

NORMAL: Input B performs the normal functions described in the Timer Input Operation parameter of the programming menu (Module 1).

INTENSITY ADJUST: In this position, Input B is used to adjust the LED display intensity. Five distinct LED levels can be set by pulsing Input B. The display intensity level can also be set in the programming menu (Module 3).

Note 1: When the DIP switch is in the SNK position (OFF), the input is configured as active low. When the switch is in the SRC position (ON), the input is configured as active high.

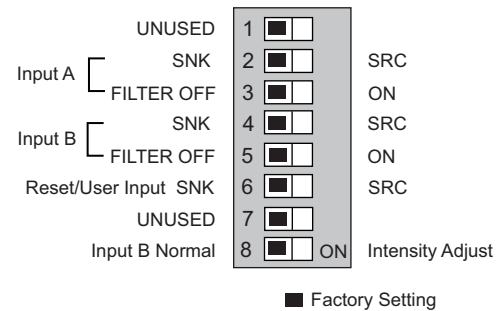

3.0 WIRING THE METER

EMC INSTALLATION GUIDELINES

Although this meter is designed with a high degree of immunity to Electro-Magnetic Interference (EMI), proper installation and wiring methods must be followed to ensure compatibility in each application. The type of the electrical noise, source or coupling method into the meter may be different for various installations. The meter becomes more immune to EMI with fewer I/O connections. Cable length, routing, and shield termination are very important and can mean the difference between a successful or troublesome installation. Listed below are some EMC guidelines for successful installation in an industrial environment.

- The meter should be properly connected to protective earth.
- Use shielded (screened) cables for all Signal and Control inputs. The shield (screen) pigtail connection should be made as short as possible. The connection point for the shield depends somewhat upon the application. Listed below are the recommended methods of connecting the shield, in order of their effectiveness.
 - Connect the shield only at the panel where the unit is mounted to earth ground (protective earth).
 - Connect the shield to earth ground at both ends of the cable, usually when the noise source frequency is above 1 MHz.
 - Connect the shield to common of the meter and leave the other end of the shield unconnected and insulated from earth ground.
- Never run Signal or Control cables in the same conduit or raceway with AC power lines, conductors feeding motors, solenoids, SCR controls, and heaters, etc. The cables should be ran in metal conduit that is properly grounded. This is especially useful in applications where cable runs are long and portable two-way radios are used in close proximity or if the installation is near a commercial radio transmitter.

- Signal or Control cables within an enclosure should be routed as far as possible from contactors, control relays, transformers, and other noisy components.
- In extremely high EMI environments, the use of external EMI suppression devices, such as ferrite suppression cores, is effective. Install them on Signal and Control cables as close to the unit as possible. Loop the cable through the core several times or use multiple cores on each cable for additional protection. Install line filters on the power input cable to the unit to suppress power line interference. Install them near the power entry point of the enclosure. The following EMI suppression devices (or equivalent) are recommended:

Ferrite Suppression Cores for signal and control cables:

Fair-Rite # 0443167251 (RLC# FCOR0000)

TDK # ZCAT3035-1330A

Steward # 28B2029-0A0

Line Filters for input power cables:

Schaffner # FN610-1/07 (RLC# LFIL0000)

Schaffner # FN670-1.8/07

Corcom # 1 VR3

Note: Reference manufacturer's instructions when installing a line filter.

- Long cable runs are more susceptible to EMI pickup than short cable runs. Therefore, keep cable runs as short as possible.
- Switching of inductive loads produces high EMI. Use of snubbers across inductive loads suppresses EMI.
 Snubber: RLC# SNUB0000.

WIRING OVERVIEW

Electrical connections are made via pluggable terminal blocks located inside the meter. All conductors should conform to the meter's voltage and current ratings. All cabling should conform to appropriate standards of good installation, local codes and regulations. It is recommended that the power supplied to the meter (DC or AC) be protected by a fuse or circuit breaker. When wiring the meter, compare the numbers on the label on the back of the meter case against those shown in wiring drawings for proper wire position. Strip the wire, leaving approximately 0.4" (10 mm) bare lead exposed (stranded wires should be tinned with solder.) Insert the lead under the correct screw clamp terminal and tighten until the wire is secure. (Pull wire to verify tightness.) Each terminal can accept up to one #14 AWG (2.55 mm) wire, two #18 AWG (1.02 mm), or four #20 AWG (0.61 mm). Use copper conductors only, with insulation rated at 90°C.

WIRING CONNECTIONS

Internal removable terminal blocks are used for power and signal wiring. Access to terminal blocks is through conduit fittings. Remove end plates with 1/4" nut driver. For LD4 versions, all wiring is on right side of unit. For LD2 versions, power and input wiring connections are on the right side and the relay and serial connections are on the left side.

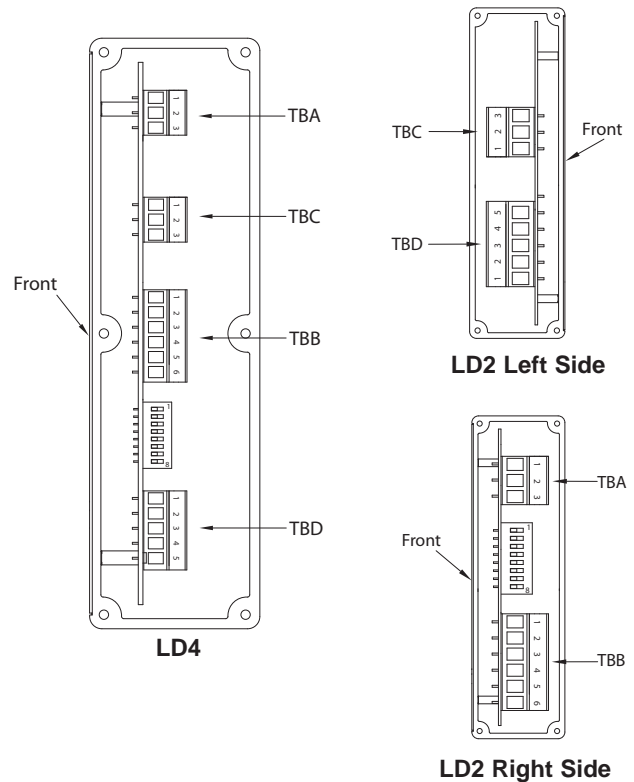

3.1 POWER WIRING

The power wiring is made via the 3 position terminal block (TBA) located inside the unit (right side). The DC out power is located on TBB (right side).

Power

Terminal 1: VAC/DC +
Terminal 2: VAC/DC -
Terminal 3: Protective Conductor Terminal

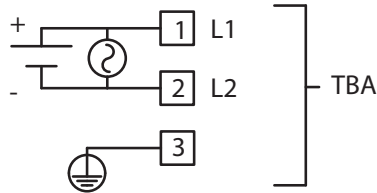

DC Out Power

Terminal 4: + 24 VDC OUT
Terminal 6: User Common

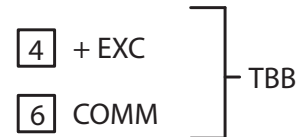

3.2 RESET/USER INPUT WIRING

The Reset/User Input is located on the right side

Terminal 5: Reset/User Input
Terminal 6: User Common

Sinking Logic

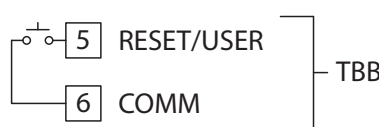

DIP switch 6 OFF

Sourcing Logic



DIP switch 6 ON

3.3 SETPOINT (OUTPUT) WIRING

The setpoint relay uses a three position terminal block (TBC) located on the left side of the LD2 model, and on the right side for the LD4 model.

Terminal 1: Normally Closed
Terminal 2: Normally Open
Terminal 3: Relay Common

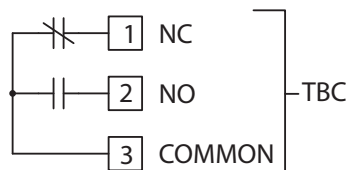

3.4 INPUT WIRING

The Large Display Timer is equipped with two signal inputs, A and B. These inputs are wired using the six position terminal block (TBB) located inside the unit on the right side.

- Terminal 1: Input A
- Terminal 3: Input B
- Terminal 2: Input Common



CAUTION: DC common is NOT isolated from input common. In order to preserve the safety of the meter application, the DC common must be suitably isolated from hazardous live earth referenced voltage; or input common must be at protective earth ground potential. If not, hazardous voltage may be present at the User Input and Input Common terminals. Appropriate considerations must then be given to the potential of the input common with respect to earth ground.

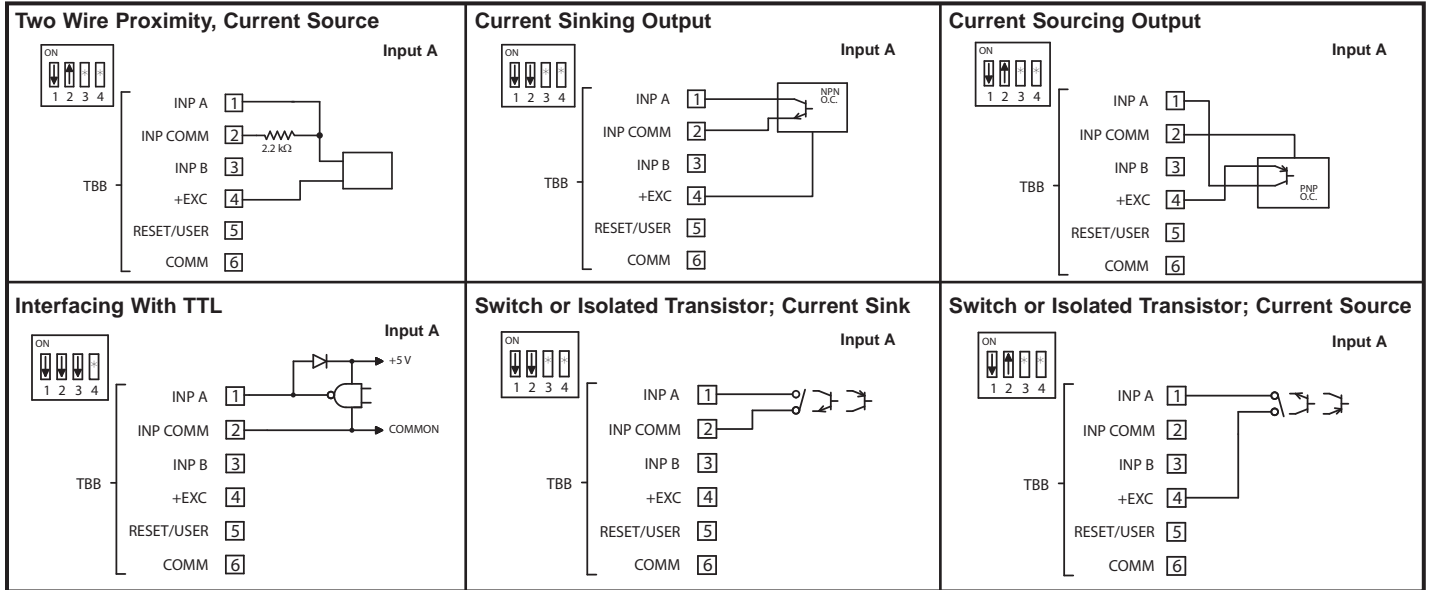

* Switch position is application dependent.

3.5 SERIAL WIRING

The serial connections are made via terminal block TBD located inside the unit on the left side for the LD2 and on the right side for the LD4.

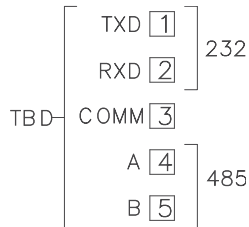

RS485 Communications

The RS485 communication standard allows the connection of up to 32 devices on a single pair of wires, distances up to 4,000 ft. and data rates as high as 10M baud (the LD is limited to 38.4k baud). The same pair of wires is used to both transmit and receive data. RS485 is therefore always half-duplex, that is, data cannot be received and transmitted simultaneously.

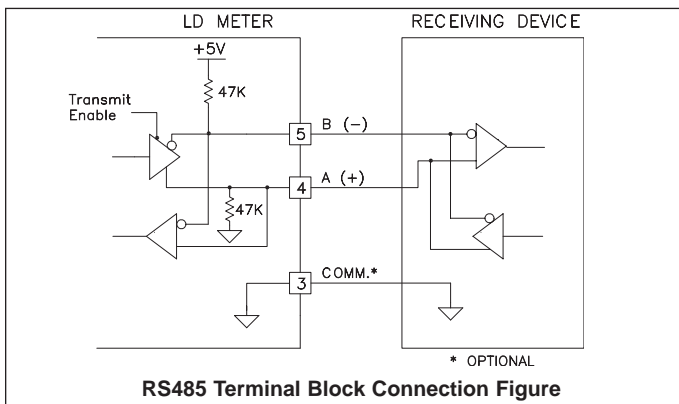

RS232 Communications

RS232 is intended to allow two devices to communicate over distances up to 50 feet. Data Terminal Equipment (DTE) transmits data on the Transmitted Data (TXD) line and receives data on the Received Data (RXD) line. Data Computer Equipment (DCE) receives data on the TXD line and transmits data on the RXD line. The LD emulates a DTE. If the other device connected to the meter also emulates a DTE, the TXD and RXD lines must be interchanged for communications to take place. This is known as a null modem connection. Most printers emulate a DCE device while most computers emulate a DTE device.

Some devices cannot accept more than two or three characters in succession without a pause in between. In these cases, the meter employs a busy function.

As the meter begins to transmit data, the RXD line (RS232) is monitored to determine if the receiving device is "busy". The receiving device asserts that it is busy by setting the RXD line to a space condition (logic 0). The meter then suspends transmission until the RXD line is released by the receiving device.

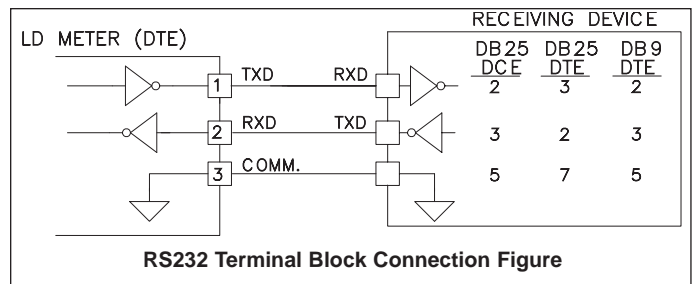

4.0 REVIEWING THE FRONT PANEL KEYS AND DISPLAY



KEY	DISPLAY MODE OPERATION
PAR	Access Programming Mode
SEL▲	Select display (Timer or Cycle Counter)
RST▼	Reset value(s) per front panel reset setting

PROGRAMMING MODE OPERATION
Store selected parameter and index to next parameter
Advance through selection list/select digit position in parameter value
Increment selected digit position of parameter value

OPERATING MODE DISPLAY DESIGNATORS

“**L**” - To the left of the display is the Cycle Counter value.
 “ **f** ” - Between digits 5 and 6 indicates the setpoint status.

“ . ” - Decimal point to the far right of the display can be programmed to flash when the timer is running, to provide a “Timer Run” indicator.

If display scroll is enabled, the display will toggle automatically every four seconds between the Timer and Cycle Counter values.

5.0 PROGRAMMING THE METER

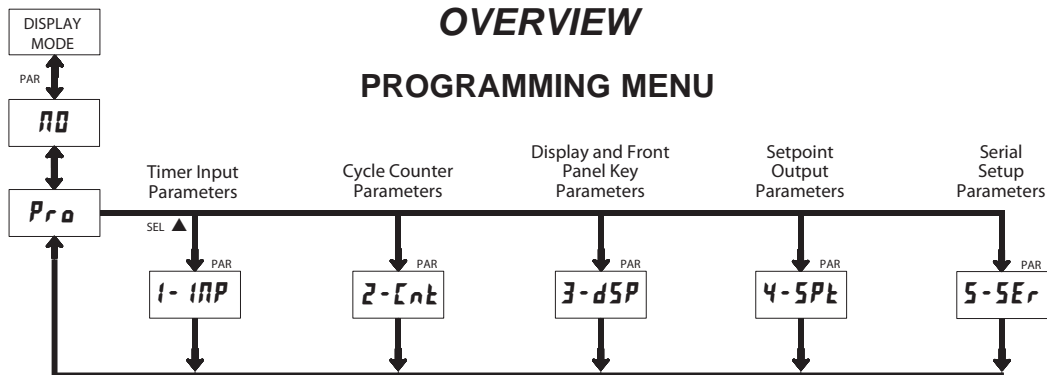

PROGRAMMING MODE ENTRY (PAR KEY)

It is recommended all programming changes be made off line, or before installation. The meter normally operates in the Display Mode. No parameters can be programmed in this mode. The Programming Mode is entered by pressing the **PAR** key. If it is not accessible, then it is locked by either a security code or a hardware lock (See Module 3).

MODULE ENTRY (SEL▲ & PAR KEYS)

The Programming Menu is organized into five modules. These modules group together parameters that are related in function. The display will alternate between **Prd** and the present module. The **SEL▲** key is used to select the desired module. The displayed module is entered by pressing the **PAR** key.

MODULE MENU (PAR KEY)

Each module has a separate module menu (which is shown at the start of each module discussion). The **PAR** key is pressed to advance to a particular parameter to be changed, without changing the programming of preceding parameters. After completing a module, the display will return to **Prd**. Programming may continue by accessing additional modules.

SELECTION / VALUE ENTRY

For each parameter, the display alternates between the present parameter and the selections/value for that parameter. The **SEL▲** and **RST▼** keys are used to move through the selections/values for that parameter. Pressing the **PAR** key, stores and activates the displayed selection/value. This also advances the meter to the next parameter.

For numeric values, the value is displayed with one digit flashing (initially the right most digit). Pressing the **RST▼** key increments the digit by one or the user can hold the **RST▼** key and the digit will automatically scroll. The **SEL▲** key will select the next digit to the left. Pressing the **PAR** key will enter the value and move to the next parameter.

PROGRAMMING MODE EXIT (PAR KEY)

The Programming Mode is exited by pressing the **PAR** key with **Prd** displayed. This will commit any stored parameter changes to memory and return the meter to the Display Mode. (If power loss occurs before returning to the Display Mode, verify recent parameter changes.)

PROGRAMMING TIPS

It is recommended to start with Module 1 and proceed through each module in sequence. When programming is complete, it is recommended to record the parameter programming and lock out parameter programming with the user input or programming security code.

FACTORY SETTINGS

Factory Settings may be completely restored in Module 3. This is useful when encountering programming problems.

ALTERNATING SELECTION DISPLAY

In the explanation of the modules, the following dual display with arrows will appear. This is used to illustrate the display alternating between the parameter on top and the parameter's Factory Setting on the bottom. In most cases, selections and values for the parameter will be listed on the right.

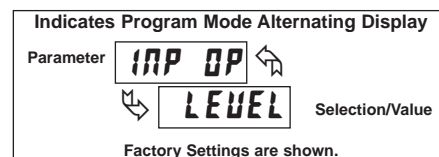

5.1 MODULE 1 - TIMER INPUT PARAMETERS (1-IMP)

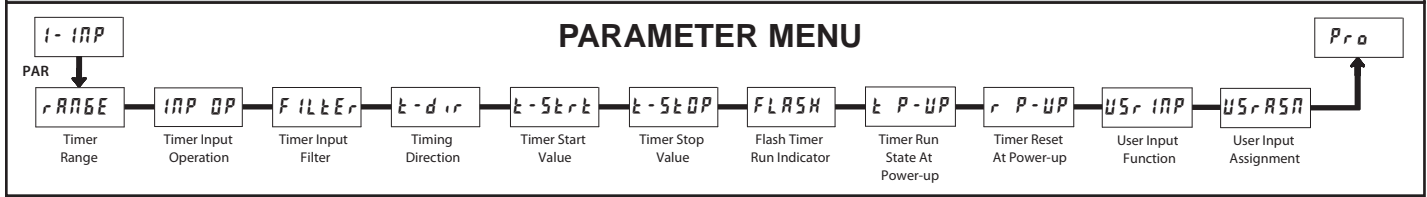

TIMER RANGE



18 TIMER RANGE SELECTIONS
(S = SEC; M = MIN; H = HR; d = DAY)

RANGE SELECTION	MAXIMUM DISPLAY	DISPLAY RESOLUTION	RANGE SELECTION	MAXIMUM DISPLAY	DISPLAY RESOLUTION
SECONDS			MINUTES/SECONDS		
555555	999999	1 SEC	MMSS	999959	1 SEC
555555	999999	0.1 SEC	MM555	999599	0.1 SEC
555555	999999	0.01 SEC	M5555	995999	0.01 SEC
555555	999999	0.001 SEC			
MINUTES			HOURS/MINUTES		
MM	999999	1 MIN	MMSS	999959	1 MIN
MM	999999	0.1 MIN	MM55	999599	0.1 MIN
MM	999999	0.01 MIN	M55	995999	0.01 MIN
			HOURS/MINUTES/SECONDS		
HOURS			MMSS	995959	1 SEC
HH	999999	1 HR	MMSS	995959	1 MIN
HH	999999	0.1 HR			
HH	999999	0.01 HR			

TIMER INPUT OPERATION

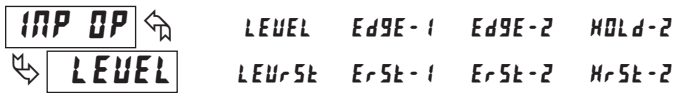

LEVEL EDGE-1 EDGE-2 HOLD-2
LEVEL LEU-5t Er-5t-1 Er-5t-2 Hr-5t-2

This parameter determines how the Timer Input Signals affect the Run/Stop status of the Timer. Timing diagrams are shown below for level active and edge triggered (1-input or 2-input) operation. For single input modes (Input A only), Input B provides a level active Timer Inhibit function. In the Display Hold mode, the timer display value remains held and only updates when a Timer Start (Input A) or Timer Stop (Input B) edge occurs.

The timer reset (r5t) operating modes are identical to the other modes in the diagrams, except the timer display value is reset at the Time Start edges.

The Timer can also be stopped at a Timer Stop Value or at Setpoint output activation or deactivation. This type of Stop condition is cleared when a Timer Reset occurs, or another start edge is applied on the timer input.

For Reset Modes (r5t), the timer is reset at Time Start edge.

LEVEL, LEU-5t

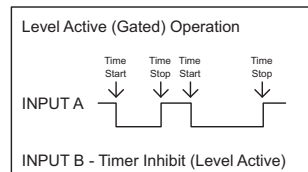

EDGE-1, Er-5t-1

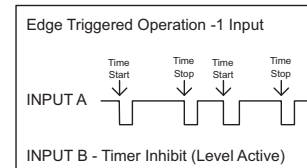

EDGE-2, Er-5t-2

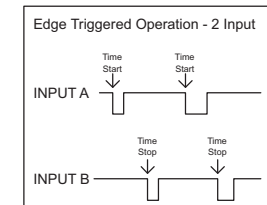

HOLD-2, Hr-5t-2

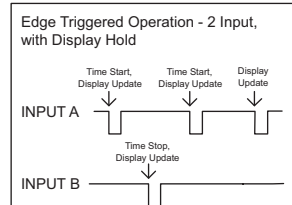

TIMER INPUT FILTER



ON OFF

Provides a 50 msec software debounce for the Timer Inputs (A and B). Select ON when using relays or switch contacts as a signal source.

TIMING DIRECTION

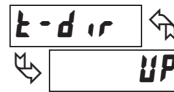

UP dn

Bi-directional timing capability. Select the timing direction desired for the application.

TIMER START VALUE



000000 to 999999

The Timer returns to this value whenever a Timer Reset occurs. The value is entered in the same display format as the Timer Range selected. Non-zero values are normally used for "timing down" applications, but they can also provide an offset value when timing up.

TIMER STOP VALUE



NO YES

The Timer stops when this value is reached regardless of the signal levels on the timer inputs. Selecting YES displays a sub-menu where the Stop Value is entered in the same display format as the Timer Range selected. This stop condition is cleared when a Timer Reset occurs or another start edge is applied on the timer input. Select NO if a Stop Value is not desired.



000000 to 999999

FLASH TIMER RUN INDICATOR

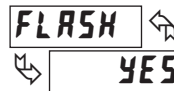

NO YES

Select YES to have the Timer Run indicator flash when the timer is running.

TIMER RUN STATE AT POWER-UP

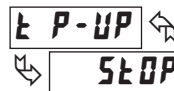

STOP SAUE

Determines the Run/Stop state of the Timer at Power-up. This parameter does not apply to LEVEL Input Operation.

STOP - Timer Stopped at power-up, regardless of prior Run/Stop state
SAUE - Timer assumes the Run/Stop state it was in prior to power-down

TIMER RESET AT POWER-UP



The Timer can be programmed to Reset at each meter power-up.

USER INPUT FUNCTION (Cont'd)

DISPLAY	MODE	DESCRIPTION
<i>inh ibt</i>	Inhibit	Inhibit timing or counting for the selected value(s).
<i>d-LEU</i>	Display Intensity Level (Edge Triggered)	Increase intensity one level for each activation.
<i>Pr int</i>	Print Request	Serial transmit of the active parameters selected in the Print Options menu (Module 5).
<i>Pr-rst</i>	Print and Reset	Same as Print Request followed by a momentary reset of the selected value(s).
<i>0-rst</i>	Reset Output	Edge triggered deactivation of the Setpoint Output.

USER INPUT FUNCTION



DISPLAY	MODE	DESCRIPTION
<i>NO</i>	No Function	User Input disabled.
<i>ProLoc</i>	Program Mode Lock-out	See Programming Mode Access chart (Module 3).
<i>d-SEL</i>	Display Select (Edge triggered)	Toggle display with each activation.
<i>rESEt</i>	Maintained Reset	Level active reset of the selected value(s).
<i>d-HOLD</i>	Display Hold	Freeze display for the selected value(s) while allowing time or counts to accumulate internally.
<i>Hd-rst</i>	Hold and Reset	Edge triggered reset of the selected value(s) after storing the time or count.

USER INPUT ASSIGNMENT



t-UAL
e-UAL
both

The User Input Assignment only applies if the cycle counter is enabled and a selection of reset, display hold, hold and reset, inhibit, or print and reset is selected in the User Input Function menu.

5.2 MODULE 2 - CYCLE COUNTER PARAMETERS (2-ENT)

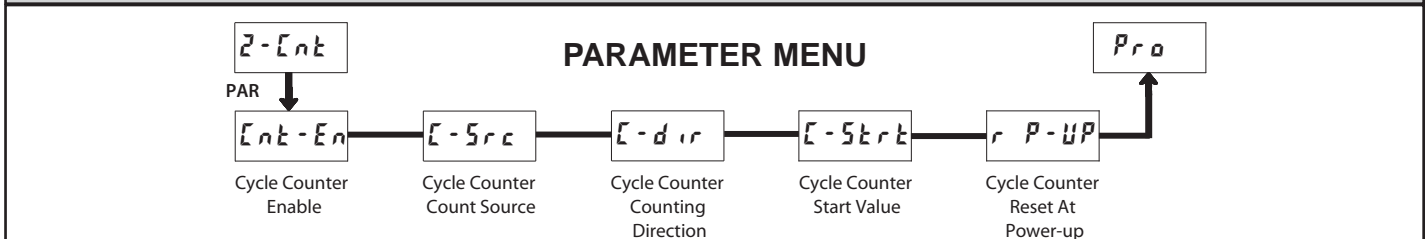

CYCLE COUNTER ENABLE



When set to *NO*, the remaining Cycle Counter parameters are not accessible.

CYCLE COUNTER COUNTING DIRECTION



Bi-directional counting capability. Select the counting direction desired for the application.

CYCLE COUNTER COUNT SOURCE



This parameter selects the source from which the Cycle Counter derives counts. The Timer Reset (*t-rst*) selection generates a count when either a manual or automatic timer reset occurs (See Module 4 for programming Automatic Reset). The Input B (*INP b*) selection generates a count each time Input B is activated. This selection overrides the timer inhibit function of Input B, when the timer is programmed for Level or Edge-1 operating mode (See Module 1 for Timer Input Operating Modes).

The User Input (*USR INP*) selection generates a count each time the User Input is activated. When selected as the count source, the User Input can still be set to perform a User Function described in Module 1. In this case, the Cycle Counter will count the number of times the selected User Function occurred.

The Output ON/OFF selections generate a count when the Setpoint output either activates or deactivates.

CYCLE COUNTER START VALUE



The Cycle Counter returns to this value whenever a Counter Reset occurs. Non-zero values are normally used for "down counting" applications, but can also provide an offset value when counting up.

CYCLE COUNTER RESET AT POWER-UP



The Cycle Counter can be programmed to Reset at each meter power-up.

5.3 MODULE 3 - DISPLAY AND FRONT PANEL KEY PARAMETERS (3-dSP)

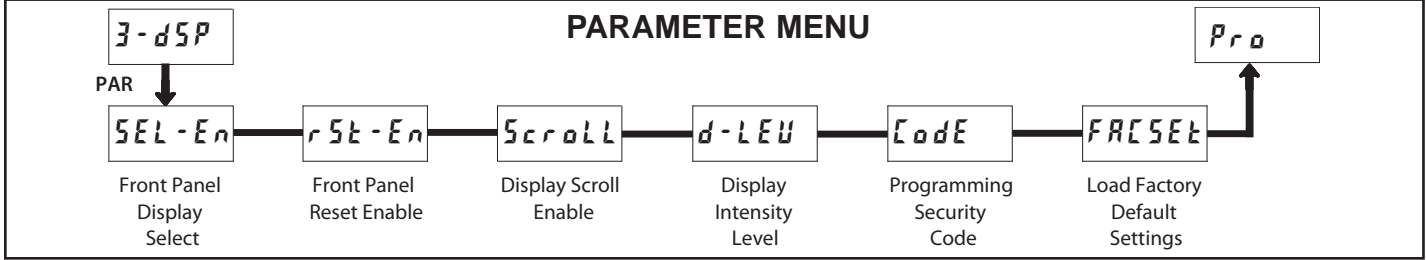

FRONT PANEL DISPLAY SELECT ENABLE (SEL▲)



The **YES** selection allows the **SEL▲** key to toggle between the timer and cycle counter displays.

FRONT PANEL RESET ENABLE (RST▼)



The **YES** selection allows the **RST▼** key to reset the selected value(s). The shaded selections only appear if the cycle counter is enabled.

DISPLAY SCROLL ENABLE



The **YES** selection allows the display to automatically scroll between the timer and cycle counter values. The scroll rate is about every 4 seconds.

DISPLAY INTENSITY LEVEL

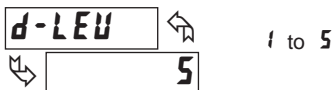

Enter the desired Display Intensity Level (1-5). The display will actively dim or brighten as levels are changed.

PROGRAMMING SECURITY CODE



The Security Code determines the programming mode and the accessibility of programming parameters. This code can be used along with the Program Mode Lock-out (**ProLoc**) in the User Input Function parameter (Module 1).

Two programming modes are available. Full Programming mode allows all parameters to be viewed and modified. Quick Programming mode permits only

the Setpoint values and Timer Stop value to be modified, but allows direct access to these values without having to enter Full Programming mode.

Programming a Security Code other than 0, requires this code to be entered at the **Code** prompt in order to access Full Programming mode. Depending on the code value, Quick Programming may be accessible before the **Code** prompt appears (see chart).

USER INPUT FUNCTION	USER INPUT STATE	SECURITY CODE	MODE WHEN "PAR" KEY IS PRESSED	FULL PROGRAMMING MODE ACCESS
not ProLoc	---	0	Full Programming	Immediate Access
		1-99	Quick Programming	After Quick Programming with correct code entry at Code prompt *
		100-999	Code prompt	With correct code entry at Code prompt *
ProLoc	Active	0	Programming Lock	No Access
		1-99	Quick Programming	No Access
		100-999	Code prompt	With correct code entry at Code prompt *
	Not Active	0-999	Full Programming	Immediate Access

* Entering Code 222 allows access regardless of security code.

LOAD FACTORY DEFAULT SETTINGS



The **YES** selection will return the meter to the factory default settings. The meter will display **rESEt** and then return to **Pra**, at which time all settings have been changed.

5.4 MODULE 4 - SETPOINT OUTPUT PARAMETERS (4-SPt)

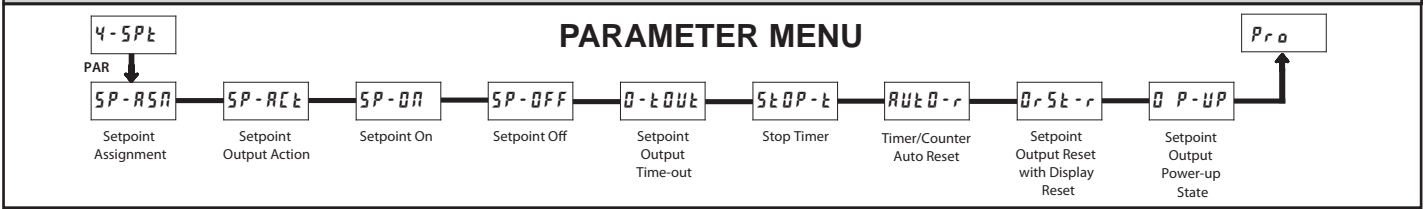

Module 4 is the programming module for the Setpoint Output parameters. Some parameters will not appear depending on the Setpoint Assignment and Setpoint Output Action selected.

SETPOINT ASSIGNMENT

SP-RSA t-UAL C-UAL

Select the display for Setpoint assignment.

SETPOINT OUTPUT ACTION

SP-Act LActH t-OUT ON-OFF

This parameter selects the action of the Setpoint output as shown below.

SPT ACTION	DESCRIPTION	OUTPUT ACTIVATES	OUTPUT DEACTIVATES
LActH	Latched Output Mode	When Time or Count = Setpoint On value	At Manual Reset (if OrSt-r = YES)
t-OUT	Timed Output Mode	When Time or Count = Setpoint On value	After Setpoint Output Time-Out
ON-OFF	On-Off Output Mode	When Time or Count = Setpoint On value	When Time or Count = Setpoint Off value

SETPOINT ON

SP-ON UALUE t-Start t-Stop

This parameter determines when the Setpoint output will activate. The output can activate at a programmed Setpoint Value or can be set to activate when the Timer starts (t-Start) or stops (t-Stop).

Selecting UALUE displays a sub-menu where the Setpoint Value is entered. If the Setpoint is assigned to the Timer, the value is entered in the same display format as the selected Timer Range.

ON-UAL 000000 to 999999 000 100

SETPOINT OFF

SP-OFF UALUE t-Start t-Stop

The Setpoint Off parameter only appears if the Setpoint Action is set to On-Off Output mode (ON-OFF). In this mode, the Setpoint OFF parameter determines when the Setpoint Output will deactivate. The output can be programmed to deactivate at a Setpoint Off Value or can be set to deactivate when the Timer starts (t-Start) or stops (t-Stop).

Selecting UALUE displays a sub-menu where the Setpoint Off Value is entered. If the Setpoint is assigned to the Timer, the value is entered in the same display format as the selected Timer Range.

OF-UAL 000000 to 999999 000200

SETPOINT OUTPUT TIME-OUT

t-OUT 000001 to 995999 000 100

This parameter is only active if the Setpoint Action is set to Timed Output mode (t-OUT). Enter the time duration the Setpoint Output will remain ON once it is activated. This value is always entered in minutes, seconds, and hundredths of seconds format. The maximum value is 99 minutes 59.99 seconds.

STOP TIMER

StOP-t NO t-ON t-OFF

Stops the Timer when the Setpoint output activates (t-ON) or deactivates (t-OFF). Select NO if the output should not affect the Timer Run/Stop status.

The Timer Stop condition is cleared when a Timer Reset occurs, or a Time Start edge is applied on the Timer input.

TIMER/COUNTER AUTO RESET

AUtO-r NO t-ON t-OFF

Automatically resets the Setpoint Assigned display value when the Setpoint Output activates (t-ON) or deactivates (t-OFF). Select NO if the output should not cause a display reset.

SETPOINT OUTPUT RESET WITH DISPLAY RESET

OrSt-r YES NO YES

Select YES to have the Setpoint Output deactivate (reset) when the Setpoint Assigned display resets. Reset can occur by the RST key or the User Input, if programmed for that function. Select NO if the Setpoint output should not reset when the display resets.

SETPOINT OUTPUT POWER-UP STATE

OP-UP OFF ON SAVE

SAVE will restore the output to the same state it was at before the meter was powered down. ON will activate the output at power up. OFF will deactivate the output at power up. This parameter is not active when the Setpoint Action is selected for timed output mode.

5.5 MODULE 5 - SERIAL COMMUNICATIONS PARAMETERS (5-5Er)

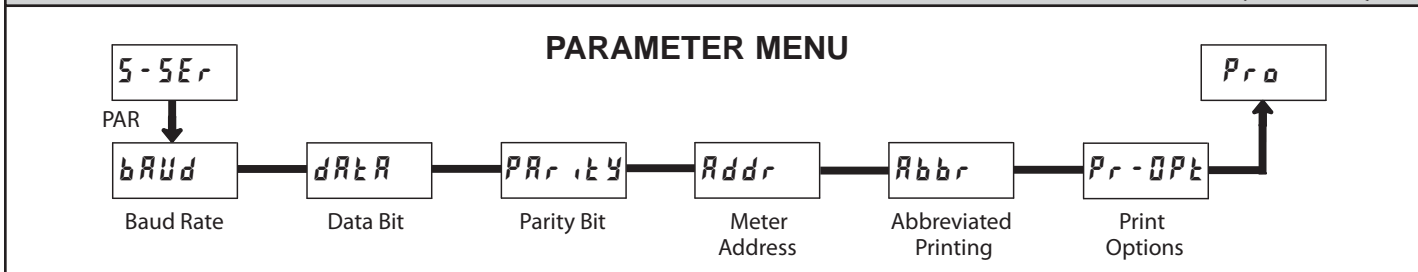

Module 5 is the programming module for the Serial Communications Parameters. These parameters are used to match the serial settings of the meter with those of the host computer or other serial device.

BAUD RATE

bAUD 9600

300	1200	4800	19200
600	2400	9600	38400

Set the baud rate to match that of other serial communications equipment. Normally, the baud rate is set to the highest value that all of the serial communications equipment is capable of transmitting and receiving.

DATA BIT

dAtA 8-bit

7-bit 8-bit

Select either 7- or 8-bit data word length. Set the word length to match the other serial communications equipment on the serial link.

PARITY BIT

PARity NO

NO Odd Even

This parameter only appears when the Data Bit parameter is set to a 7-bit data word length. Set the parity bit to match that of the other serial equipment on the serial link. The meter ignores parity when receiving data and sets the parity bit for outgoing data. If parity is set to **NO**, an additional stop bit is used to force the frame size to 10 bits.

METER ADDRESS

Addr 00

0 to 99

Enter the serial node address. With a single unit, an address is not needed and a value of zero can be used (RS232 applications). Otherwise, with multiple bussed units, a unique address number must be assigned to each meter. The node address applies specifically to RS485 applications.

ABBREVIATED PRINTING

Abbr NO YES

NO

This parameter determines the formatting of data transmitted from the meter in response to a Transmit Value command or a Block Print Request. Select **NO** for a full print transmission, consisting of the meter address, mnemonics, and parameter data. Select **YES** for abbreviated print transmissions, consisting of the parameter data only. This setting is applied to all the parameters selected in the PRINT OPTIONS. (Note: If the meter address is 0, the address will not be sent during a full transmission.)

PRINT OPTIONS

Pr-OPt NO YES

NO

This parameter selects the meter values transmitted in response to a Print Request. A print request is also referred to as a block print because more than one parameter can be sent to a printer or computer as a block.

Selecting **YES** displays a sublist for choosing the meter parameters to appear in the print block. All active parameters entered as **YES** in the sublist will be transmitted during a block print. Parameters entered as **NO** will not be sent.

The "Print All" (**Pr-ALL**) option selects all meter values for transmitting (**YES**), without having to individually select each parameter in the sublist.

Note: Inactive parameters will not be sent regardless of the print option setting. For example, the Cycle Counter and Cycle Counter Start values will only be sent when the Cycle Counter is enabled. If disabled, these parameters are inactive and will not be transmitted. Likewise, only the Setpoint parameters that apply to the programmed Setpoint Output Action will be transmitted.

DISPLAY	DESCRIPTION	FACTORY SETTING	MNEMONIC
t-URL	Timer	YES	TMR
C-URL	Cycle Counter	NO	CNT
t-Start	Timer Start	NO	TST
t-Stop	Timer Stop	NO	TSP
C-Start	Counter Start	NO	CST
SP-ON	Setpoint ON	NO	SPT
SP-OFF	Setpoint OFF	NO	SOF
t-TOU	Setpoint Time-out	NO	STO

Sending Serial Commands and Data

When sending commands to the meter, a string containing at least one command character must be constructed. A command string consists of a command character, a value identifier, numerical data (if writing data to the meter) followed by a command terminator character, * or \$.

Command Chart

Command	Description	Notes
N	Node (meter) Address Specifier	Address a specific meter. Must be followed by one or two digit node address. Not required when node address = 0.
T	Transmit Value (read)	Read a register from the meter. Must be followed by a register ID character.
V	Value Change (write)	Write to register of the meter. Must be followed by a register ID character and numeric data.
R	Reset	Reset a value or the output. Must be followed by a register ID character
P	Block Print Request (read)	Initiates a block print output. Registers in the print block are selected in Print Options.

Command String Construction

The command string must be constructed in a specific sequence. The meter does not respond with an error message to illegal commands. The following procedure details construction of a command string:

1. The first 2 or 3 characters consist of the Node Address Specifier (N) followed by a 1 or 2 character node address number. The node address number of the meter is programmable. If the node address is 0, this command and the node address itself may be omitted. This is the only command that may be used in conjunction with other commands.
2. After the optional address specifier, the next character is the command character.
3. The next character is the register ID. This identifies the register that the command affects. The P command does not require a register ID character. It prints all the active selections chosen in the Print Options menu parameter.
4. If constructing a value change command (writing data), the numeric data is sent next.
5. All command strings must be terminated with the string termination characters * or \$. The meter does not begin processing the command string until this character is received. See timing diagram figure for differences in meter response time when using the * and \$ terminating characters.

Receiving Data From The Meter

Data is transmitted from the meter in response to either a transmit command (T), a block print request command (P) or a User Input print request. The response from the meter is either a full field transmission or an abbreviated transmission, depending on the selection chosen in Module 5.

Full Field Transmission

Byte	Description
1, 2	2 byte Node Address field [00-99]
3	<SP> (Space)
4-6	3 byte Register Mnemonic field
7-18	12 byte data field; 9 bytes for number and three bytes for decimal points
19	<CR> (carriage return)
20	<LF> (line feed)
21	<SP>* (Space)
22	<CR>* (carriage return)
23	<LF>* (line feed)

* These characters only appear in the last line of a block print.

The first two characters transmitted are the meter address. If the address assigned is 0, two spaces are substituted. A space follows the meter address field. The next three characters are the register mnemonic, as shown in the Register Identification Chart.

The numeric data is transmitted next. The numeric field (bytes 7 to 18) is 12 characters long. When a display overflow exists for a requested timer or cycle counter value, an * (used as an overflow character) replaces a space in byte 7. Byte 8 is always a space.

The remaining ten positions of this field consist of seven positions for the

Register Identification Chart

ID	Value Description	MNEMONIC	Applicable Commands	Transmit Details (T and V)
A	Timer	TMR	T, V, R	6 digit, per Timer Range
B	Cycle Counter	CNT	T, V, R	5 digit
C	Timer Start	TST	T, V	6 digit, per Timer Range
D	Timer Stop	TSP	T, V	6 digit, per Timer Range
E	Counter Start	CST	T, V	5 digit
F	Setpoint ON (Reset Output)	SPT	T, V, R	per Setpoint Assignment, same as Timer or Counter
G	Setpoint OFF	SOF	T, V	per Setpoint Assignment, same as Timer or Counter
H	Setpoint Time-out	STO	T, V	6 digit, mm.ss.ss format

Command String Examples:

1. Node address = 17, Write 350 to the Setpoint On value
String: N17VF350\$
2. Node address = 5, Read Timer value, response time of 50 msec min
String: N5TA*
3. Node address = 0, Reset Setpoint output
String: RF*
4. Node address = 31, Request a Block Print Output, response time of 2 msec min
String: N31P\$

Transmitting Data to the Meter

Numeric data sent to the meter must be limited to Transmit Details listed in the Register Identification Chart. Leading zeros are ignored. The meter ignores any decimal point and conforms the number to the appropriate display format. (For example: The Timer range is set for tenths of a second and 25 is written to the Timer Start register. The value of the register is now 2.5 seconds. In this case, write a value of 250 to equal 25.0 seconds).

Note: Since the meter does not issue a reply to value change commands, follow with a transmit value command for readback verification.

requested value with decimal points positioned for the selected timer range. The data within bytes 9 to 18 is right-aligned with leading spaces for any unfilled positions.

The end of the response string is terminated with a <CR> and <LF>. After the last line of a block print, an extra <SP>, <CR> and <LF> are added to provide separation between the print blocks.

Abbreviated Transmission

Byte	Description
1-12	12 byte data field, 9 bytes for number and three bytes for decimal points
13	<CR> (carriage return)
14	<LF> (line feed)
15	<SP>* (Space)
16	<CR>* (carriage return)
17	<LF>* (line feed)

* These characters only appear in the last line of a block print.

The abbreviated response suppresses the node address and register mnemonic, leaving only the numeric part of the response.

Meter Response Examples:

1. Node address = 17, full field response, Cycle Counter = 875
17 CNT 875 <CR><LF>
2. Node address = 0, full field response, Setpoint On value = 250.5
SPT 250.5<CR><LF>
3. Node address = 0, abbreviated response, Setpoint On value= 250, last line of block print
250<CR><LF><SP><CR><LF>

Command Response Time

The meter can only receive data or transmit data at any one time (half-duplex operation). During RS232 transmissions, the meter ignores commands while transmitting data, but instead uses RXD as a busy signal. When sending commands and data to the meter, a delay must be imposed before sending another command. This allows enough time for the meter to process the command and prepare for the next command.

At the start of the time interval t_1 , the computer program prints or writes the string to the com port, thus initiating a transmission. During t_1 , the command characters are under transmission and at the end of this period, the command terminating character (* or \$) is received by the meter. The time duration of t_1 is dependent on the number of characters and baud rate of the channel.

$$t_1 = (10 \text{ times the \# of characters}) / \text{baud rate}$$

At the start of time interval t_2 , the meter starts the interpretation of the command and when complete, performs the command function. This time interval t_2 varies. If no response from the meter is expected, the meter is ready to accept another command.

If the meter is to reply with data, the time interval t_2 is controlled by the use of the command terminating character. The '*' terminating character results in a response time of 50 msec. minimum. This allows sufficient time for the release of the sending driver on the RS485 bus. Terminating the command line with '\$' results in a response time (t_2) of 2 msec. minimum. The faster response time of this terminating character requires that sending drivers release within 2 msec. after the terminating character is received.

At the beginning of time interval t_3 , the meter responds with the first character of the reply. As with t_1 , the time duration of t_3 is dependent on the number of characters and baud rate of the channel. At the end of t_3 , the meter is ready to receive the next command.

$$t_3 = (10 \text{ times the \# of characters}) / \text{baud rate}$$

The maximum serial throughput of the meter is limited to the sum of the times t_1 , t_2 and t_3 .

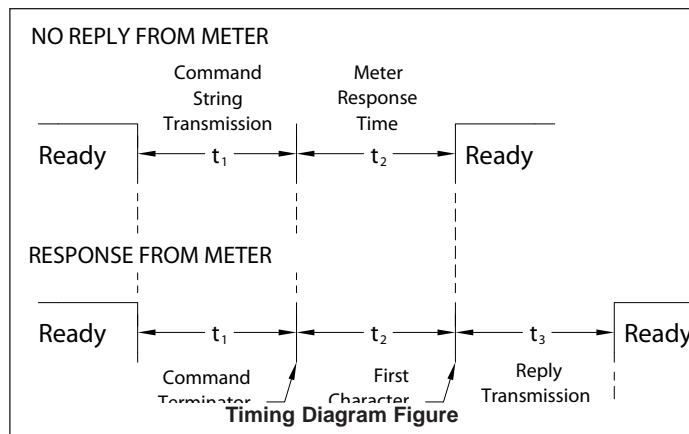

Communication Format

Data is transferred from the meter through a serial communication channel. In serial communications, the voltage is switched between a high and low level at a predetermined rate (baud rate) using ASCII encoding. The receiving device reads the voltage levels at the same intervals and then translates the switched levels back to a character. The voltage level conventions depend on the interface standard. The table lists the voltage levels for each standard.

LOGIC	INTERFACE STATE	RS232*	RS485*
1	mark (idle)	TXD,RXD; -3 to -15 V	a-b < -200 mV
0	space (active)	TXD,RXD; +3 to +15 V	a-b > +200 mV

* Voltage levels at the Receiver

Data is transmitted one byte at a time with a variable idle period between characters (0 to ∞). Each ASCII character is "framed" with a beginning start bit, an optional parity bit and one or more ending stop bits. The data format and baud rate must match that of other equipment in order for communication to take place. The figures list the data formats employed by the meter.

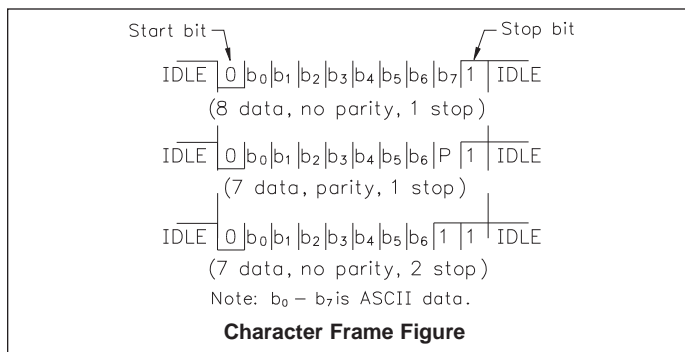

Start Bit and Data Bits

Data transmission always begins with the start bit. The start bit signals the receiving device to prepare for reception of data. One bit period later, the least significant bit of the ASCII encoded character is transmitted, followed by the remaining data bits. The receiving device then reads each bit position as they are transmitted.

Parity Bit

After the data bits, the parity bit is sent. The transmitter sets the parity bit to a zero or a one, so that the total number of ones contained in the transmission (including the parity bit) is either even or odd. This bit is used by the receiver to detect errors that may occur to an odd number of bits in the transmission. However, a single parity bit cannot detect errors that may occur to an even number of bits. Given this limitation, the parity bit is often ignored by the receiving device. The LD Timer ignores the parity bit of incoming data and sets the parity bit to odd, even or none (mark parity) for outgoing data.

Stop Bit

The last character transmitted is the stop bit. The stop bit provides a single bit period pause to allow the receiver to prepare to re-synchronize to the start of a new transmission (start bit of next byte). The receiver then continuously looks for the occurrence of the start bit. If 7 data bits and no parity is selected, then 2 stop bits are sent from the meter.

This page intentionally left blank.

LIMITED WARRANTY

The Company warrants the products it manufactures against defects in materials and workmanship for a period limited to two years from the date of shipment, provided the products have been stored, handled, installed, and used under proper conditions. The Company's liability under this limited warranty shall extend only to the repair or replacement of a defective product, at The Company's option. The Company disclaims all liability for any affirmation, promise or representation with respect to the products.

The customer agrees to hold Red Lion Controls harmless from, defend, and indemnify RLC against damages, claims, and expenses arising out of subsequent sales of RLC products or products containing components manufactured by RLC and based upon personal injuries, deaths, property damage, lost profits, and other matters which Buyer, its employees, or sub-contractors are or may be to any extent liable, including without limitation penalties imposed by the Consumer Product Safety Act (P.L. 92-573) and liability imposed upon any person pursuant to the Magnuson-Moss Warranty Act (P.L. 93-637), as now in effect or as amended hereafter.

No warranties expressed or implied are created with respect to The Company's products except those expressly contained herein. The Customer acknowledges the disclaimers and limitations contained herein and relies on no other warranties or affirmations.

Red Lion Controls
Headquarters
20 Willow Springs Circle
York PA 17406
Tel +1 (717) 767-6511
Fax +1 (717) 764-0839

Red Lion Controls
Europe
Printerweg 10
NL - 3821 AD Amersfoort
Tel +31 (0) 334 723 225
Fax +31 (0) 334 893 793

Red Lion Controls
India
54, Vishvas Tenement
GST Road, New Ranip,
Ahmedabad-382480 Gujarat, India
Tel +91 987 954 0503
Fax +91 79 275 31 350

Red Lion Controls
China
Unit 101, XinAn Plaza
Building 13, No.99 Tianzhou Road
ShangHai, P.R. China 200223
Tel +86 21 6113-3688
Fax +86 21 6113-3683