

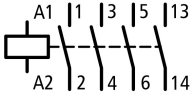

Contactor, 24 V 50 Hz, 3 pole, 380 V 400 V, 4 kW, Contacts N/O = Normally open= 1 N/O, Screw terminals, AC operation

Part no. DILEM-10(24V50HZ)
Catalog No. 010005
Alternate Catalog XTMC9A10U
No.
EL-Nummer 4130377
(Norway)

Delivery program

Product range				Contactors
Application				Mini Contactors for Motors and Resistive Loads
Subrange				DILEM contactors
Utilization category				AC-1: Non-inductive or slightly inductive loads, resistance furnaces NAC-3: Normal AC induction motors: starting, switch off during running AC-4: Normal AC induction motors: starting, plugging, reversing, inching
Notes				 Also suitable for motors with efficiency class IE3. IE3-ready devices are identified by the logo on their packaging.
Connection technique				Screw terminals
Description				With auxiliary contact
Number of poles				3 pole
Rated operational current				
AC-3				
380 V 400 V	I_e	A	9	
AC-1				
Conventional free air thermal current, 3 pole, 50 - 60 Hz				
Open				
at 40 °C	$I_{th} = I_e$	A	22	
Max. rating for three-phase motors, 50 - 60 Hz				
AC-3				
220 V 230 V	P	kW	2.2	
380 V 400 V	P	kW	4	
660 V 690 V	P	kW	4	
AC-4				
220 V 230 V	P	kW	1.5	
380 V 400 V	P	kW	3	
660 V 690 V	P	kW	3	
Contacts				
N/O = Normally open				1 N/O
Contact sequence				
For use with				...DILEM ...DILE
Actuating voltage				24 V 50 Hz
Voltage AC/DC				AC operation

Technical data

General				
Standards				IEC/EN 60947, VDE 0660, CSA, UL
Lifespan, mechanical; Coil 50/60 Hz	Operations	$\times 10^6$	7	
Lifespan, mechanical	Operations	$\times 10^6$	10	

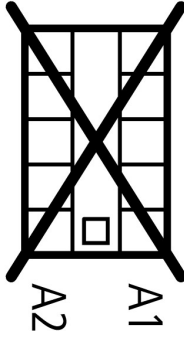
Maximum operating frequency			
Mechanical	Ops./h		9000
electrical (Contactors without overload relay)	Operations/h		Page 05/070
Climatic proofing			Damp heat, constant, to IEC 60068-2-78 Damp heat, cyclic, to IEC 60068-2-30
Ambient temperature			
Open	°C		-25 - +50
Enclosed	°C		- 25 - 40
Storage	°C		
Min. ambient temperature, storage	°C		- 40
Ambient temperature, storage max.	°C		+ 80
Mounting position			As required, except vertical with terminals A1/A2 at the bottom
Mounting position			
Mechanical shock resistance (IEC/EN 60068-2-27)			
Half-sinusoidal shock, 10 ms			
Basic unit without auxiliary contact module			
Main contacts, make contacts	g		10
Main contacts Make/break contacts	g		
Make	g		8
Basic unit with auxiliary contact module			
Main contacts make contact	g		
Make	g		10
Auxiliary contacts Make/break contacts	g		20 / 20
Degree of Protection			IP20
Protection against direct contact when actuated from front (EN 50274)			Finger and back-of-hand proof
Weight	kg		0.17
Terminal capacity of auxiliary and main contacts			
Screw terminals			
Solid	mm ²		1 x (0.75 - 2.5) 2 x (0.75 - 2.5)
Flexible with ferrule	mm ²		1 x (0.75 - 1.5) 2 x (0.75 - 1.5)
Solid or stranded	AWG		18 - 14
Stripping length	mm		8
Terminal screw			M3.5
Pozidriv screwdriver	Size		2
Standard screwdriver	mm		0.8 x 5.5 1 x 6
Max. tightening torque	Nm		1.2
Main conducting paths			
Rated impulse withstand voltage	U _{imp}	V AC	6000
Overvoltage category/pollution degree			III/3
Rated insulation voltage	U _i	V AC	690
Rated operational voltage	U _e	V AC	690
Safe isolation to EN 61140			
between coil and contacts		V AC	300
between the contacts		V AC	300
Making capacity (cos φ to IEC/EN 60947)		A	110

Breaking capacity			
220 V 230 V		A	90
380 V 400 V		A	90
500 V		A	64
660 V 690 V		A	42
Short-circuit protection maximum fuse			
Type "2", 500 V	gL/gG	A	10
Type "1", 500 V	gL/gG	A	20

AC

AC-1			
Rated operational current			
Conventional free air thermal current, 3 pole, 50 - 60 Hz			
Open			
at 40 °C	$I_{th} = I_e$	A	22
at 50 °C	$I_{th} = I_e$	A	20
at 55 °C	$I_{th} = I_e$	A	19
enclosed	I_{th}	A	16
Notes			At maximum permissible ambient air temperature.
Conventional free air thermal current, 1 pole			
Notes			At maximum permissible ambient air temperature.
open	I_{th}	A	50
enclosed	I_{th}	A	40
AC-3			
Rated operational current			
Open, 3-pole: 50 – 60 Hz			
Notes			At maximum permissible ambient air temperature.
220 V 230 V	I_e	A	9
240 V	I_e	A	9
380 V 400 V	I_e	A	9
415 V	I_e	A	9
440V	I_e	A	9
500 V	I_e	A	6.4
660 V 690 V	I_e	A	4.8
Motor rating		P	kWh
220 V 230 V	P	kW	2.2
240V	P	kW	2.5
380 V 400 V	P	kW	4
415 V	P	kW	4.3
440 V	P	kW	4.6
500 V	P	kW	4
660 V 690 V	P	kW	4
AC-4			
Rated operational current			
Open, 3-pole: 50 – 60 Hz			
Notes			At maximum permissible ambient air temperature.
220 V 230 V	I_e	A	6.6
240 V	I_e	A	6.6
380 V 400 V	I_e	A	6.6
415 V	I_e	A	6.6
440 V	I_e	A	6.6
500 V	I_e	A	5
660 V 690 V	I_e	A	3.4
Motor rating		P	kWh
220 V 230 V	P	kW	1.5

240 V	P	kW	1.8
380 V 400 V	P	kW	3
415 V	P	kW	3.1
440 V	P	kW	3.3
500 V	P	kW	3
660 V 690 V	P	kW	3

DC

Rated operational current open			
DC-1			
12 V	I_e	A	20
24 V	I_e	A	20
60 V	I_e	A	20
110 V	I_e	A	20
220 V	I_e	A	20
Current heat losses (3- or 4-pole)			
at I_{th} , 50 °C		W	5.9
at I_e to AC-3/400 V		W	1.2

Magnet systems

Voltage tolerance			
AC operated			
Single-voltage coil 50 Hz and dual-voltage coil 50 Hz, 60 Hz	Pick-up	$x U_c$	0.8 - 1.1
Dual-frequency coil 50/60 Hz	Pick-up	$x U_c$	
Voltage tolerance Dual-frequency coil 50/60 Hz, max. pick-up voltage		$x U_c$	1.1
Power consumption			
AC operation			
Single-voltage coil 50 Hz and dual-voltage coil 50 Hz, 60 Hz	Pick-up	VA	25
Single-voltage coil 50 Hz and dual-voltage coil 50 Hz, 60 Hz	Pick-up	W	22
Single-voltage coil 50 Hz and dual-voltage coil 50 Hz, 60 Hz	Sealing	VA	4.6
Single-voltage coil 50 Hz and dual-voltage coil 50 Hz, 60 Hz	Sealing	W	1.8
Duty factor		% DF	100
Switching times at 100 % U_c			
Make contact		ms	
Closing delay		ms	
Closing delay min.		ms	14
Closing delay max.		ms	21
Opening delay		ms	
Opening delay min.		ms	8
Opening delay max.		ms	18
Closing delay with top mounting auxiliary contact		ms	45
Reversing contactors			
Changeover time at 110 % U_c			
Changeover time min.		ms	16
Changeover time max.		ms	21
Arcing time at 690 V AC		ms	12

Auxiliary contacts

Positive operating contacts to EN 60947-5-1 appendix L, including auxiliary contact module			Yes
Rated impulse withstand voltage	U_{imp}	V AC	6000
Overvoltage category/pollution degree			III/3
Rated insulation voltage	U_i	V AC	690
Rated operational voltage	U_e	V AC	600
Safe isolation to EN 61140			
between coil and auxiliary contacts		V AC	300
between the auxiliary contacts		V AC	300
Rated operational current			

AC-15				
220 V 240 V	I_e	A		6
380 V 415 V	I_e	A		3
500 V	I_e	A		1.5
DC L/R \leq 15 ms				
Contacts in series:		A		
1	24 V	A		2.5
2	60 V	A		2.5
3	100 V	A		1.5
3	220 V	A		0.5
Conv. thermal current	I_{th}	A		10
Control circuit reliability	Failure rate	λ		$<10^{-8}$, < one failure at 100 million operations (at $U_e = 24$ V DC, $U_{min} = 17$ V, $I_{min} = 5.4$ mA)
Component lifespan at $U_e = 240$ V				
AC-15	Operations	$\times 10^6$		0.2
DC current				
L/R = 50 ms: 2 contacts in series at $I_e = 0.5$ A	Operations	$\times 10^6$		0.15
Notes				Switch-on and switch-off conditions based on DC-13, time constant as specified
Short-circuit rating without welding				
Maximum overcurrent protective device				
Short-circuit protection only				PKZM0-4
Short-circuit protection maximum fuse				
500 V		A gG/gL		6
500 V		A fast		10
Current heat loss at a load of I_{th} per contact		W		1.1

Rating data for approved types

Switching capacity				
Maximum motor rating				
Three-phase				
200 V 208 V		HP		2
230 V 240 V		HP		3
460 V 480 V		HP		5
575 V 600 V		HP		5
Single-phase				
115 V 120 V		HP		0.5
230 V 240 V		HP		1.5
General use		A		15
Auxiliary contacts				
Pilot Duty				
AC operated				A600
DC operated				P300
General Use				
AC		V		600
AC		A		10
DC		V		250
DC		A		0.5
Short Circuit Current Rating		SCCR		
Basic Rating				
SCCR		kA		5
max. Fuse		A		45

Design verification as per IEC/EN 61439

Technical data for design verification			
Rated operational current for specified heat dissipation	I_n	A	9
Heat dissipation per pole, current-dependent	P_{vid}	W	0.4
Equipment heat dissipation, current-dependent	P_{vid}	W	1.2
Static heat dissipation, non-current-dependent	P_{vs}	W	1.8
Heat dissipation capacity	P_{diss}	W	0
Operating ambient temperature min.		°C	-25
Operating ambient temperature max.		°C	50
IEC/EN 61439 design verification			
10.2 Strength of materials and parts			
10.2.2 Corrosion resistance			
			Meets the product standard's requirements.
10.2.3.1 Verification of thermal stability of enclosures			
			Meets the product standard's requirements.
10.2.3.2 Verification of resistance of insulating materials to normal heat			
			Meets the product standard's requirements.
10.2.3.3 Verification of resistance of insulating materials to abnormal heat and fire due to internal electric effects			
			Meets the product standard's requirements.
10.2.4 Resistance to ultra-violet (UV) radiation			
			Meets the product standard's requirements.
10.2.5 Lifting			
			Does not apply, since the entire switchgear needs to be evaluated.
10.2.6 Mechanical impact			
			Does not apply, since the entire switchgear needs to be evaluated.
10.2.7 Inscriptions			
			Meets the product standard's requirements.
10.3 Degree of protection of ASSEMBLIES			
			Does not apply, since the entire switchgear needs to be evaluated.
10.4 Clearances and creepage distances			
			Meets the product standard's requirements.
10.5 Protection against electric shock			
			Does not apply, since the entire switchgear needs to be evaluated.
10.6 Incorporation of switching devices and components			
			Does not apply, since the entire switchgear needs to be evaluated.
10.7 Internal electrical circuits and connections			
			Is the panel builder's responsibility.
10.8 Connections for external conductors			
			Is the panel builder's responsibility.
10.9 Insulation properties			
10.9.2 Power-frequency electric strength			
			Is the panel builder's responsibility.
10.9.3 Impulse withstand voltage			
			Is the panel builder's responsibility.
10.9.4 Testing of enclosures made of insulating material			
			Is the panel builder's responsibility.
10.10 Temperature rise			
			The panel builder is responsible for the temperature rise calculation. Eaton will provide heat dissipation data for the devices.
10.11 Short-circuit rating			
			Is the panel builder's responsibility. The specifications for the switchgear must be observed.
10.12 Electromagnetic compatibility			
			Is the panel builder's responsibility. The specifications for the switchgear must be observed.
10.13 Mechanical function			
			The device meets the requirements, provided the information in the instruction leaflet (IL) is observed.

Technical data ETIM 7.0

Low-voltage industrial components (EG000017) / Power contactor, AC switching (EC000066)			
Electric engineering, automation, process control engineering / Low-voltage switch technology / Contactor (LV) / Power contactor, AC switching (ecl@ss10.0.1-27-37-10-03 [AAB718015])			
Rated control supply voltage U_s at AC 50HZ		V	24 - 24
Rated control supply voltage U_s at AC 60HZ		V	0 - 0
Rated control supply voltage U_s at DC		V	0 - 0
Voltage type for actuating			AC
Rated operation current I_e at AC-1, 400 V		A	22
Rated operation current I_e at AC-3, 400 V		A	9
Rated operation power at AC-3, 400 V		kW	4
Rated operation current I_e at AC-4, 400 V		A	6.6
Rated operation power at AC-4, 400 V		kW	3
Rated operation power NEMA		kW	3.7
Modular version			No
Number of auxiliary contacts as normally open contact			1
Number of auxiliary contacts as normally closed contact			0
Type of electrical connection of main circuit			Screw connection
Number of normally closed contacts as main contact			0

Approvals

Product Standards	IEC/EN 60947-4-1; UL 508; CSA-C22.2 No. 14-05; CE marking
UL File No.	E29096
UL Category Control No.	NLDX
CSA File No.	012528
CSA Class No.	3211-04
North America Certification	UL listed, CSA certified
Specially designed for North America	No

Characteristics

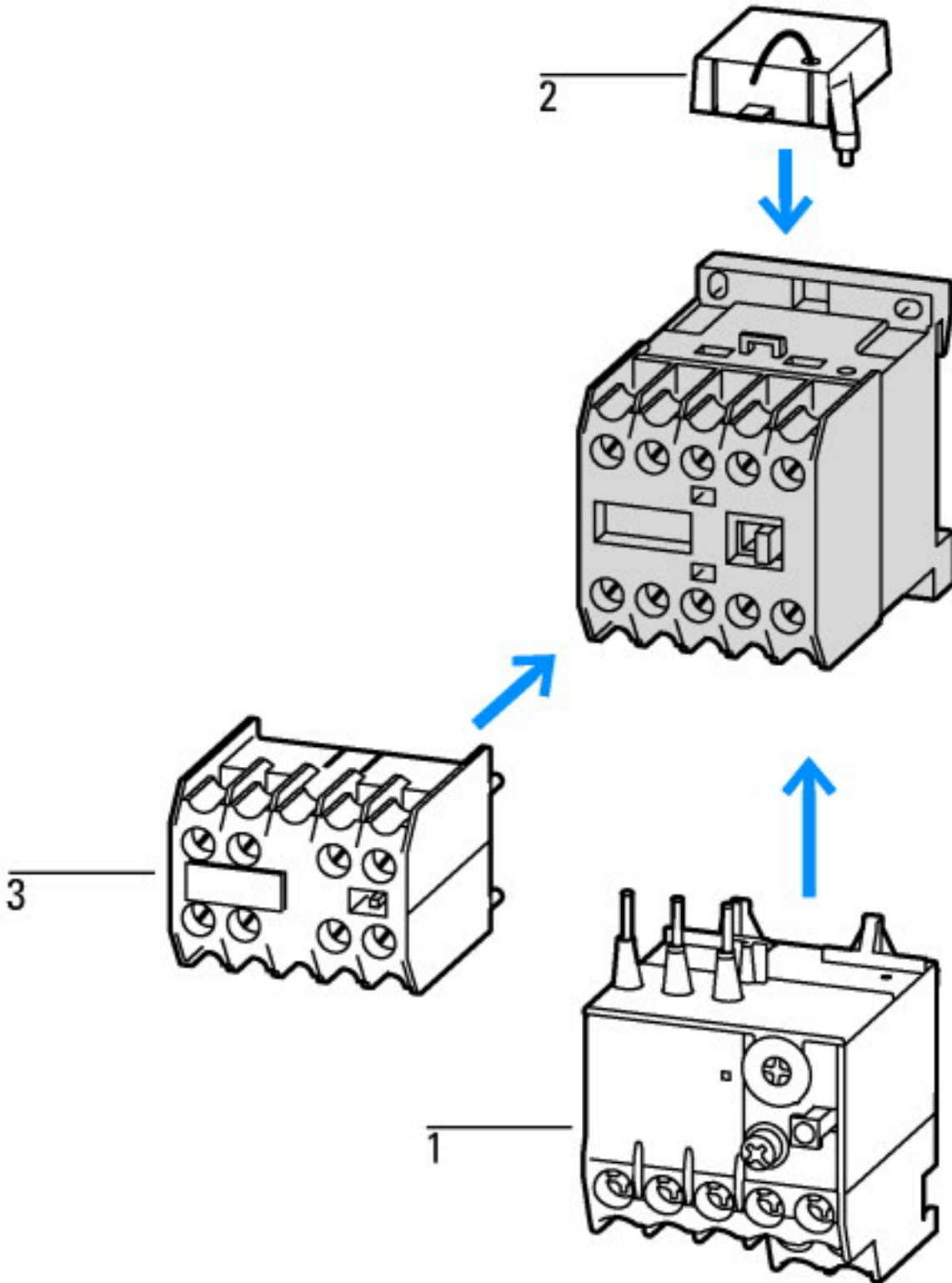

- 1: Overload relay
- 2: Suppressor
- 3: Auxiliary contact modules

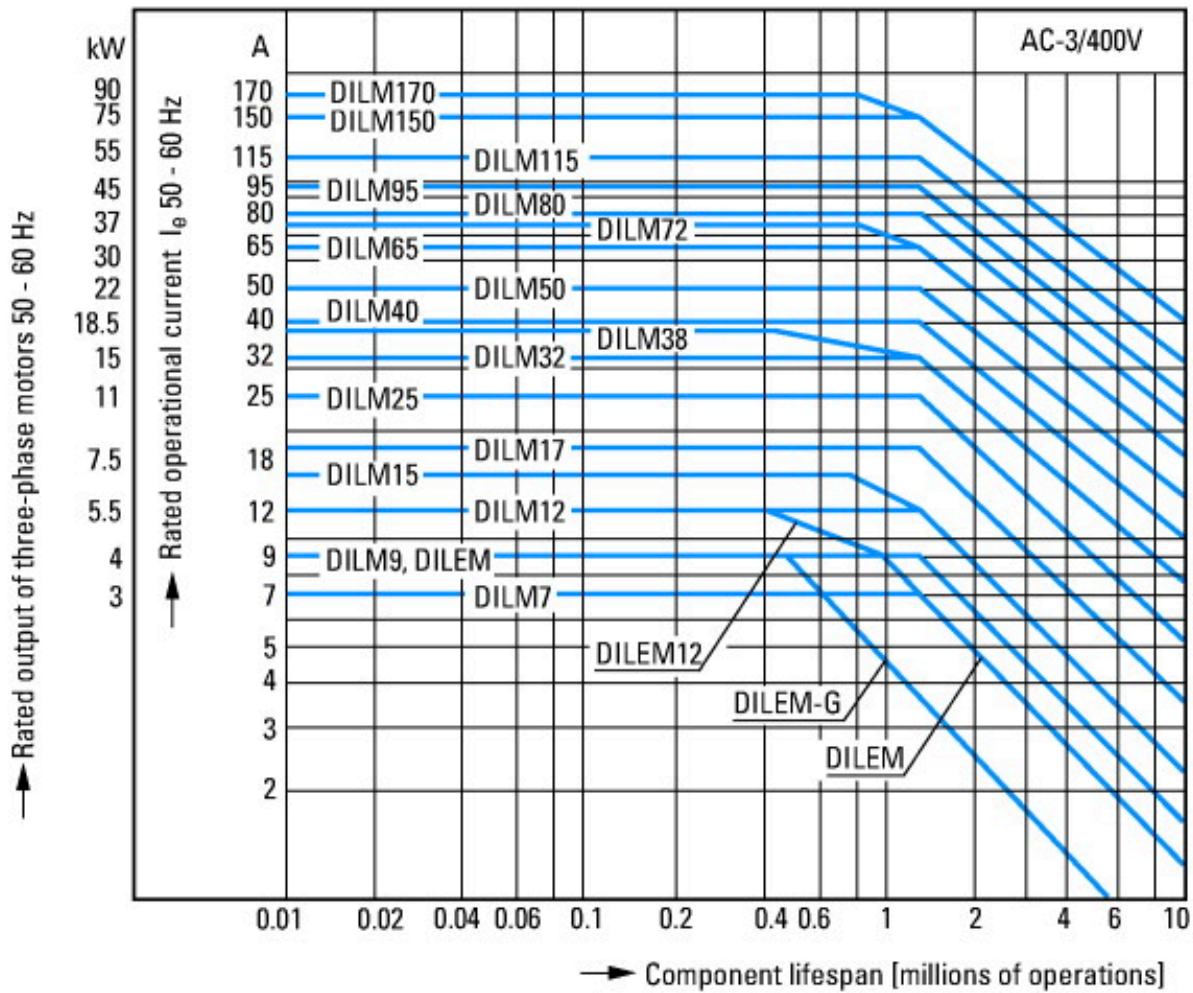

- Squirrel-cage motor
- Operating characteristics
- Starting: from rest
- Stopping: after attaining full running speed
- Electrical characteristics
- Make: up to 6 x rated motor current
- Break: up to 1 x rated motor current
- Utilization category
- 100 % AC-3
- Typical applications
- Compressors
- Lifts
- Mixers
- Pumps
- Escalators
- Agitators
- Fans
- Conveyor belts
- Centrifuges
- Hinged flaps
- Bucket-elevators
- Air conditioning system
- General drives in manufacturing and processing machines

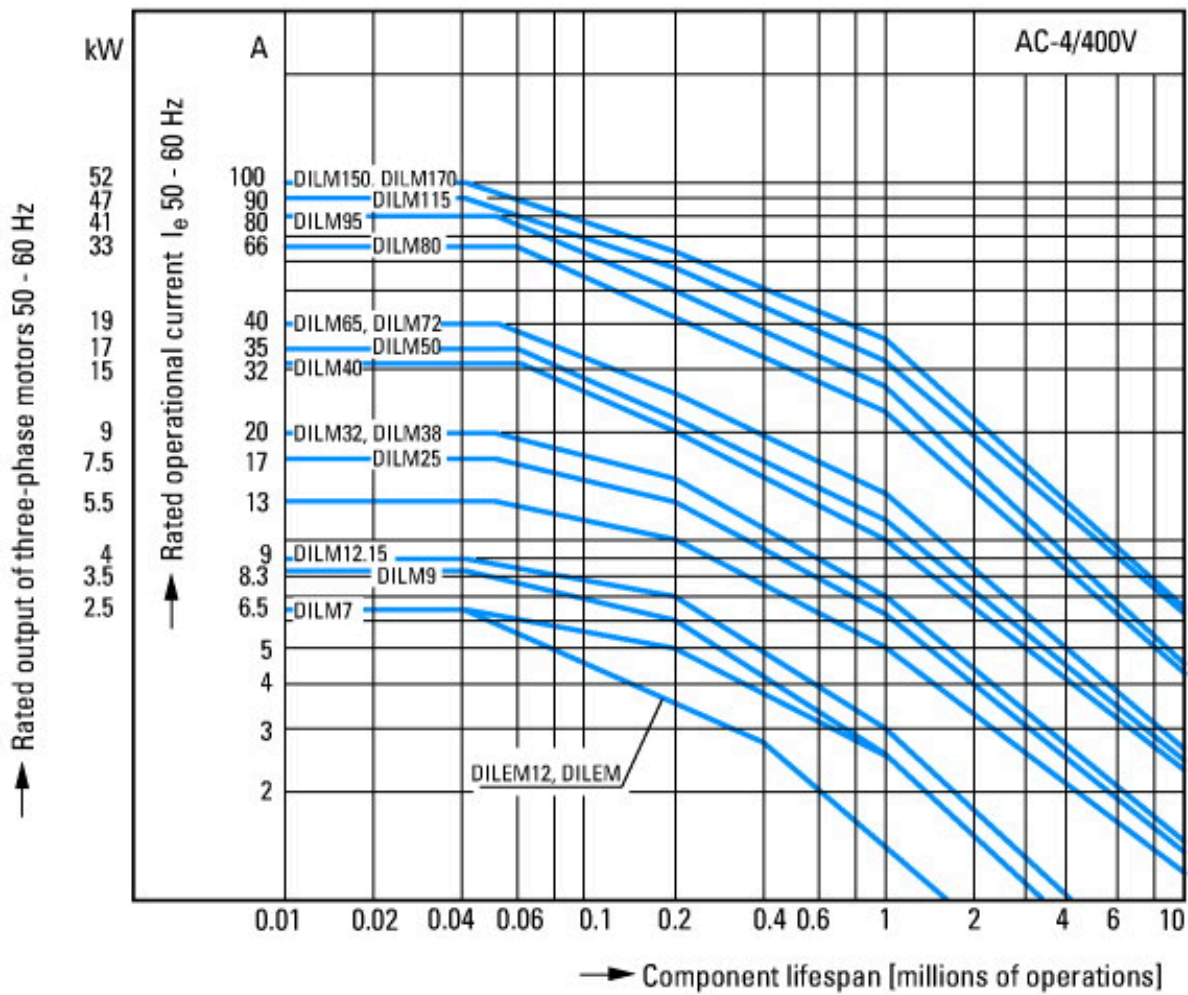

- Extreme switching duty
- Squirrel-cage motor
- Operating characteristics
- Inching, plugging, reversing
- Electrical characteristics
- Make: up to 6 x rated motor current
- Break: up to 6 x rated motor current
- Utilization category
- 100 % AC-4
- Typical applications
- Printing presses
- Wire-drawing machines
- Centrifuges
- Special drives for manufacturing and processing machines

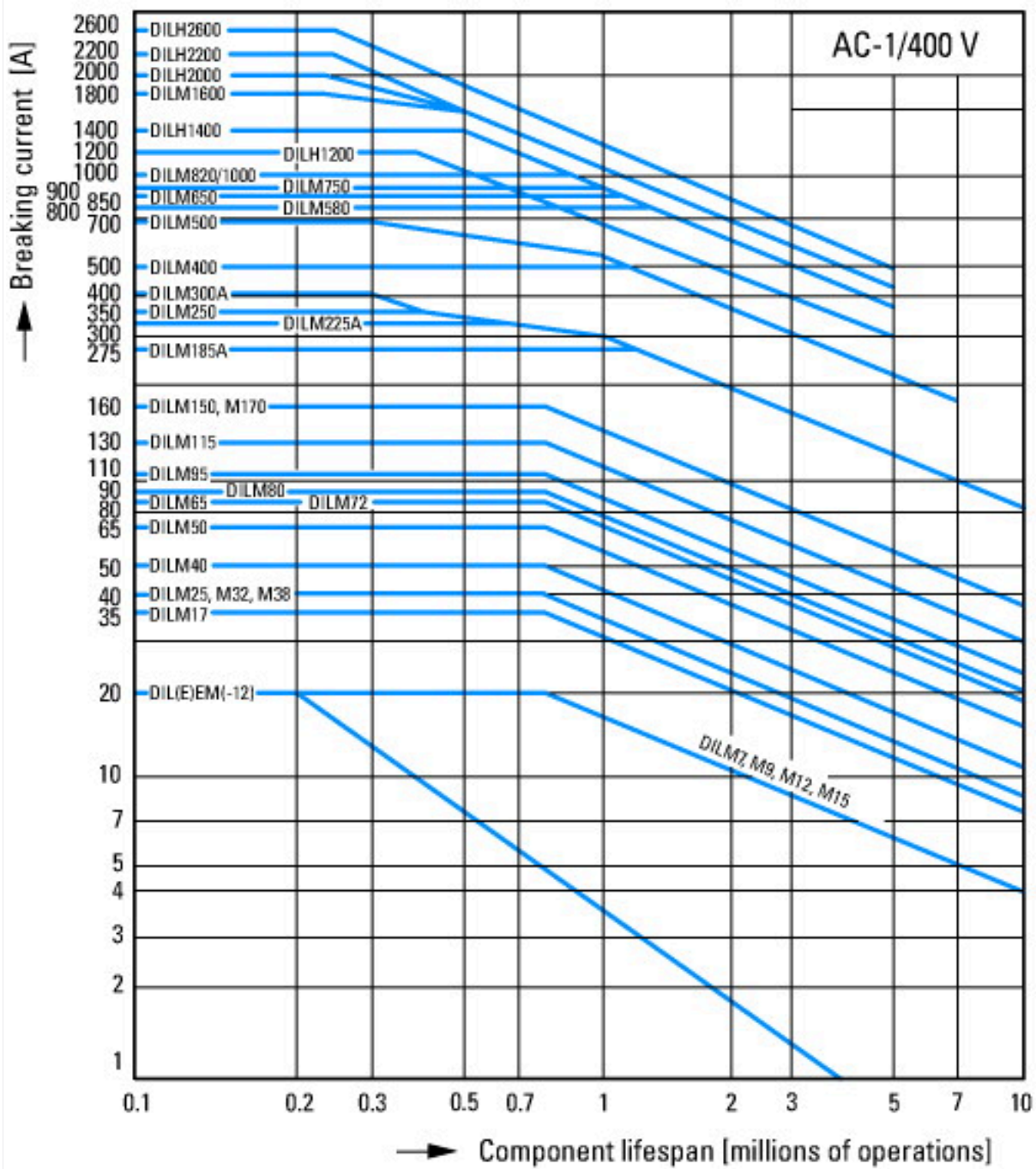

Switching duty for non-motor loads, 3-pole, 4-pole
 Operating characteristics
 Non-inductive or slightly inductive loads
 Electrical characteristics
 Make: 1 x rated current
 Break: 1 x rated current
 Utilization category
 100 % AC-1
 Typical applications
 Electric heat

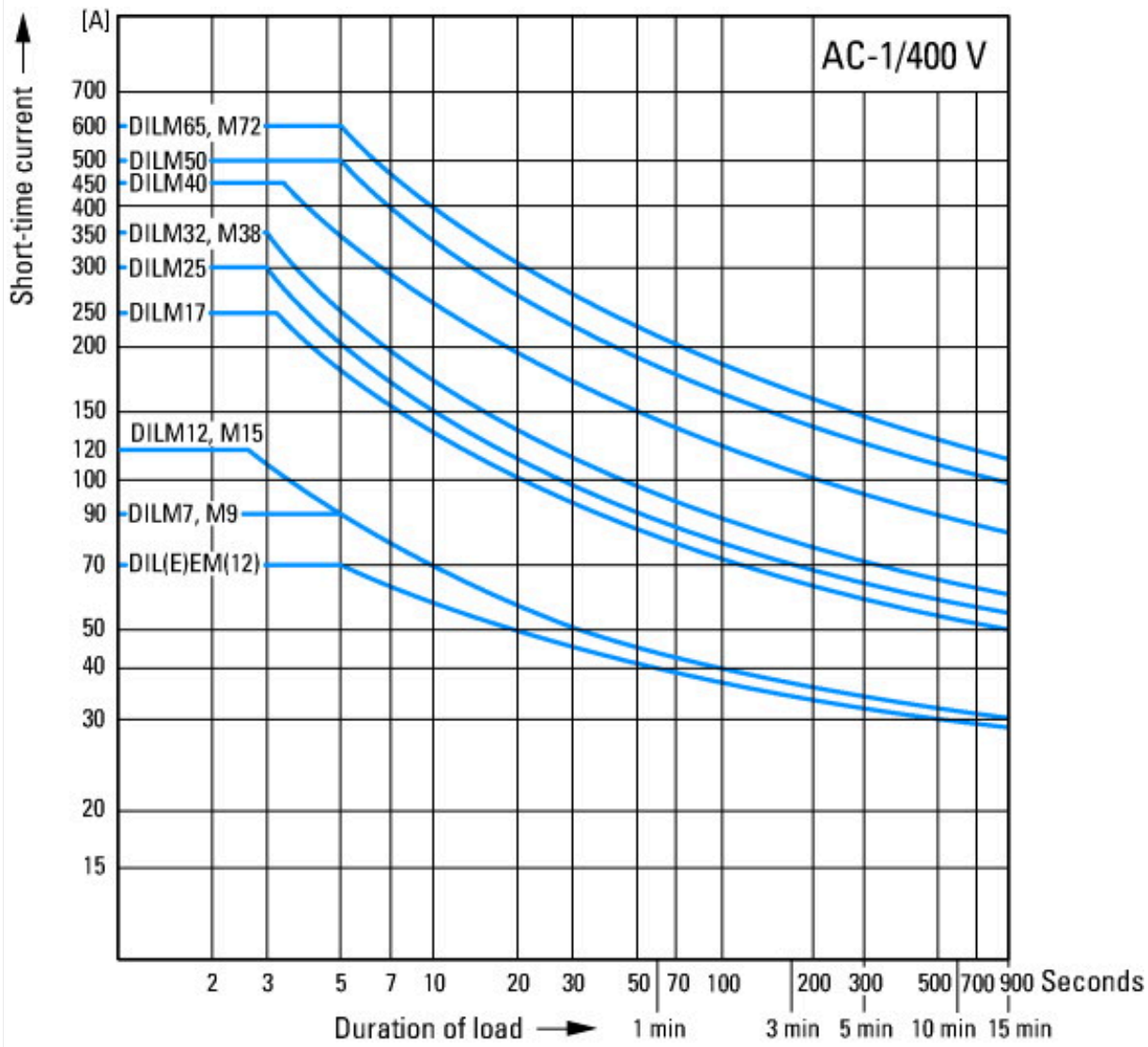

Short-time loading, 3-pole
 Time interval between two loading cycles: 15 minutes

Dimensions

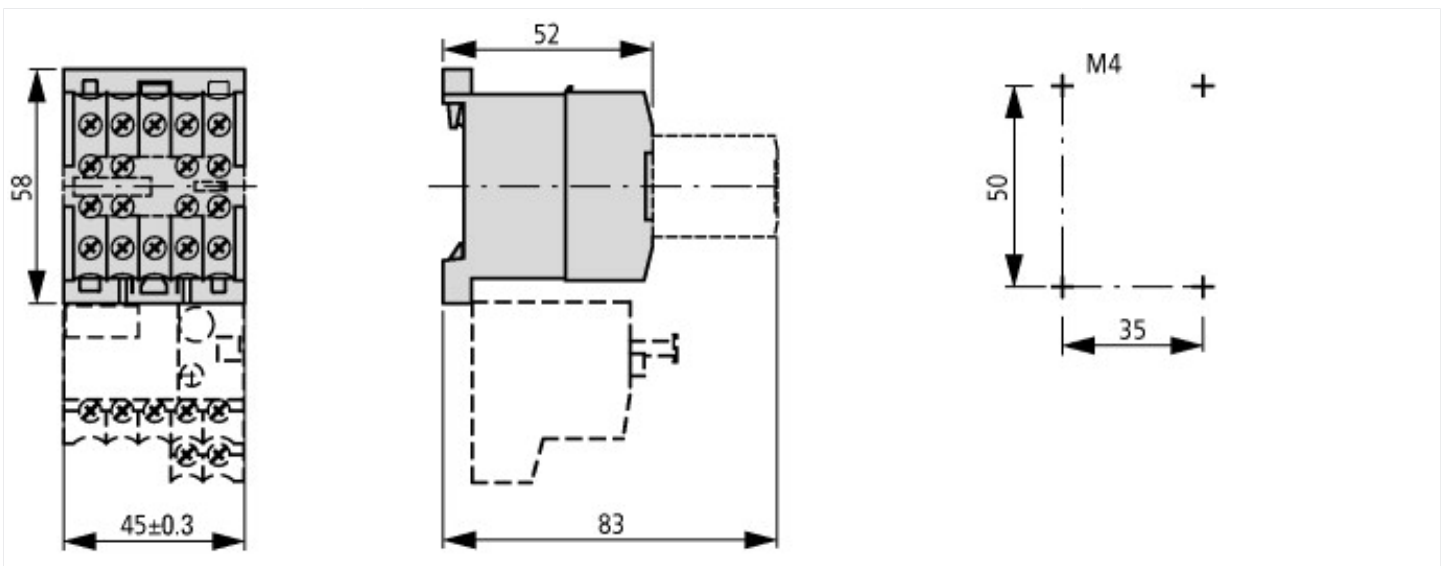

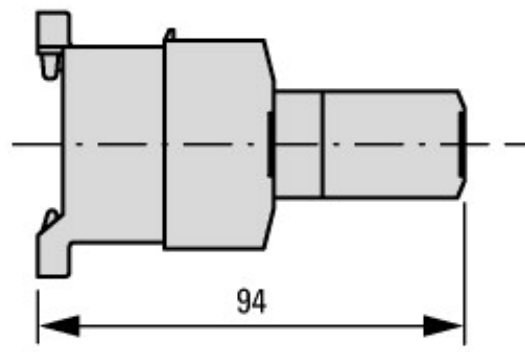
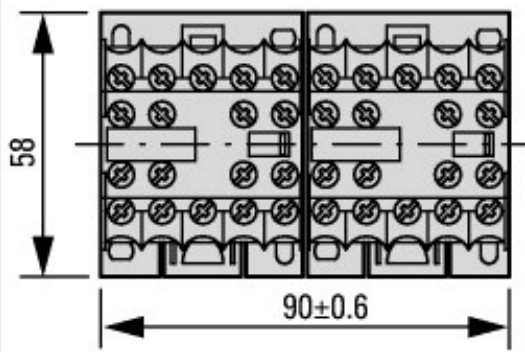

2DILE-... + MVDILE + ...DILE
 2DILE-...-G + MVDILE + ...DILE

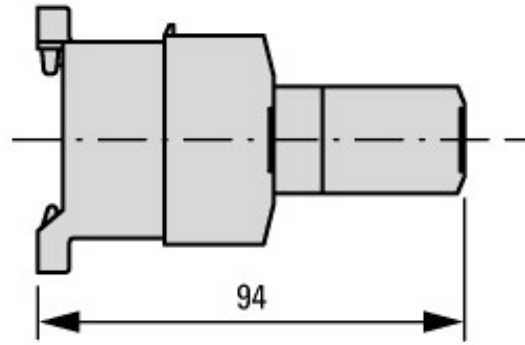
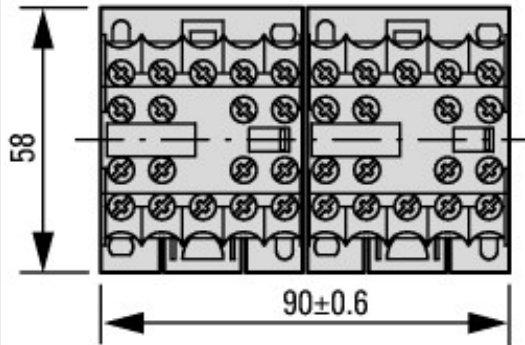

2DILE-... + MVDILE + ...DILE
 2DILE-...-G + MVDILE + ...DILE

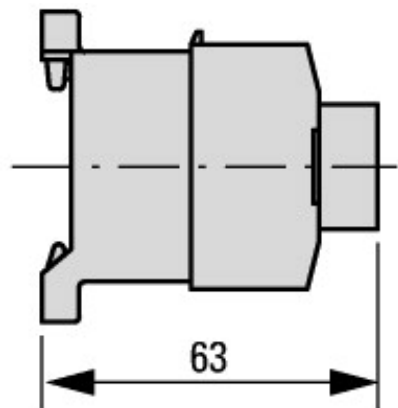
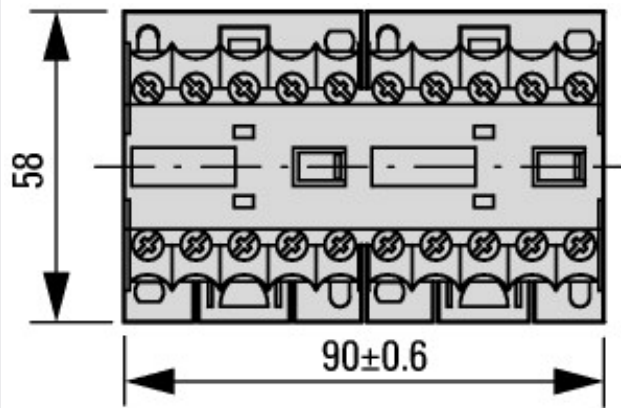

2DILE-... + MVDILE
 2DILE-...-G + MVDILE

Assets (links)

[Declaration of CE Conformity](#)

00003110

[Instruction Leaflets](#)

IL03407009Z2018_04