

Provides a superior operational feel with high-speed tracking in motor drive mode

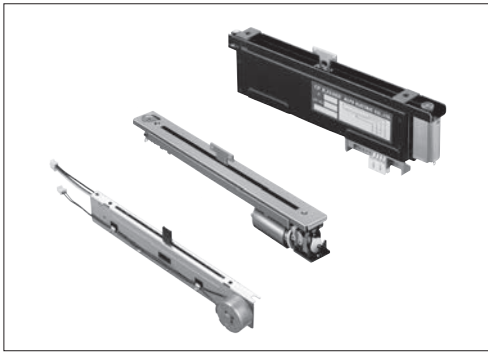

■ Typical Specifications



Items	Specifications		
	Motor N fader	Motor K fader	Motor V fader
Total resistance tolerance	±20%		
Maximum operating voltage	10V DC, 200V AC (Travel:60mm) 10V DC, 500V AC (Travel:100mm)		
Operating force	0.8±0.5N	0.4±0.25N	—
Operating life	30,000 cycles	300,000 cycles	100,000 cycles
Rated voltage of motor	10V DC		8V DC
Maximum current of motor	800mA or less (at 10V DC)		625mA or less (at 5V DC)
Operating temperature range	-10°C to +60°C		

■ Product Line

Number of resistor elements	Travel (mm)	Type	Lever type	Length of lever (mm)	Total resistance (kΩ)	Resistance taper	Terminal style	Touch sense track	Minimum order unit (pcs.)		Products No.	Drawing No.
									Japan	Export		
Single-unit	60	Motor N Fader	9-T (T-bar)	8.2	10	1B	Lead	With	200	400	RS60N11M9A0E	1
							For PC board (for auto dipping)		120	240	RS60N11M9A0F	2
	Lead						100		200	RSA0N11M9A0K	3	
	For PC board (for auto dipping)						80		160	RSA0N11M9A0J	4	
	100	Motor K Fader (CP type)	—	10.95	10	1B	Connector	Without	42	84	RSA0K11V901S	5
		Motor V Fader							80	80	RSA0V11M9001	6

Note

Other varieties are also available. Refer to "Other Specifications" (P.423).

■ Packing Specifications

Bulk/Tray

Product No.	Terminal style	Packing specifications	Number of packages (pcs.)		Export package measurements (mm)
			1 case /Japan	1 case /export packing	
RS60N	Lead	Tray	200	400	370×520×270
	For PC board		120	240	375×285×393
RSA0N	Lead		100	200	455×578×175
	For PC board		80	160	375×285×393
RSA0K	Connector	Bulk	42	84	370×520×201
RSA0V		Tray	80	80	524×344×173

Refer to P.423 for other specifications.
 Refer to P.423 for details of lever types.
 Refer to P.424, 425 for ordering products not listed.
 Refer to P.426 for soldering conditions.

■ Dimensions

Unit:mm

No.	Style
1	<p>Technical drawing of potentiometer style 1. It includes a top view with dimensions 54, 80, 52.5, and 2-M3. A side view shows a length of 60, a distance of 18.5 from the end to the center, and a height of 8.2. A terminal view shows a terminal height of 1.5 and a distance of 18.5 from the center to the terminal, with a hole diameter of 8. A detail view shows a 4mm wide terminal with a height of 8.2 and a thickness of 1.5. A bottom view shows terminal positions labeled 1, 2, 3, T, A, and B. The thickness is noted as t=1.2.</p>
2	<p>Technical drawing of potentiometer style 2. It includes a top view with dimensions 54, 80, 52.5, and 2-M3. A side view shows a length of 60, a distance of 18.5 from the end to the center, and a height of 8.2. A terminal view shows a terminal height of 1.5 and a distance of 18.5 from the center to the terminal, with a hole diameter of 8. A detailed PC board mounting hole diagram shows a 2-ø2 hole and a 6-ø1.5 hole with dimensions 11.25, 3.75, 36.65, 43.65, 9.55, and 8.2. The thickness is noted as t=1.2. The terminal is labeled 'L:Lug terminal'.</p>
3	<p>Technical drawing of potentiometer style 3. It includes a top view with dimensions 74, 120, 72.5, and 2-M3. A side view shows a length of 100, a distance of 18.5 from the end to the center, and a height of 8.2. A terminal view shows a terminal height of 1.5 and a distance of 18.5 from the center to the terminal, with a hole diameter of 8. A bottom view shows terminal positions labeled 1, 2, 3, T, A, and B. The thickness is noted as t=1.2.</p>

Rotary Potentiometers

Slide Potentiometers

General-use

Mixer

■ Dimensions

Unit:mm

No.	Style	PC board mounting hole dimensions (Viewed from mounting side)
4		<p>L:Lug terminal</p>
5	<p>Terminal No. A B ③ ① ② ①</p>	
6	<p>① BLACK ② WHITE ③ RED A RED B BLACK</p>	

Motor-driven Master Type / Other Specifications

In addition to the products listed, we can accommodate the follow specifications.

Products Specifications

Type	Travel (mm)	Model	Operating force	Touch sense track	Terminal	
Single-unit	60	RS60N11M	0.8±0.5N	Available	For PC board (for auto dipping) Lead	
	100	RSA0N11M				
Motor K fader CP type		100	RSA0K11V		0.4±0.25N	Fader terminal: Connector Motor terminal: Lead
Dual-unit (Servo + Audio track)	60	RS60N12M	0.8±0.5N		Lead	
	100	RSA0N12M				
		Motor N fader	100			RSA0K12V
	Motor K fader CP type					

Lever Types

Configuration code	9-T (T-Bar)
Dimensions	

Total Resistance Variety

Total resistance (k Ω)	10*	50	100	250

* Motor K fader, Motor V fader: Only 10kΩ

Resistance Taper

Resistance taper	Servo	1B		
	Audio	15A	1B	10A

Circuit Diagram

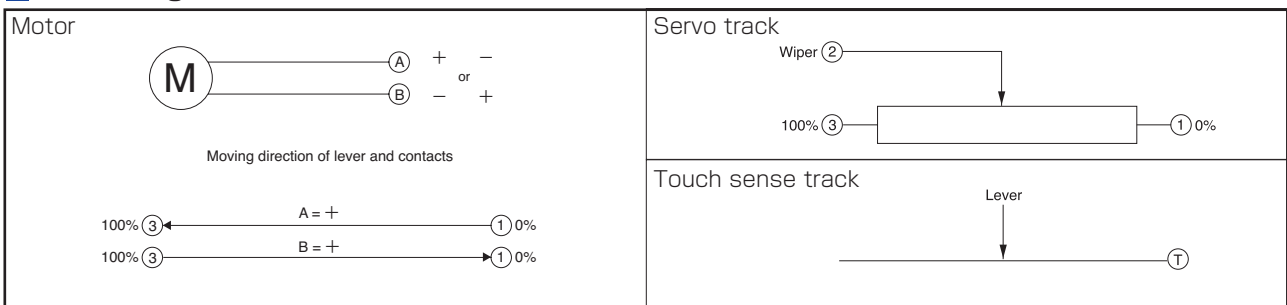

Note

Marked are specifications recommended by Alps.

When ordering product varieties that are not listed, specify referring to the examples below.

Sample Part Number

R S 6 0 N 1 1 M T 0 B 1 0 3

Travel (mm)

60	60
A0	100

Number of resistor elements

Single-unit	1
Dual-unit	2

Touch sense track

Code	Touch sense track
T0	Without
T1	With

Resistance taper

Code	Resistance taper
B	1B
A	15A
D	10A

For dual-units specify the taper of the audio track. Servo track will always be 1B taper.

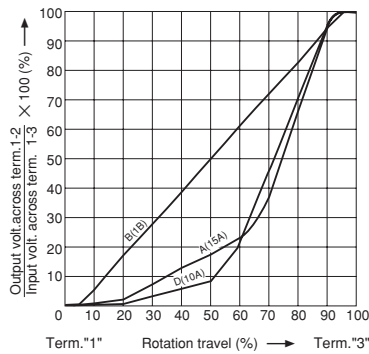

Total resistance

Code	Total resistance (k Ω)
103	10
503	50
104	100
254	250

Note

Marked are specifications recommended by Alps.

Potentiometers
 Rotary
 Potentiometers
 Slide
 Potentiometers
 General-Use
 Mixer

Motor-driven Master Type (Motor K Fader) / Ordering Products Not Listed

When ordering product varieties that are not listed, specify referring to the examples below.

■ Sample Part Number

R S A 0 K 1 1 V - T 0 - B 1 0 3

Number of resistor elements

Single-unit	1
Dual-unit	2

Type

CP type	V
---------	---

Touch sense track

Code	Touch sense track
T0	Without
T1	With

Resistance taper

Code	Resistance taper
B	1B
A	15A
D	10A

Appoint the taper of audio track in the case of dual-unit.
Servo track is surely 1B taper.

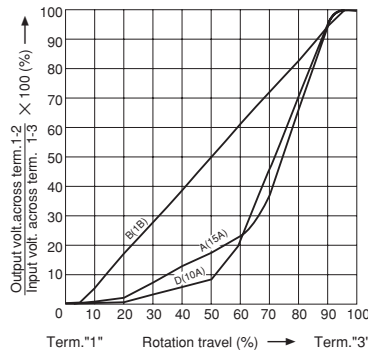

Total resistance

Code	Total resistance (k Ω)
103	10

Note

Marked are specifications recommended by Alps.

Rotary
Potentiometers













Slide
Potentiometers

General-use

Mixer

Slide Potentiometers

List of Varieties

Type		Low-profile master type			Motor-driven master type		
Series		N Fader	Slim Type	Super P Fader	Motor N Fader	Motor K Fader	Motor V Fader
		RS □□ N	RS □□ N1S	RS6011 □ P	RS □□ N1 □ M	RSA0K1 □ V	RSA0V11M
		Single-unit/Dual-unit	Single-unit	Single-unit/Dual-unit	Single-unit/Dual-unit	Single-unit/Dual-unit	Single-unit
Photo							
Travel (mm)		60, 100		60	60, 100	100	100
Direction of lever		Vertical					
Lever material		Metal					Resin
Operating temperature range		-10°C to +60°C					
Operating life		30,000 cycles			30,000 cycles	300,000 cycles	100,000 cycles
Available for automotive use		—	—	—	—	—	—
Life cycle							
Electrical performance	Total resistance (k Ω)	10, 50, 100, 250		10, 20, 50	10, 50, 100, 250	10	10
	Resistance taper	15A, 1B, 10A			Single-unit: 1B Dual-unit: Servo 1B Audio 15A, 1B, 10A		1B
	Rated Power	0.1W (RS60N) 0.25W (RSA0N)	0.2W (RS60N11S) 0.5W (RSA0N11S)	0.2W (Single-unit) 0.1W (Dual-unit)	0.2W (RS60N1□M) 0.5W (RSA0N1□M)	0.5W	
	Insulation resistance	100MΩ min. 250V DC					
	Voltage proof	250V AC for 1 minute					
	Center-taps	Without					
Mechanical performance	Operating force	Single-unit: 0.3 ^{+0.5} _{-0.25} N Dual-unit: 0.4 ^{+0.5} _{-0.35} N	0.3 ^{+0.5} _{-0.25} N	0.5 ^{+1.0} _{-0.4} N	0.8±0.5N	Single-unit: 0.4±0.25N Dual-unit: 0.25 to 0.9N	—
	Center detent	Without					
	Stopper strength	100N					10N
	Lever push-pull strength	50N					5N
	Lever wobble (mm) * Both sides	$\frac{2(2 \times L)}{25}$					
	Lever deviation (mm)	0.5 max. (One side)					
Terminal style		Insertion			Lead, Insertion	Connector(Fader) Lead (Motor)	Connector
Page		410	414	417	420		

Slide Potentiometers Soldering Conditions	426
Potentiometer Cautions	427
Potentiometers Measurement and Test Methods	429
Potentiometers Resistance Taper	431

Notes

- Attenuation is specified for residual resistance.
- "L" in the "Lever Wobble" column of the above table indicates the length of lever.

Reference for Manual Soldering

Series	Tip temperature	Duration of Soldering time	No. of solders
RS□□1, RS□□H, RS08U, RS□□K (Standard), RS□□N, RS□□N11S, RS6011□P, RS□□N1□M, RSA0K1□V (Motor terminal)	350°C max.	3s max.	1 time

Reference for Dip Soldering

Series	Preheating		Dip soldering		Number of soldering
	Soldering surface temperature	Heating time	Soldering temperature	Soldering time	
RS□□1, RS□□H, RS□□N, RS□□N11S, RS6011□P, RS□□N1□M	100°C max.	1 min. max.	260°C	5s max.	1 time

Example of Reflow Soldering Condition

Temperature profile

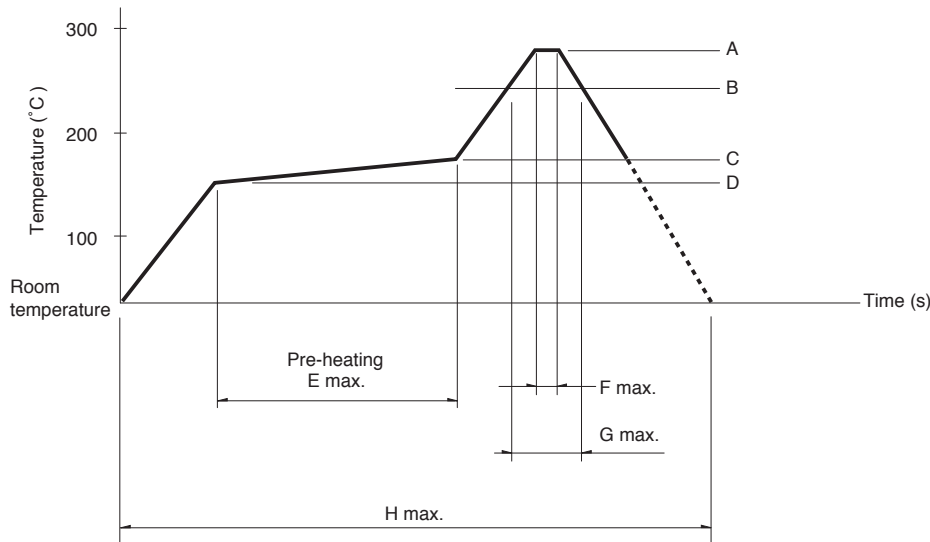

Series	A	B	C	D	E	F	G	H	No. of reflows
RS08U	250°C	200°C	150°C	150°C	2 min.	3s	40s	4 min.	1 time

Notes

1. When using an infrared reflow oven, solder may sometimes not be applied. Be sure to use a hot air reflow oven or a type that uses infrared rays in combination with hot air.
2. The temperatures given above are the maximum temperatures at the terminals of the potentiometer when employing a hot air reflow method. The temperature of the PC board and the surface temperature of the potentiometer may vary greatly depending on the PC board material, its size and thickness. Ensure that the surface temperature of the potentiometer does not rise to 250°C or greater.
3. Conditions vary to some extent depending on the type of reflow bath used. Be sure to give due consideration to this prior to use.