

IA series

Low profile pushbutton switches

Distinctive features - Specifications - Overview

- Resistant to frost, sand and hydrocarbons
- Tactile feedback
- Front panel sealed to IP 67

ELECTRICAL AND GENERAL SPECIFICATIONS

- Max. current/voltage rating with resistive load : 2A 24VDC
- Initial contact resistance : 100mΩ max.
- Insulation resistance : 100 MΩ min. at 500VDC
- Dielectric strength : 1.000 VAC rms
- Electrical life at full load : 1 000.000 cycles
- Panel thickness : 7 mm (.276) max.
- Total travel : 1,5 mm +/- 0,3 (.059 +/- .012)
- Operating force : 6,5 N ±2N

MATERIALS

- Case/bushing : thermoplastic
- Actuator : polyurethane
- Contacts : silver
- Terminal seal : epoxy

ENVIRONMENTAL SPECIFICATIONS

- Front panel sealing (see drawings opposite) :
 - With O-ring above the panel : IP67
 - With O-ring under the panel : IP64
- Operating temperature : -20°C to +65°C

PANEL MOUNTING

→ O-ring

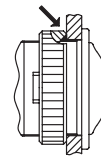

Sealing to IP64

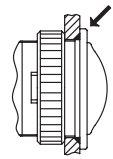

Sealing to IP67

IA							
SERIES	Shape	Electrical function	Terminals	Contacts	Plunger colours	Case colour	
	R round	3 Normally open (NO) 5 NC/NO combined	F Wire leads	1 Silver	1 Blue 2 Black 3 Green 5 Yellow 6 Red 7/1 White 9 Orange	00 Black	

Dimensions : First dimensions are in mm while inches are shown as bracketed numbers.



Mounting accessories : Standard hardware supplied : 1 knurled nut and 1 O-ring



Packaging unit : 25 pieces

IA series

Low profile pushbutton switches

Bushing $\varnothing 16 (.629)$

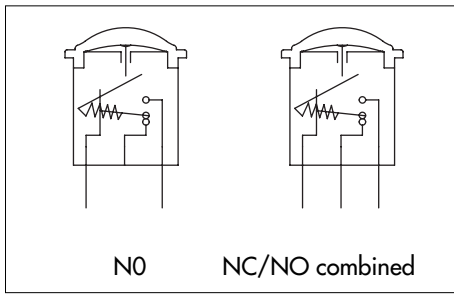

- Panel cut-out $\varnothing 16,2 \text{ mm} (.657)$
- Min. pitch for matrix mounting : $20 \times 20 \text{ mm} (.787 \times .787)$

MODEL STRUCTURE

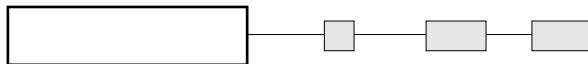

NO model has 2 terminals only.

Models



Normally open
IAR3F



NC/NO combined
IAR5F

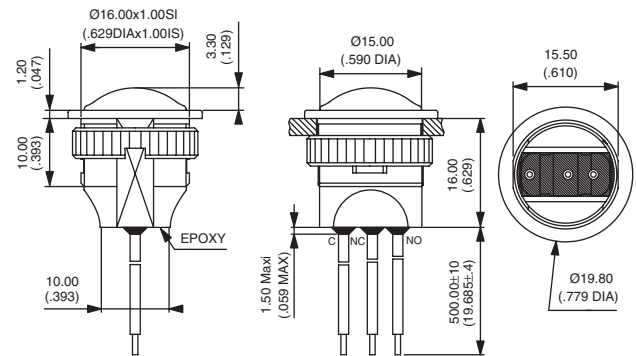

Wire colours (NC/NO) : black = common, brown = NC, blue = NO

CONTACT MATERIAL

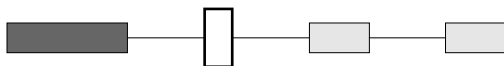

1 Silver

PLUNGER COLOUR

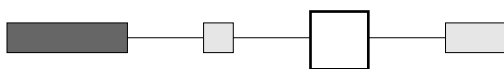

1 : blue - 2 : black - 3 : green - 5 : yellow - 6 : red - 7/1 : white - 9 : orange

CASE COLOUR

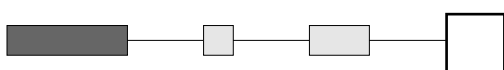

00 : black