

Surface Mount General Purpose Silicon Rectifiers

Reverse Voltage - 50 to 1000 V

Forward Current - 2 A

FEATURES

- For surface mounted applications
- Low profile package
- Glass Passivated Chip Junction
- Easy to pick and place
- Lead free in comply with EU RoHS 2011/65/EU directives

MECHANICAL DATA

- Case: SMAF
- Terminals: Solderable per MIL-STD-750, Method 2026
- Approx. Weight: 27mg 0.00086oz

Maximum Ratings and Electrical characteristics

Ratings at 25°C ambient temperature unless otherwise specified. Single phase half-wave 60 Hz, resistive or inductive load, for capacitive load current derate by 20 %.

PINNING

PIN	DESCRIPTION
1	Cathode
2	Anode

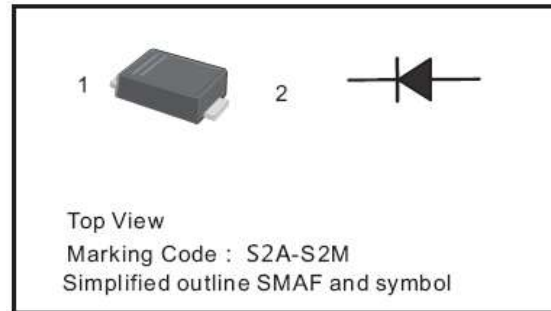

Parameter	Symbols	S2AF	S2BF	S2DF	S2GF	S2JF	S2KF	S2MF	Units
Maximum Repetitive Peak Reverse Voltage	V_{RRM}	50	100	200	400	600	800	1000	V
Maximum RMS voltage	V_{RMS}	35	70	140	280	420	560	700	V
Maximum DC Blocking Voltage	V_{DC}	50	100	200	400	600	800	1000	V
Maximum Average Forward Rectified Current at $T_a = 65^\circ\text{C}$	$I_{F(AV)}$	2							A
Peak Forward Surge Current 8.3 ms Single Half Sine Wave Superimposed on Rated Load (JEDEC Method)	I_{FSM}	60							A
Maximum Instantaneous Forward Voltage at 2 A	V_F	1.1							V
Maximum DC Reverse Current at Rated DC Blocking Voltage $T_a = 25^\circ\text{C}$ $T_a = 125^\circ\text{C}$	I_R	5 50							μA
Typical Junction Capacitance ¹⁾	C_j	30							pF
Typical Thermal Resistance ²⁾	$R_{\theta JA}$	50							$^\circ\text{C/W}$
Operating and Storage Temperature Range	T_j, T_{stg}	-55 ~ +150							$^\circ\text{C}$

1) Measured at 1 MHz and applied reverse voltage of 4 V D.C 2) Thermal resistance from junction to ambient at 0.375" (9.5 mm) lead length, P.C.B. mounted

SHIKE MAKE CONSCIOUS PRODUCT

CONSCIOUS PRODUCTS BEGIN WITH CONSCIOUS PEOPLE

REV.07



www.shike.tw

Fig.1 Forward Current Derating Curve

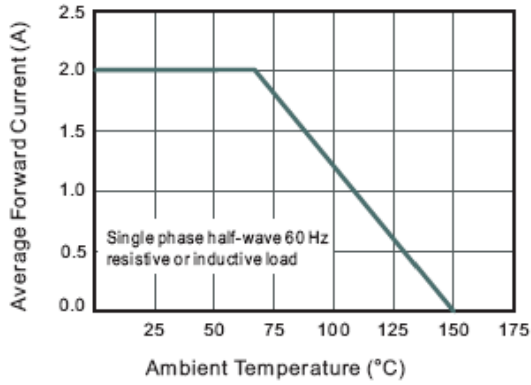

Fig.2 Typical Instantaneous Reverse Characteristics

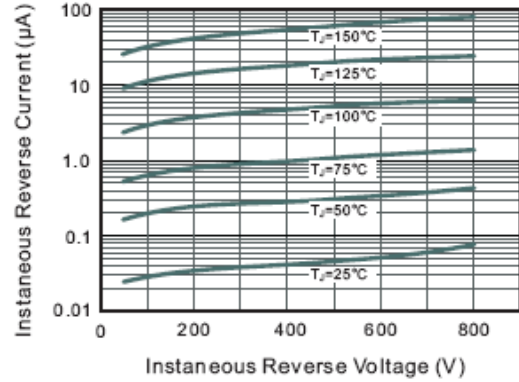

Fig.3 Typical Forward Characteristic

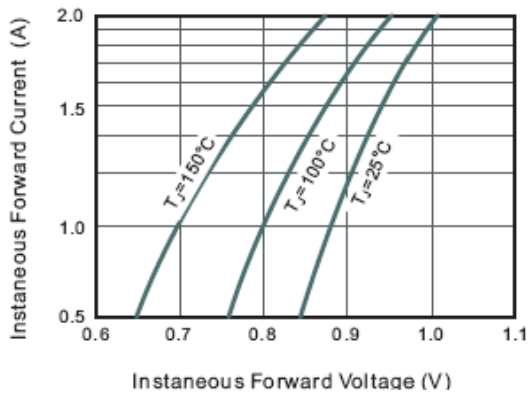
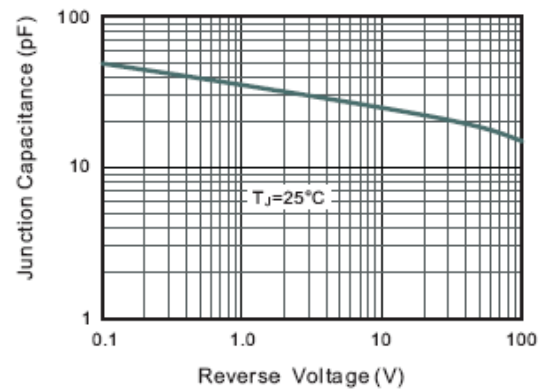

Fig.4 Typical Junction Capacitance



PACKAGE OUTLINE

Plastic surface mounted package; 2 leads

SMAF

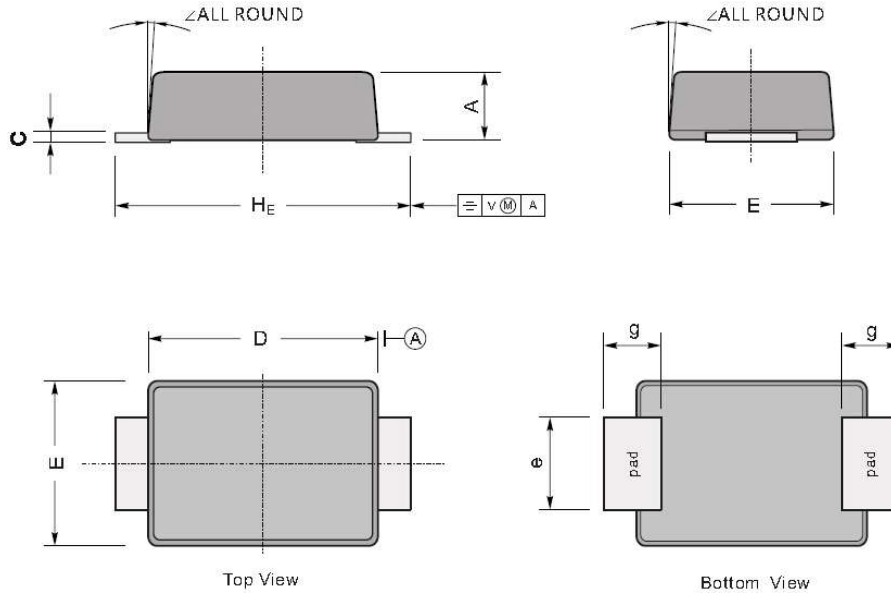

UNIT		A	C	D	E	e	g	H _E	∠
mm	max	1.1	0.20	3.7	2.7	1.6	1.2	4.9	7°
	min	0.9	0.12	3.3	2.4	1.3	0.8	4.4	
mil	max	43	7.9	146	106	63	47	193	
	min	35	4.7	130	94	51	31	173	

The recommended mounting pad size

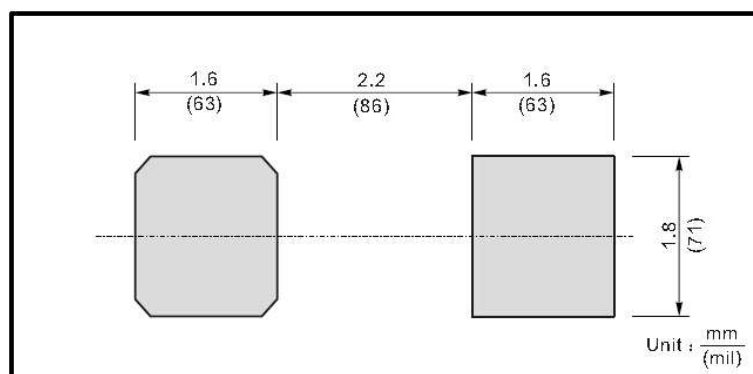

SHIKE MAKE CONSCIOUS PRODUCT

CONSCIOUS PRODUCTS BEGIN WITH CONSCIOUS PEOPLE

REV.07

