

### Features

- 85V/90A,  
 $R_{DS(ON)} = 5.8m\Omega(Typ.)@V_{GS}=10V$
- Ultra Low On-Resistance
- Fast Switching and Fully Avalanche Rated
- 100% avalanche tested
- 175°C Operating Temperature
- Lead Free and Green Devices Available (RoHS Compliant)

### Pin Description

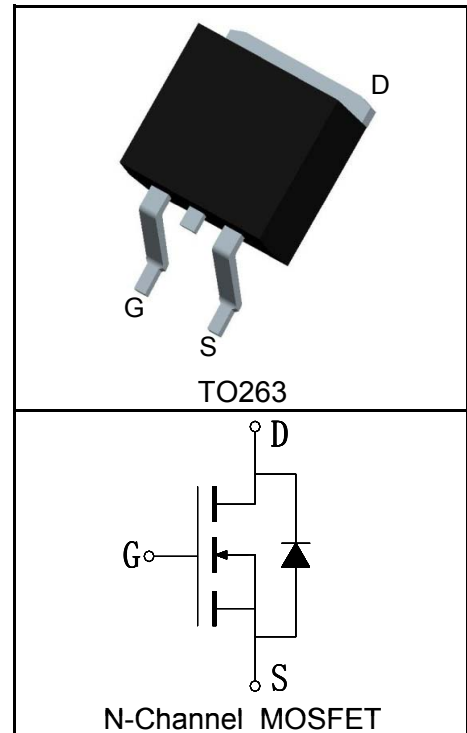

### Applications

- High Speed Power Switching
- UPS

### Absolute Maximum Ratings

Symbol	Parameter	Rating	Unit
<b>Common Ratings</b> ( $T_C=25^\circ C$ Unless Otherwise Noted)			
$V_{DSS}$	Drain-Source Voltage	85	V
$V_{GSS}$	Gate-Source Voltage	$\pm 25$	
$T_J$	Maximum Junction Temperature	175	$^\circ C$
$T_{STG}$	Storage Temperature Range	-55 to 175	$^\circ C$
$I_S$	Diode Continuous Forward Current	$T_C=25^\circ C$ 90	A
<b>Mounted on Large Heat Sink</b>			
$I_{DP}^{①}$	300 $\mu s$ Pulse Drain Current Tested	$T_C=25^\circ C$ 360	A
$I_D^{②}$	Continuous Drain Current( $V_{GS}=10V$ )	$T_C=25^\circ C$ 90	A
		$T_C=100^\circ C$ 64	
$P_D$	Maximum Power Dissipation	$T_C=25^\circ C$ 188	W
		$T_C=100^\circ C$ 94	
$R_{\theta JC}$	Thermal Resistance-Junction to Case	0.8	$^\circ C/W$
$R_{\theta JA}$	Thermal Resistance-Junction to Ambient	62.5	$^\circ C/W$
<b>Drain-Source Avalanche Ratings</b>			
$E_{AS}^{③}$	Avalanche Energy, Single Pulsed	306	mJ

**Electrical Characteristics** ( $T_C=25^\circ\text{C}$  Unless Otherwise Noted)

Symbol	Parameter	Test Condition	RU8590S			Unit
			Min.	Typ.	Max.	
<b>Static Characteristics</b>						
$BV_{DSS}$	Drain-Source Breakdown Voltage	$V_{GS}=0V, I_{DS}=250\mu A$	85	90		V
$I_{DSS}$	Zero Gate Voltage Drain Current	$V_{DS}=85V, V_{GS}=0V$			1	$\mu A$
		$T_J=125^\circ C$			30	
$V_{GS(th)}$	Gate Threshold Voltage	$V_{DS}=V_{GS}, I_{DS}=250\mu A$	2	3	4	V
$I_{GSS}$	Gate Leakage Current	$V_{GS}=\pm 25V, V_{DS}=0V$			$\pm 100$	nA
$R_{DS(ON)}^{(4)}$	Drain-Source On-state Resistance	$V_{GS}=10V, I_{DS}=45A$		5.8	8	m $\Omega$
<b>Diode Characteristics</b>						
$V_{SD}^{(4)}$	Diode Forward Voltage	$I_{SD}=45A, V_{GS}=0V$			1.2	V
$t_{rr}$	Reverse Recovery Time	$I_{SD}=45A, di_{SD}/dt=100A/\mu s$		29		ns
$Q_{rr}$	Reverse Recovery Charge			45		nC
<b>Dynamic Characteristics</b> <sup>(5)</sup>						
$R_G$	Gate Resistance	$V_{GS}=0V, V_{DS}=0V, F=1MHz$		1.3		$\Omega$
$C_{iss}$	Input Capacitance	$V_{GS}=0V,$ $V_{DS}=40V,$ Frequency=1.0MHz		4350		pF
$C_{oss}$	Output Capacitance			480		
$C_{riss}$	Reverse Transfer Capacitance			275		
$t_{d(ON)}$	Turn-on Delay Time	$V_{DD}=40V, I_{DS}=45A,$ $V_{GEN}=10V, R_G=0.8\Omega$		25		ns
$t_r$	Turn-on Rise Time			49		
$t_{d(OFF)}$	Turn-off Delay Time			121		
$t_f$	Turn-off Fall Time			17		
<b>Gate Charge Characteristics</b> <sup>(5)</sup>						
$Q_g$	Total Gate Charge	$V_{DS}=68V, V_{GS}=10V,$ $I_{DS}=45A$		48		nC
$Q_{gs}$	Gate-Source Charge			13		
$Q_{gd}$	Gate-Drain Charge			16		

- Notes:
- ① Pulse width limited by safe operating area.
  - ② Calculated continuous current based on maximum allowable junction temperature. The package limitation current is 75A.
  - ③ Limited by  $T_{Jmax}$ ,  $I_{AS}=35A$ ,  $V_{DD}=48V$ ,  $R_G=50\Omega$ , Starting  $T_J=25^\circ C$ .
  - ④ Pulse test; Pulse width  $\leq 300\mu s$ , duty cycle  $\leq 2\%$ .
  - ⑤ Guaranteed by design, not subject to production testing.

**Ordering and Marking Information**

<b>Device</b>	<b>Marking</b>	<b>Package</b>	<b>Packaging</b>	<b>Quantity</b>	<b>Reel Size</b>	<b>Tape width</b>
RU8590S	RU8590S	TO263	Tube	50	-	-

**Typical Characteristics**

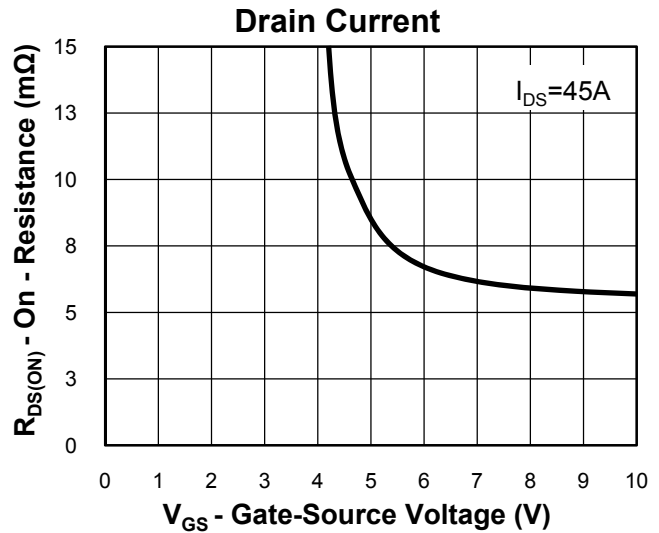
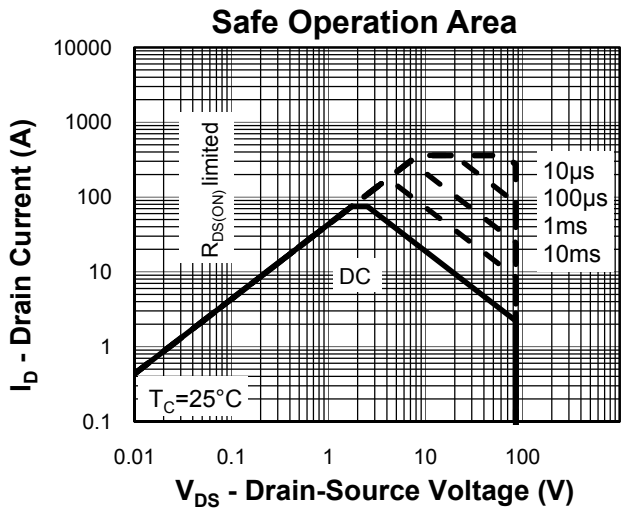
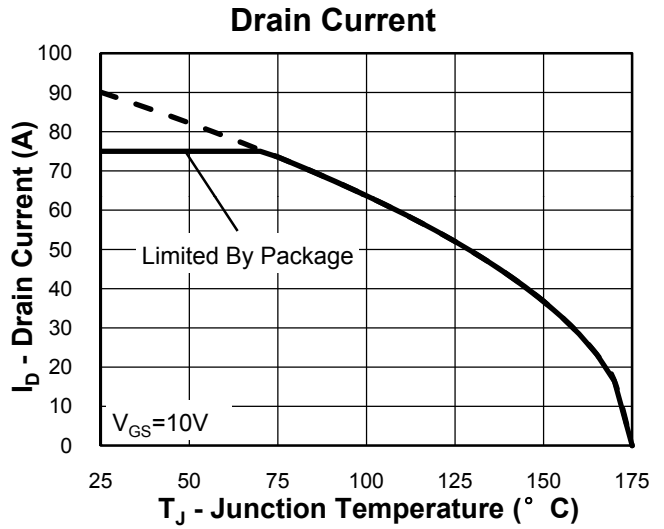
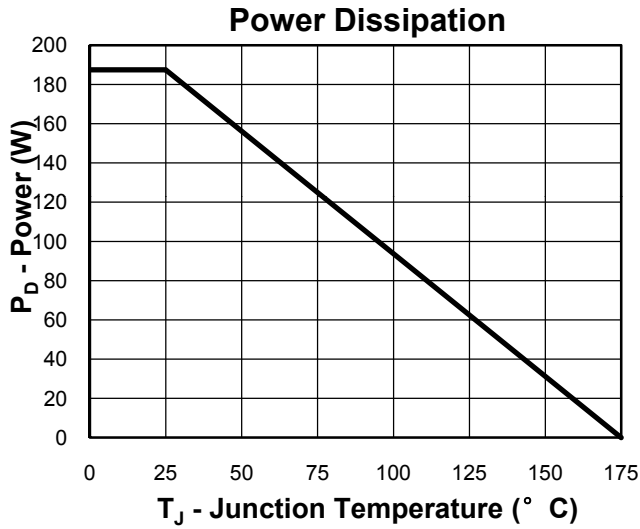

**Thermal Transient Impedance**

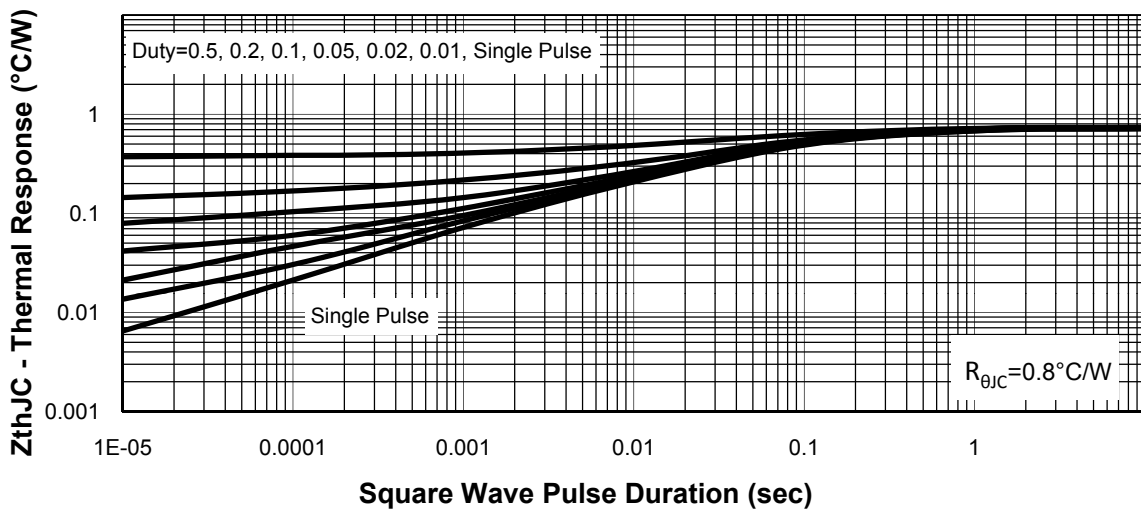

**Typical Characteristics**

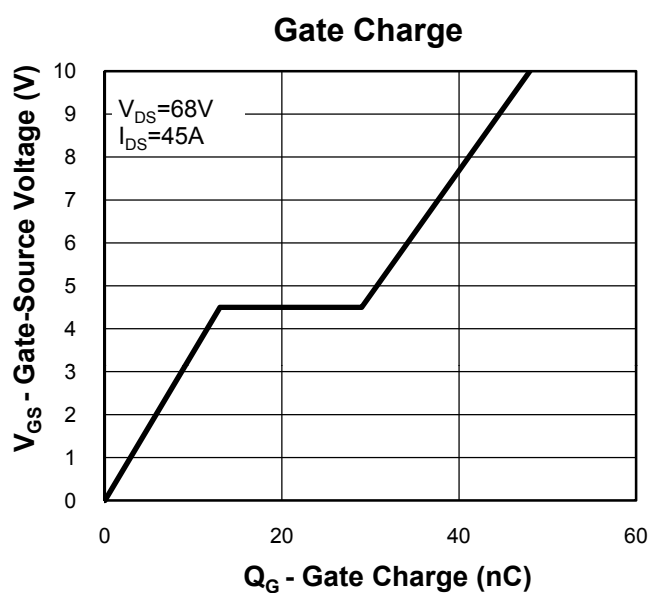
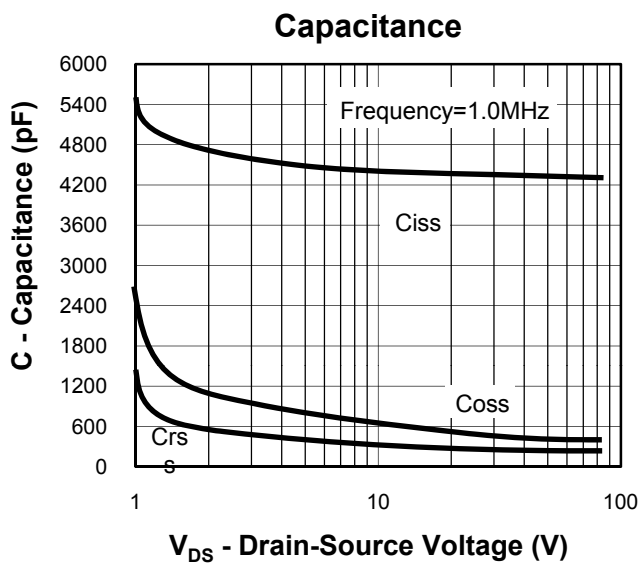
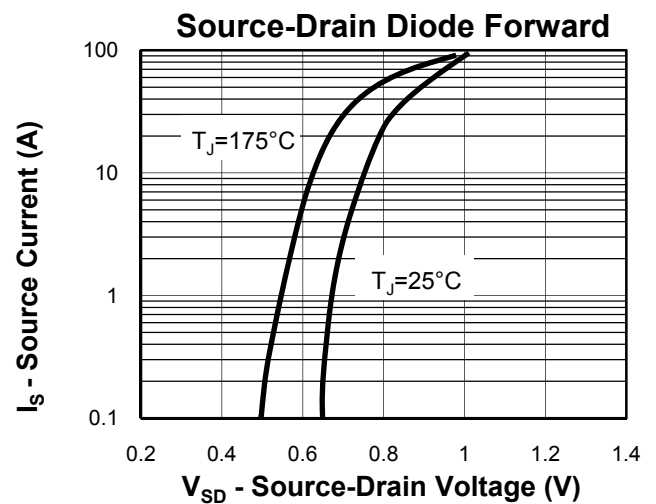
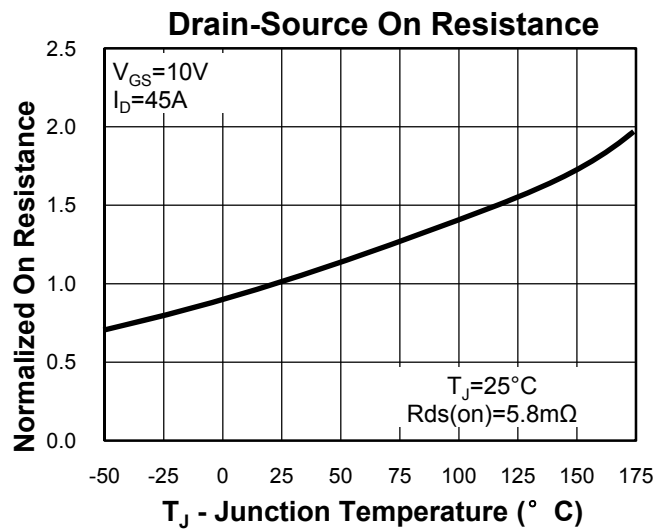
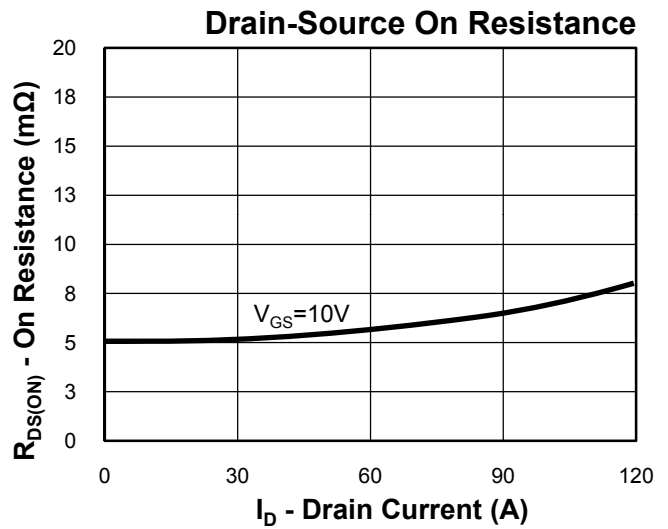
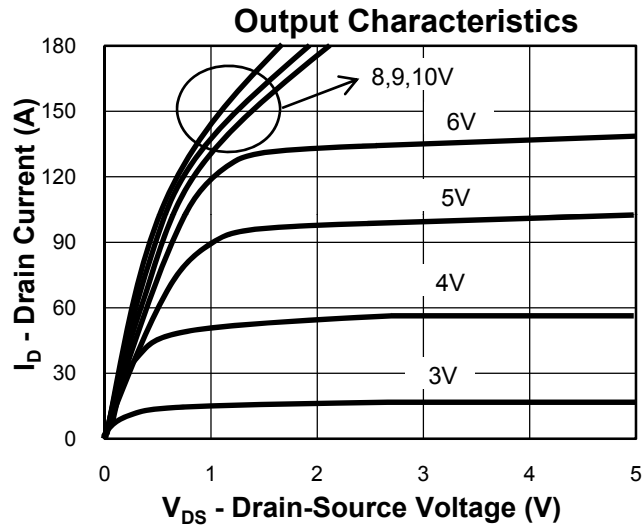

**Avalanche Test Circuit and Waveforms**

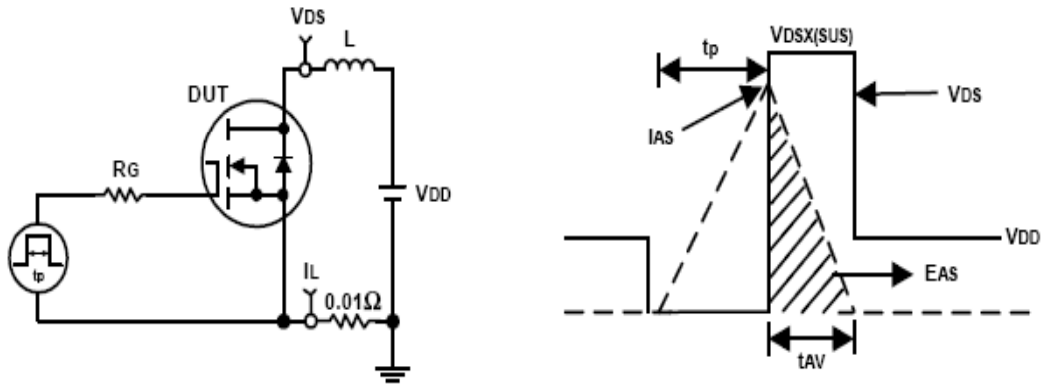

**Switching Time Test Circuit and Waveforms**

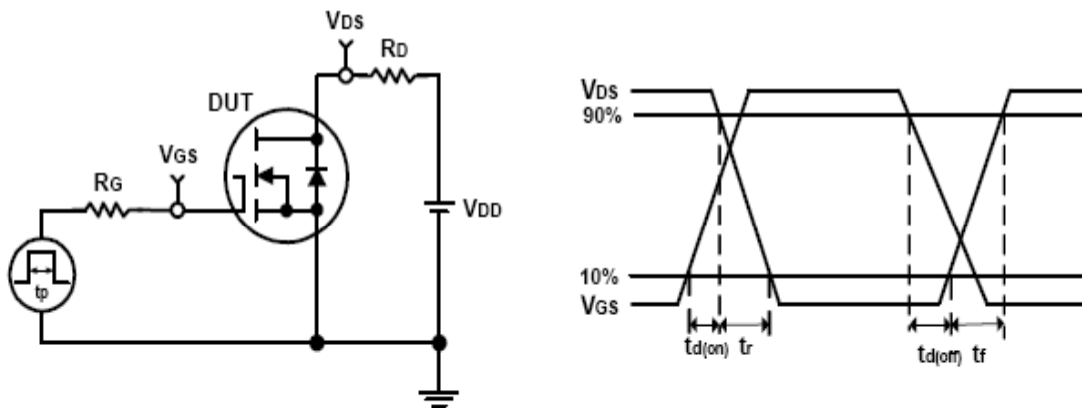

**Package Information**

**TO263**

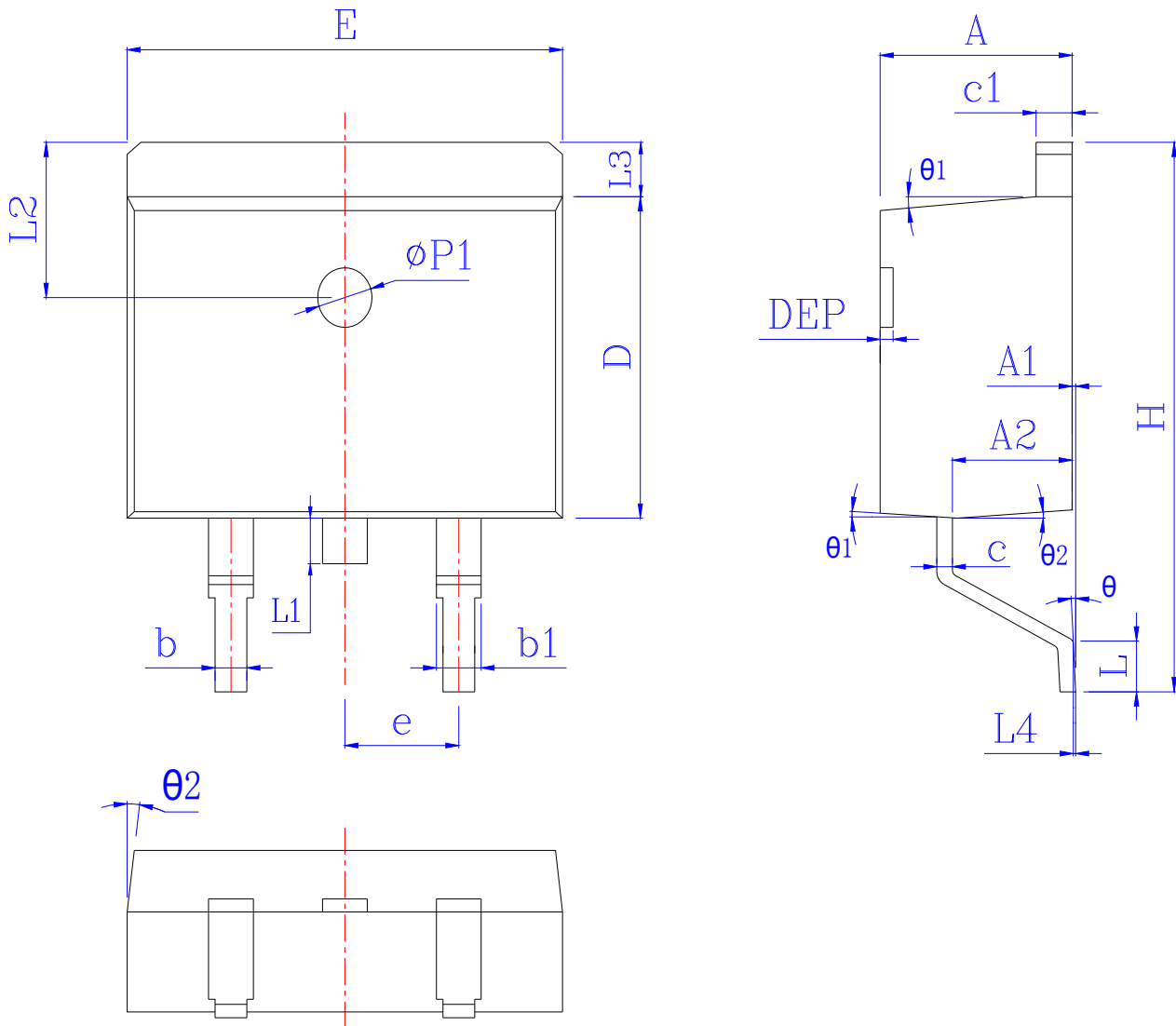

SYMBOL	MM			INCH			SYMBOL	MM			INCH		
	MIN	NOM	MAX	MIN	NOM	MAX		MIN	NOM	MAX	MIN	NOM	MAX
A	4.40	4.55	4.72	0.173	0.179	0.186	L	1.94	2.30	2.60	0.076	0.091	0.102
A1	0.00	0.10	0.25	0.000	0.005	0.010	L3	1.17	1.29	1.40	0.046	0.051	0.055
A2	2.59	2.69	2.79	0.102	0.106	0.110	L1	*	*	1.70	*	*	0.067
b	0.76	*	0.90	0.030	*	0.035	L4	0.25 BSC			0.01 BSC		
b1	1.22	*	1.36	0.048	*	0.054	L2	2.50 REF			0.098 REF		
c	0.33	*	0.47	0.013	*	0.019	$\theta$	0°	*	8°	0°	*	8°
c1	1.22	*	1.32	0.048	*	0.052	$\theta_1$	5°	7°	9°	5°	7°	9°
D	8.60	*	9.29	0.339	*	0.366	$\theta_2$	1°	3°	5°	1°	3°	5°
E	9.95	*	10.26	0.392	*	0.404	DEP	0.05	0.10	0.20	0.002	0.004	0.008
e	2.54BSC			0.100BSC			$\Phi p1$	1.40	1.50	1.60	0.055	0.059	0.063
H	14.70	15.10	15.79	0.579	0.594	0.622							

**Customer Service**

**Worldwide Sales and Service:**  
Sales@ruichips.com

**Technical Support:**  
Technical@ruichips.com

**Investor Relations Contacts:**  
Investor@ruichips.com

**Marcom Contact:**  
Marcom@ruichips.com

**Editorial Contact:**  
Editorial@ruichips.com

**HR Contact:**  
HR@ruichips.com

**Legal Contact:**  
Legal@ruichips.com

**Shen Zhen RUICHIPS Semiconductor CO., LTD**  
Room 501, the 5floor An Tong Industrial Building,  
NO.207 Mei Hua Road Fu Tian Area Shen Zhen City, CHINA

**TEL:** (86-755) 8311-5334  
**FAX:** (86-755) 8311-4278  
**E-mail:** Sales-SZ@ruichips.com