



TR18RDM SERIES 18 WATT AC-DC MEDICAL INTERCHANGEABLE PLUG ADAPTER

Features

- Universal Input Range 80~264Vac
- High Efficiency up to 87%
- Interchangeable AC Plugs
- Leakage Current < 30uA
- Class II
- No Load Power Consumption < 75mW
- Approval IEC/EN/UL 60601-1 2 MOPP
- Approval EN60601-1-11
for Home Healthcare Applications
- Approval EN55011, FCC 47 CFR Part 18 Class B
- Approval IP22
- Meets IEC/EN 60335-1
- Operating Altitude 5000m
- Over Voltage Protection
- Continuous Short Circuit Protection
- Meets CoC Tier 2 & DoE Level VI
(Output Cable Length \leq 1800mm)



AC Plug Sold Separately



| MODEL NUMBER | OUTPUT VOLTAGE | OUTPUT CURRENT | VOLTAGE ACCURACY NOTE1 | RIPPLE& NOISE NOTE2 | LINE REGULATION NOTE3 | LOAD REGULATION NOTE4 | %EFF. (Typ.) NOTE5 |
|--------------|----------------|----------------|------------------------|---------------------|-----------------------|-----------------------|--------------------|
| TR18RDM050 | 5V | 3A | ±5% | 100mV | ±1% | ±5% | 82% |
| TR18RDM090 | 9V | 2A | ±3% | 100mV | ±1% | ±3% | 86% |
| TR18RDM120 | 12V | 1.5A | ±3% | 120mV | ±1% | ±2% | 86% |
| TR18RDM150 | 15V | 1.2A | ±3% | 120mV | ±1% | ±2% | 86% |
| TR18RDM180 | 18V | 1A | ±3% | 120mV | ±1% | ±2% | 86% |
| TR18RDM240 | 24V | 0.75A | ±3% | 120mV | ±1% | ±2% | 87% |

Note:

1. Voltage accuracy is set at 60% full load.
2. Add a 0.1uF ceramic capacitor and a 10uF E.L. capacitor to output for ripple & noise measuring @20MHz BW.
3. Line regulation is measured from 100V_{ac} to 240V_{ac} with 100% full load.
4. Load regulation is measured from 60% to 100% full load and from 60% to 20% full load (60%±40% full load)
5. Typical efficiency at 230 V_{ac} and 75% full load at 25°C.

PART NUMBER

| Series | Output Voltage | AC Plug Type | DC Plug Type | Cable Type | Cable Length | Case Color |
|---------------------|--|--|--------------|---------------------|---|---|
| TR18RDM | XXX | -XXXX | -XX | X | XX | -XX-BK |
| 18W Medical Adapter | 050 :5V 090 :9V 120 :12V 150 :15V 180 :18V 240 :24V | Blank: Sold Separately ASUE: Include 4 Type AC Plug | See Page 6 | G : UL1571 with OVP | 01 : 720mm 02 : 1220mm 03 : 1800mm 11 : 720mm with Ferrite Core 12 : 1220mm with Ferrite Core 13 : 1800mm with Ferrite Core See page 6 for restrictions | BK-BK: Black-Black BE-BK: Blue-Black |

Part Number Example:

TR18RDM120-11G13-BK-BK, 12V_{dc} Output, DC Jack Type, Cable Length 1800mm with Ferrite Core, Case Color Black-Black

TR18RDM120-ASUE-11G03-BE-BK, 12V_{dc} Output, include 4 Type AC Plug, DC Jack Type, Cable Length 1800mm, Case Color Blue-Black



TR18RDM Series

TECHNICAL SPECIFICATIONS

(All specifications are typical at nominal input, full load at 25°C unless otherwise noted.)

ABSOLUTE MAXIMUM RATINGS

| PARAMETER | NOTES and CONDITIONS | Device | Min. | Typ. | Max. | Units |
|----------------------------|----------------------|--------|------|------|------|-----------------|
| Input Voltage | | All | 80 | | 264 | V _{ac} |
| Operating Case Temperature | See Derating Curve | All | -30 | | 70 | °C |
| Storage Temperature | | All | -30 | | 85 | °C |
| Operating Altitude | | All | | | 5000 | m |

INPUT CHARACTERISTICS

| PARAMETER | NOTES and CONDITIONS | Device | Min. | Typ. | Max. | Units |
|-------------------------|--|--------|------|------|------|-----------------|
| Operating Voltage Range | | All | 100 | | 240 | V _{ac} |
| Input Frequency Range | | All | 47 | | 63 | Hz |
| Maximum Input Current | 100% Full load, V _{in} =100V _{ac} | All | | | 0.5 | A |
| Leakage Current | | All | | | 30 | uA |
| Inrush Current | V _{in} =240V _{ac} , Cold start at 25°C | All | | 45 | | A |

OUTPUT CHARACTERISTICS

| PARAMETER | NOTES and CONDITIONS | Device | Min. | Typ. | Max. | Units |
|--------------------------------|--|------------|-------|------|-------|-----------------|
| Output Voltage Set Point | V _{in} =115V _{ac} and 230V _{ac} , I _o =60% Full load T _c =25°C | TR18RDM050 | 4.75 | 5 | 5.25 | V _{dc} |
| | | TR18RDM090 | 8.73 | 9 | 9.27 | |
| | | TR18RDM120 | 11.64 | 12 | 12.36 | |
| | | TR18RDM150 | 14.55 | 15 | 15.45 | |
| | | TR18RDM180 | 17.46 | 18 | 18.54 | |
| | | TR18RDM240 | 23.28 | 24 | 24.72 | |
| Operating Output Current Range | V _{in} =115V _{ac} and 230V _{ac} , T _c =25°C | TR18RDM050 | | | 3 | A |
| | | TR18RDM090 | | | 2 | |
| | | TR18RDM120 | | | 1.5 | |
| | | TR18RDM150 | | | 1.2 | |
| | | TR18RDM180 | | | 1 | |
| | | TR18RDM240 | | | 0.75 | |
| Holdup Time | V _{in} =115V _{ac} | All | | 12 | | ms |
| Output Voltage Regulation | | | | | | |
| Load Regulation | ±40% Full load change | TR18RDM050 | | | ±5.0 | % |
| | | TR18RDM090 | | | ±3.0 | |
| | | TR18RDM120 | | | ±2.0 | |
| | | TR18RDM150 | | | ±2.0 | |
| | | TR18RDM180 | | | ±2.0 | |
| | | TR18RDM240 | | | ±2.0 | |
| Line Regulation | V _{in} =100V _{ac} to 240V _{ac} | All | | | ±1.0 | % |
| Over Voltage Protection | TVS Component to clamp | TR18RDM050 | | | 7.14 | V _{dc} |
| | | TR18RDM090 | | | 12.60 | |
| | | TR18RDM120 | | | 15.75 | |
| | | TR18RDM150 | | | 18.90 | |
| | | TR18RDM180 | | | 23.1 | |
| | | TR18RDM240 | | | 31.5 | |
| Over Current Protection | Auto recovery | All | 110 | | 180 | % |
| Short Circuit Protection | Auto recovery | All | | | | |



TR18RDM Series

| PARAMETER | NOTES and CONDITIONS | Device | Min. | Typ. | Max. | Units |
|-------------------------|---|------------|------|------|------|-------|
| Output Ripple and Noise | 1. Add a 0.1uF ceramic capacitor and a 10uF aluminum electrolytic capacitor to output 2. Oscilloscope is 20MHz band width 3. Ambient temperature=25°C | TR18RDM050 | | | 100 | mV |
| | | TR18RDM090 | | | 100 | |
| | | TR18RDM120 | | | 120 | |
| | | TR18RDM150 | | | 120 | |
| | | TR18RDM180 | | | 120 | |
| | | TR18RDM240 | | | 120 | |
| Load Capacitance | 1. $V_{in}=115V_{ac}$ and $230V_{ac}$ 2. Output is max. load 3. Ambient temperature=25°C | TR18RDM050 | | | 3000 | uF |
| | | TR18RDM090 | | | 2000 | |
| | | TR18RDM120 | | | 1500 | |
| | | TR18RDM150 | | | 1200 | |
| | | TR18RDM180 | | | 1000 | |
| | | TR18RDM240 | | | 750 | |
| Efficiency | 1. $V_{in}=230V_{ac}$ 2. Output is 75% full load 3. Ambient temperature=25°C | TR18RDM050 | | 82 | | % |
| | | TR18RDM090 | | 86 | | |
| | | TR18RDM120 | | 86 | | |
| | | TR18RDM150 | | 86 | | |
| | | TR18RDM180 | | 86 | | |
| | | TR18RDM240 | | 87 | | |

ISOLATION CHARACTERISTICS

| PARAMETER | NOTES and CONDITIONS | Device | Min. | Typ. | Max. | Units |
|----------------------|----------------------|--------|------|------|------|----------|
| Input to Output | 1 minute | All | | | 4000 | V_{ac} |
| Isolation Resistance | Input to output | All | 100 | | | MΩ |

FEATURE CHARACTERISTICS

| PARAMETER | NOTES and CONDITIONS | Device | Min. | Typ. | Max. | Units |
|---------------------|-----------------------|--------|------|------|------|-------|
| Switching Frequency | Pout=max. rated power | All | | 50 | | kHz |

GENERAL SPECIFICATIONS

| PARAMETER | NOTES and CONDITIONS | Device | Min. | Typ. | Max. | Units |
|--|---|--------|---|------|------|------------|
| MTBF | $I_o=100\%$; $T_a=25^\circ C$ per MIL-HDBK-217F | All | 750 | | | k hours |
| Humidity | Non-condensing | All | | | 93 | % RH |
| Shock | Meet MIL-STD-810F Table 516.5, Table 516.5-I 10ms, each axis 3 times($\pm X$ 、 $\pm Y$ 、 $\pm Z$ axis) | All | | 75 | | g |
| Vibration | Meet MIL-STD-810F Table 514.5C-VIII, 15~2000Hz, X、Y、Z axis, 1 hour (each axis),. Total 3 hrs. | All | | 4 | | g |
| Weight | | All | | 115 | | g |
| Dimensions | | All | 3.165x1.693x1.453 Inches (80.40x43.00x36.90mm) | | | |
| Safety | Class II, IEC 60601-1:2005, COR1:2006, COR2:2007, AMD1:2012, EN 60601-1:2006+A11+A1+A12 ANSI/AAMI ES60601-1 (2005/(R)2012+A1:2012, C1:2009/(R)2012+A2:2010/(R)2012) IEC/EN 60601-1-11:2015 for Home Healthcare Applications | | | | | Ed.3.1 |
| EMC Emission | EN 55011:2016+A1:2017, CISPR 11:2015+A1:2016, Class B, EN 61003-3:2013, FCC 47 CFR Part 18 | | | | | |
| Conducted Disturbance | EN 55011:2016+A1:2017, CISPR 11:2015+A1:2016, FCC 47 CFR Part 18 | | | | | Class B |
| Radiated Disturbance | EN 55011:2016+A1:2017, CISPR 11:2015+A1:2016, FCC 47 CFR Part 18 | | | | | Class B |
| Voltage Fluctuations | EN 61000-3-3:2013 | | | | | |
| EMC Immunity | EN60601-1-2:2015, IEC61000-4-2,3,4,5,6,8,11 | | | | | Ed.4.0 |
| Electrostatic Discharge (ESD) | IEC 61000-4-2:2008, Air Discharge: $\pm 15kV$ Contact Discharge: $\pm 8kV$ | | | | | Criteria A |
| Radio-Frequency, Continuous Radiated Disturbance | IEC 61000-4-3:2006+A1:2007+A2:2010 | | | | | Criteria A |
| Electrical Fast Transient (EFT) | IEC 61000-4-4:2012, $\pm 0.5kV$, $\pm 1kV$, $\pm 2kV$ | | | | | Criteria A |



TR18RDM Series

GENERAL SPECIFICATIONS

| | | |
|--|--|------------|
| Surge | IEC 61000-4-5:2014/AMD1:2017, L-N: $\pm 0.5kV$, $\pm 1kV$ | Criteria A |
| Conducted disturbances, induced by RF fields | IEC 61000-4-6:2013 | Criteria A |
| Power frequency magnetic field | IEC 61000-4-8:2009 | Criteria A |
| Voltage dips | IEC 61000-4-11:2004/AMD1:2017, Dips: 30% Reduction, Dips: >95% Reduction | Criteria A |
| Voltage interruptions | IEC 61000-4-11:2004/AMD1:2017, >95% reduction | Criteria A |
| Application Note Link | TR18RDM Series App Notes | |

CHARACTERISTIC CURVE

Power Derating Curve

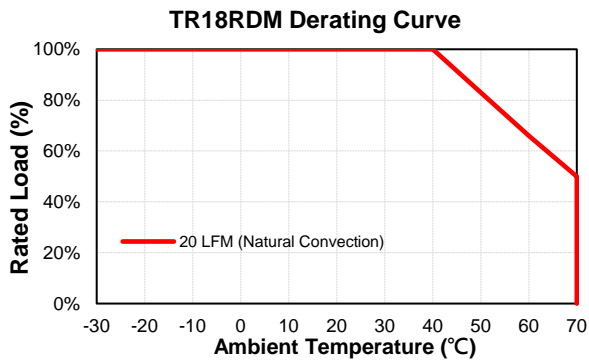

Performance Data

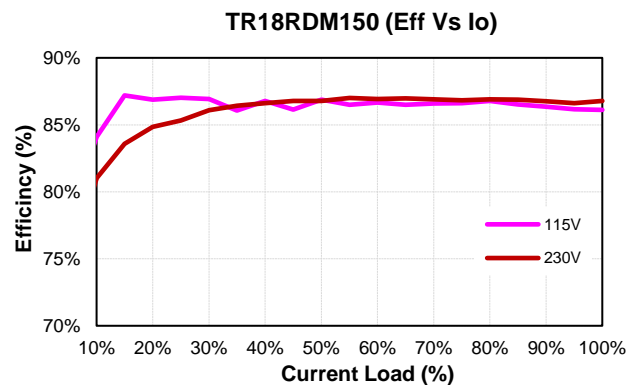
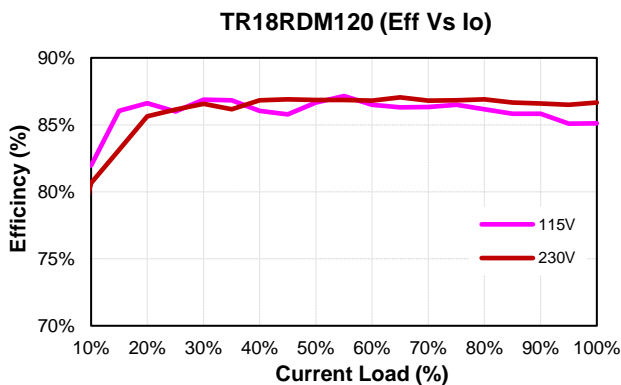
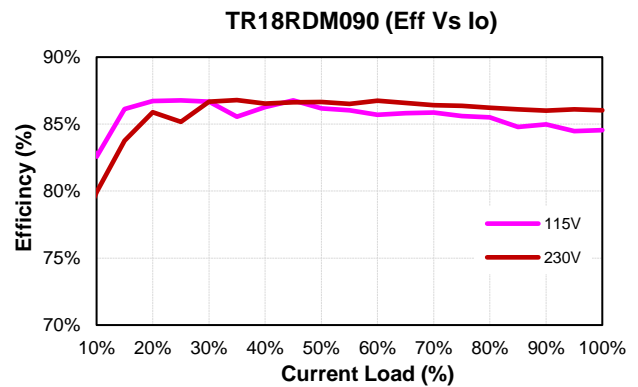
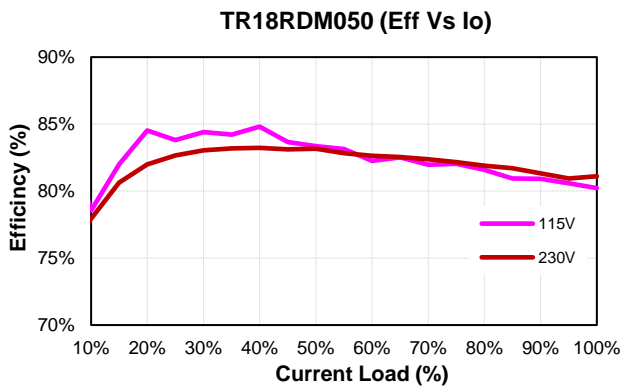



TR18RDM Series

TR18RDM180 (Eff Vs Io)

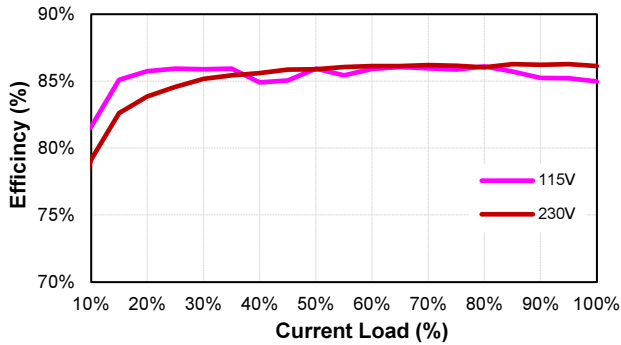

TR18RDM240 (Eff Vs Io)

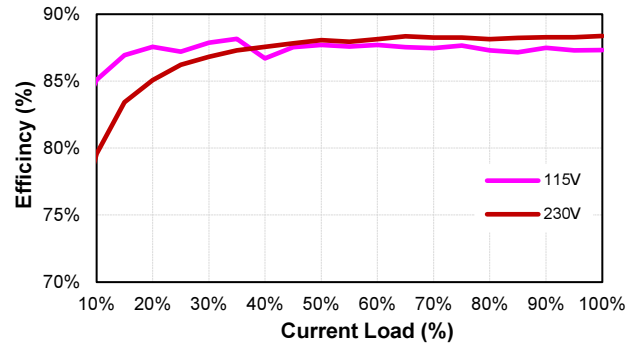



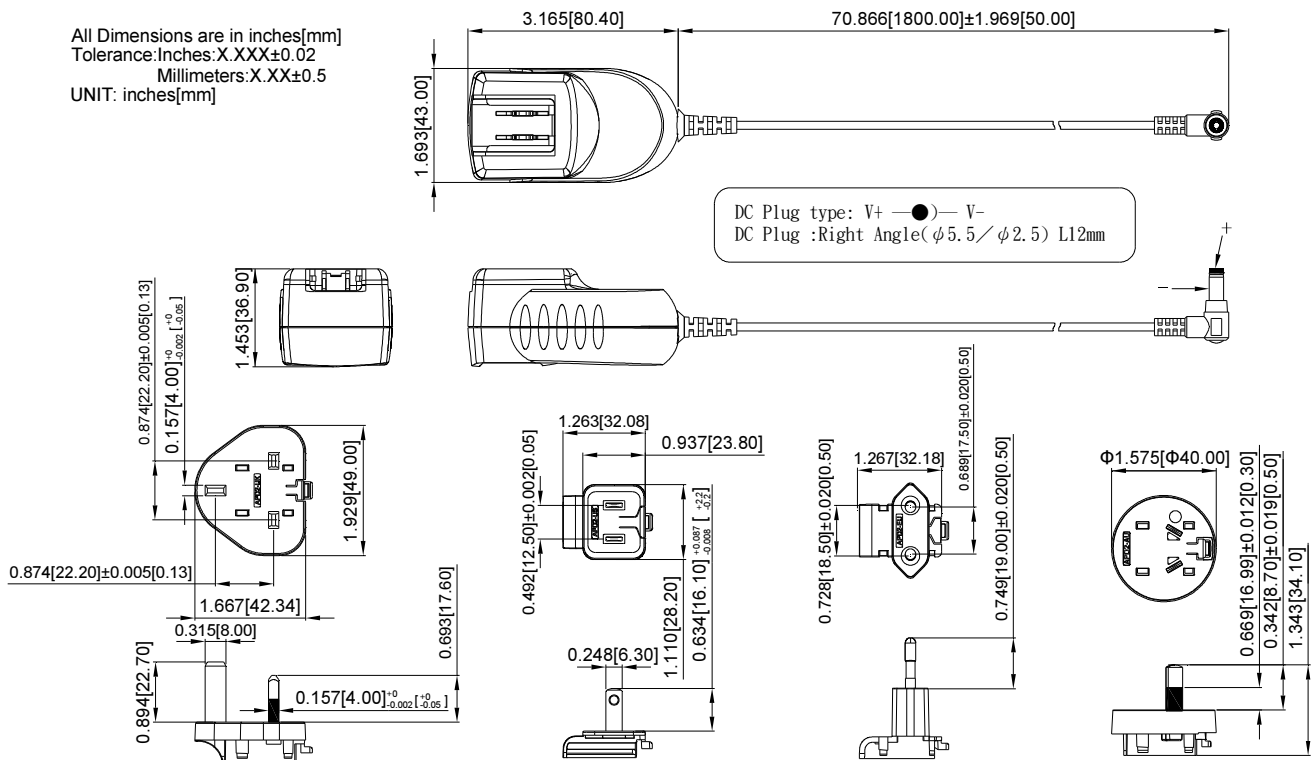

MECHANICAL SPECIFICATION

All Dimensions are in inches[mm]
Tolerance: Inches: X.XXX±0.02
Millimeters: X.XX±0.5
UNIT: inches[mm]

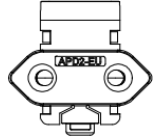

INTERCHANGEABLE AC PLUG SPECIFICALLY for TR18RDM (SOLD SEPARATELY)

| TYPE |  |  |  |  |
|-----------|---|---|--|---|
| | U.K type (U) | American type (A) | European type (E) | Australian type (S) |
| ORDER NO. | AC PLUG RE-U | AC PLUG RE-A | AC PLUG RE-E | AC PLUG RE-S |



TR18RDM Series

STANDARD OUTPUT DC PLUG

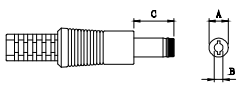
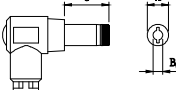
| DC Plug Type | Cable Number-XXXXX | A | B | C | Cable Type | Cable Length | Cable AWG |
|---|--------------------|---------|---------|--------|------------|------------------------|---|
| | | OD (mm) | ID (mm) | L (mm) | | | |
|  <p>Straight/Inner+Outer- + ● -</p> | 11G03 | Φ5.5 | Φ2.1 | 12 | UL1571 | 1800mm without Core | 18AWG for Vo: 5V, 9V 22AWG for Vo: 12V, 15V, 18V, 24V |
| | 12G03 | Φ5.5 | Φ2.5 | 12 | | | |
| | 23G03 | Φ5.5 | Φ2.1 | 9.5 | | | |
| | 26G03 | Φ5.5 | Φ2.5 | 9.5 | | | |
|  <p>Right Angle/Inner+Outer- + ● -</p> | 01G03 | Φ5.5 | Φ2.1 | 12 | | | |
| | 02G03 | Φ5.5 | Φ2.5 | 12 | | | |
| | 21G03 | Φ5.5 | Φ2.5 | 9.5 | | | |
| | 24G03 | Φ5.5 | Φ2.1 | 9.5 | | | |

※Other DC Plug Type please refer to the link: <https://www.cincon.com/productdownload/TR18RDM-cable-DC-plug.pdf>

CINCON Electronics Co. Ltd.
 Add: 14F, No. 306, Sec.4, Hsin Yi Rd., Taipei, Taiwan
 Tel: 886-2-27086210
 Fax: 886-2-27029852
 E-mail: sales@cincon.com.tw
 Web: www.cincon.com

Mouser Electronics

Authorized Distributor

Click to View Pricing, Inventory, Delivery & Lifecycle Information:

Cincon:

[TR18RDM120-12G03 BK-BK VI](#) [TR18RDM050-01G03 BK-BK VI](#) [TR18RDM240-01G03 BK-BK VI](#) [TR18RDM090-01G03 BK-BK VI](#) [TR18RDM050-12G03 BK-BK VI](#) [TR18RDM150-12G03 BK-BK VI](#) [TR18RDM180-12G03 BK-BK VI](#) [TR18RDM120-01G03 BK-BK VI](#) [TR18RDM240-12G03 BK-BK VI](#) [TR18RDM090-12G03 BK-BK VI](#) [TR18RDM180-01G03 BK-BK VI](#) [TR18RDM150-01G03 BK-BK VI](#)