



CFM12S SERIES 12 WATT OPEN FRAME AC-DC MODULES

Features

- Universal Input Range 90~264Vac
- High Efficiency up to 87%
- 1.5" x 1" Open Frame Compact Size
- Class II
- No Load Input Power < 75mW
- Approval IEC/EN/UL 62368-1
- Approval IEC/EN 60335-1
- Approval EN 55032 Class B and CISPR/FCC Class B
- Operating Altitude 5000m
- Continuous Short Circuit Protection
- Over Voltage Protection



MODEL NUMBER	OUTPUT VOLTAGE	OUTPUT CURRENT	VOLTAGE ACCURACY NOTE1	RIPPLE & NOISE NOTE2	LINE REGULATION NOTE3	LOAD REGULATION NOTE4	%EFF. (Typ.) NOTE5
CFM12S050	5 V	2 A	±2%	100mV	±1%	±1%	80%
CFM12S090	9 V	1.34 A	±2%	100mV	±1%	±1%	85%
CFM12S120	12 V	1.0 A	±2%	120mV	±1%	±1%	85%
CFM12S150	15 V	0.8 A	±2%	150mV	±1%	±1%	85%
CFM12S240	24 V	0.5 A	±2%	240mV	±1%	±1%	87%

Note:

1. Voltage accuracy is set at 100% full load.
2. Add a 0.1uF ceramic capacitor and a 10uF E.L. capacitor to output for ripple & noise measurement @20MHz BW.
3. Line regulation is measured from 90V_{ac} to 264V_{ac} with 100% full load.
4. Load regulation is measured from 10% to 100% full load.
5. Typical efficiency at 230 V_{ac} and 100% full load at 25°C.
6. T Version wafer with JST B3B-XH/B4B-XH and mate with JST housing XH series or equivalent.
7. L Version & EL Version Safety only approved only IEC/EN 60335-1.

PART NUMBER

Series	Number of Outputs	Nominal Output Voltage	Type
CFM12	X	XXX	-XX
CFM12	S: Single	050: 5V 090: 9V 120: 12V 150: 15V 240: 24V	Blank: PCB Mount E: Encapsulated T: Wafer L: Lead Wire EL: Encapsulated & Lead Wire

Part Number Example:

CFM12S120-T: Open Frame, 12W, Single 12Vdc Output, Wafer



CFM12S Series

TECHNICAL SPECIFICATIONS

(All specifications are typical at nominal input, full load at 25°C unless otherwise noted.)

ABSOLUTE MAXIMUM RATINGS

PARAMETER	NOTES and CONDITIONS	Device	Min.	Typ.	Max.	Units
Input Voltage	Safety approvals only to the AC input	All	90		264	V _{ac}
			120		370	V _{dc}
Operating Case Temperature	See Derating Curve	All	-40		75	°C
Storage Temperature		All	-40		85	°C
Operating Altitude	IEC/EN/UL 62368-1	All			5000	m
	IEC/EN 60335-1					

INPUT CHARACTERISTICS

PARAMETER	NOTES and CONDITIONS	Device	Min.	Typ.	Max.	Units
Operating Voltage Range		All	100		240	V _{ac}
Input Frequency Range		All	50		60	Hz
Maximum Input Current	100% Load, V _{in} =100V _{ac}	All			0.4	A
Leakage Current		All			0.25	mA
Inrush Current	V _{in} =240V _{ac} , Cold start at 25°C	All			50	A

OUTPUT CHARACTERISTICS

PARAMETER	NOTES and CONDITIONS	Device	Min.	Typ.	Max.	Units
Output Voltage Set Point	V _{in} =Nominal V _{in} , I _o =I _o max., T _c =25°C	CFM12S050	4.90	5	5.10	V _{dc}
		CFM12S090	8.82	9	9.18	
		CFM12S120	11.76	12	12.24	
		CFM12S150	14.70	15	15.30	
		CFM12S240	23.52	24	24.48	
Operating Output Current Range	V _{in} =90V _{ac} ~264V _{ac} , See Derating Curve	CFM12S050			2.0	A
		CFM12S090			1.34	
		CFM12S120			1.0	
		CFM12S150			0.8	
		CFM12S240			0.5	
Holdup Time	V _{in} =115V _{ac}	All		10		ms
Output Voltage Regulation						
Load Regulation	10% Load to full load	All			±1.0	%
Line Regulation	V _{in} =High Line to low line	All			±1.0	%
Over Voltage Protection	Hiccup mode (Auto recovery)	CFM12S050			6.3	V _{dc}
		CFM12S090			12.6	
		CFM12S120			15.8	
		CFM12S150			18.9	
		CFM12S240			31.5	
Output Ripple and Noise	1. Add a 0.1uF ceramic capacitor and a 10uF aluminum electrolytic capacitor to output 2. Oscilloscope is 20MHz band width 3. Ambient Temperature=25°C	CFM12S050			100	mV
		CFM12S090			100	
		CFM12S120			120	
		CFM12S150			150	
		CFM12S240			240	
Load Capacitance	1. V _{in} =115V _{ac} and 230V _{ac} 2. Output is max. load 3. Ambient temperature=25°C	CFM12S050			2000	uF
		CFM12S090			1340	
		CFM12S120			1000	
		CFM12S150			800	
		CFM12S240			500	



CFM12S Series

PARAMETER	NOTES and CONDITIONS	Device	Min.	Typ.	Max.	Units
Efficiency	1. Output is rated load 2. Ambient temperature=25°C 3. Input voltage is 230V _{ac}	CFM12S050		80		%
		CFM12S090		85		
		CFM12S120		85		
		CFM12S150		85		
		CFM12S240		87		

ISOLATION CHARACTERISTICS

PARAMETER	NOTES and CONDITIONS	Device	Min.	Typ.	Max.	Units
Input to Output	1 minute	All			3000	V _{ac}
Isolation Resistance	Input to output	All	100			MΩ

FEATURE CHARACTERISTICS

PARAMETER	NOTES and CONDITIONS	Device	Min.	Typ.	Max.	Units
Switching Frequency	P _{out} =max. rated power	All		65		kHz

GENERAL SPECIFICATIONS

PARAMETER	NOTES and CONDITIONS	Device	Min.	Typ.	Max.	Units
MTBF	I _o =100%; T _a =25°C per MIL-HDBK-217F	All	580			k hours
Humidity	Non-condensing	All			93	% RH
Shock	Meet MIL-STD-810F Table 516.5, Table 516.5-I 10ms, each axis 3 times(±X、±Y、±Z axis)	All		75		g
Vibration	Meet MIL-STD-810F Table 514.5C-VIII, 15~2000Hz, X、Y、Z axis, 1 hour (each axis), Total 3 hrs.	All		4		g
Weight		CFM12S		16		grams
		CFM12S-E		40		
		CFM12S-T		17		
		CFM12S-L		21		
		CFM12S-EL		45		
Dimensions	Blank (PCB mount)	All	1.500x1.000x0.756 Inches (38.10x25.40x19.20 mm)			
	E (Encapsulated)	All	1.600x1.100x0.772 Inches (40.64x27.94x19.60mm)			
	T (Wafer)	All	2.150x1.000x0.689 Inches (54.61x25.40x17.50mm)			
	L (Lead wire)	All	1.500x1.000x0.681 Inches (38.10x25.40x17.30mm)			
	EL (Encapsulated & Lead wire)	All	1.600x1.100x0.772 Inches (40.64x27.94x19.60mm)			
Safety	Class II, IEC/EN/UL 62368-1, IEC/UL 60950-1, IEC/EN 60335-1 L Version & EL Version Safety only approved only IEC/EN 60335-1					
EMC Emission	EN 55032, EN 61000-3-2, EN 6100-3-3, EN 61000-6-3, Class B. EN 61000-6-4 47 CFR FCC Part 15 Subpart B (Class B)					Class B
Conducted Disturbance	EN 55032 2015, EN 6100-6-3 2007+A1: 2011+AC: 2012, Class B. EN 61000-6-4 47 CFR FCC Part 15 Subpart B (Class B)					Class B
Radiated Disturbance	EN 55032 2015, EN 6100-6-3 2007+A1: 2011+AC: 2012, Class B. EN 61000-6-4 47 CFR FCC Part 15 Subpart B (Class B)					Class B
Harmonic Current Emissions	EN 61000-3-2:2014					
Voltage Fluctuations & Flicker	EN 61000-3-3:2013					
EMC Immunity	EN 55024 2010+A1:2015, EN 61204-3:2000, EN 61000-6-1:2007, EN 61000-6-2:2005					
Electrostatic Discharge (ESD)	IEC 61000-4-2:2008, Air Discharge: ±8kV, Contact Discharge: ±4kV					Criterion B
Radio-Frequency, Continuous Radiated Disturbance	IEC 61000-4-3:2010					Criterion A
Electrical Fast Transient (EFT)	IEC61000-4-4:2012, ±1kV, ±2kV					Criterion B
Surge	IEC61000-4-5:2014, L-N: ±1kV					Criterion B
Conducted Disturbances, Induced by RF Fields	IEC 61000-4-6:2013					Criterion A



CFM12S Series

GENERAL SPECIFICATIONS

Power Frequency Magnetic Field	IEC 61000-4-8:2009	Criterion A
Voltage Dips	IEC 61000-4-11:2004, Dip: 30% Reduction, Dip >95% Reduction	Criterion C
Voltage Interruptions	IEC 61000-4-11:2004, >95% Reduction	Criterion C
Application Note Link	CFM12S Series App Notes	

CHARACTERISTIC CURVE

Power Derating Curve

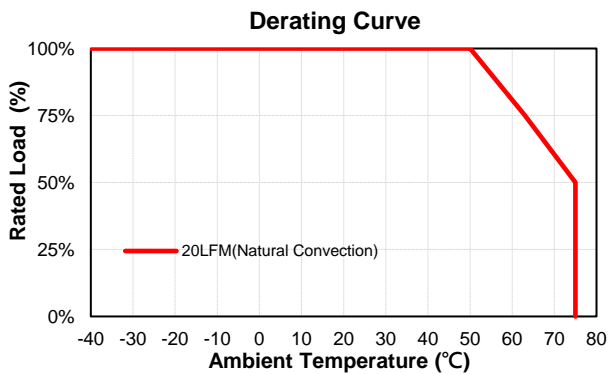

Performance Data

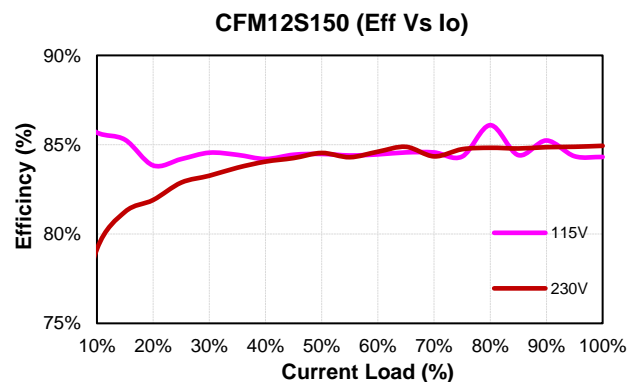
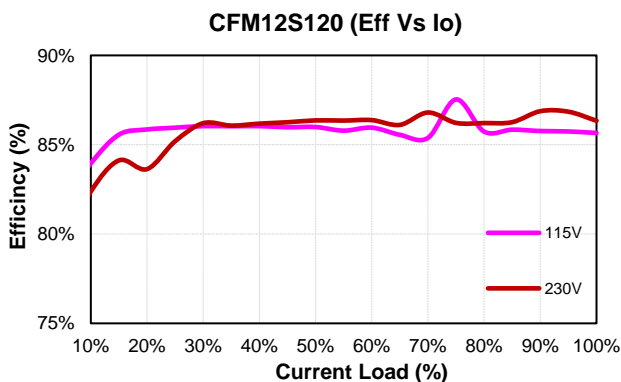
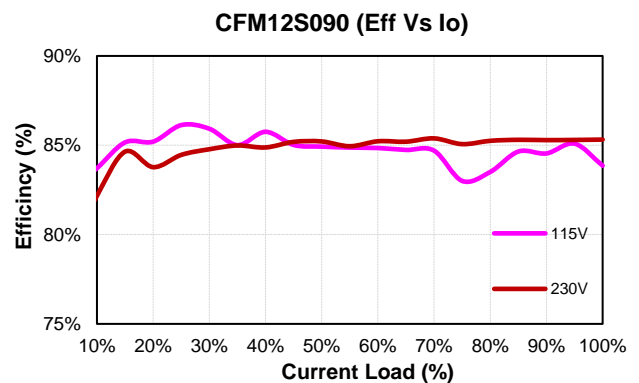
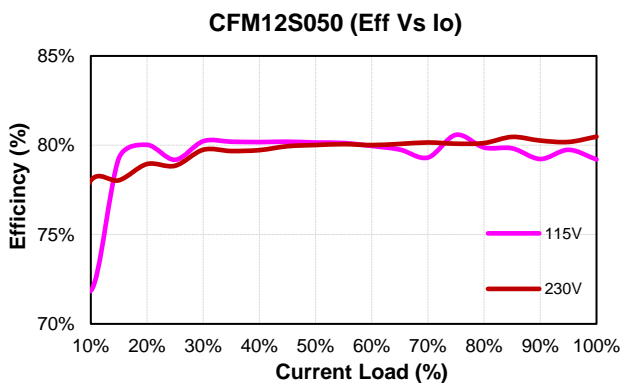



CFM12S Series

CFM12S240 (Eff Vs Io)

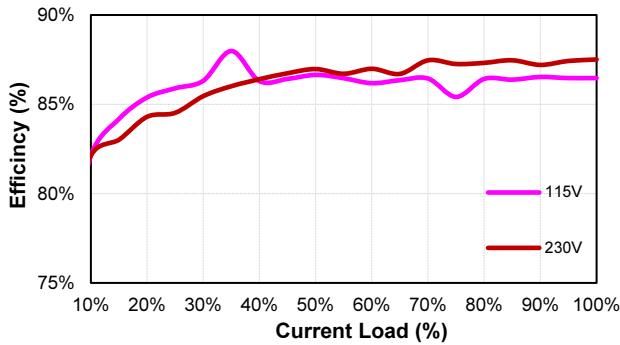

MECHANICAL SPECIFICATION

CFM12SXXX

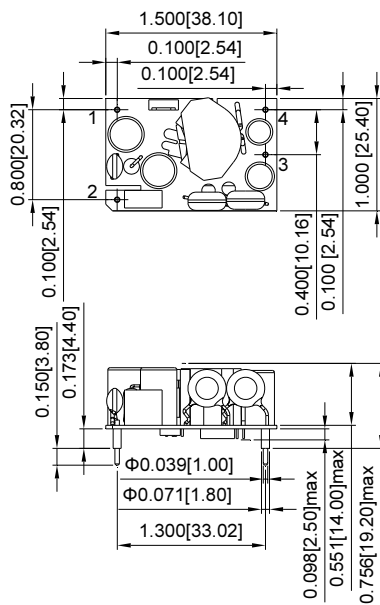

CFM12SXXX-E

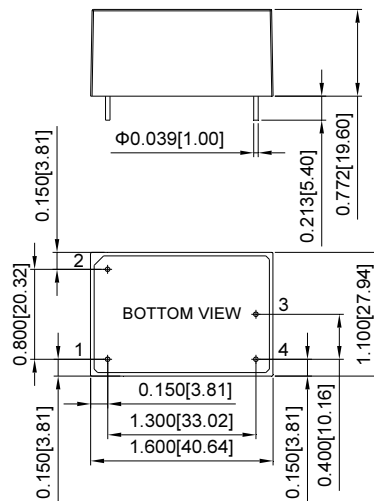

PIN CONNECTION

Pin	Function
1	ACN
2	ACL
3	-Vout
4	+Vout

All Dimensions are in inches[mm]
Tolerance: Inches: X.XXX±0.02
Millimeters: X.XX±0.5

CFM12SXXX-T

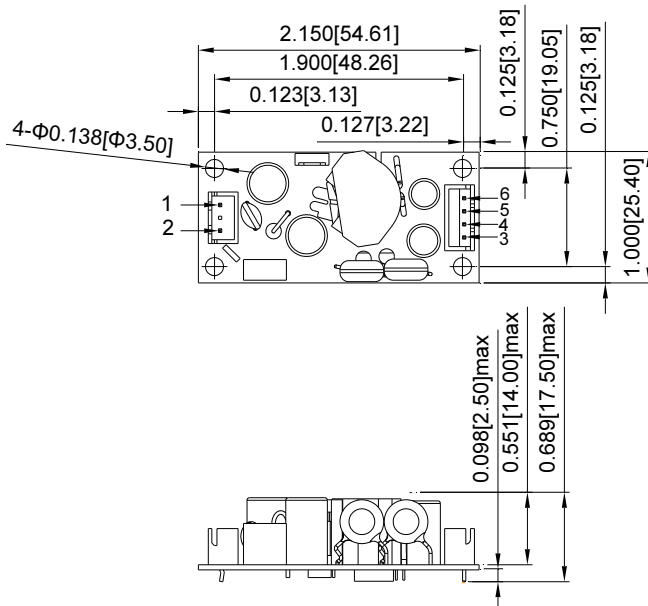

PIN CONNECTION

Pin	Function
1	ACN
2	ACL
3	-Vout
4	-Vout
5	+Vout
6	+Vout

All Dimensions are in inches[mm]
Tolerance: Inches: X.XXX±0.02
Millimeters: X.XX±0.5



CFM12S Series

CFM12SXXX-L

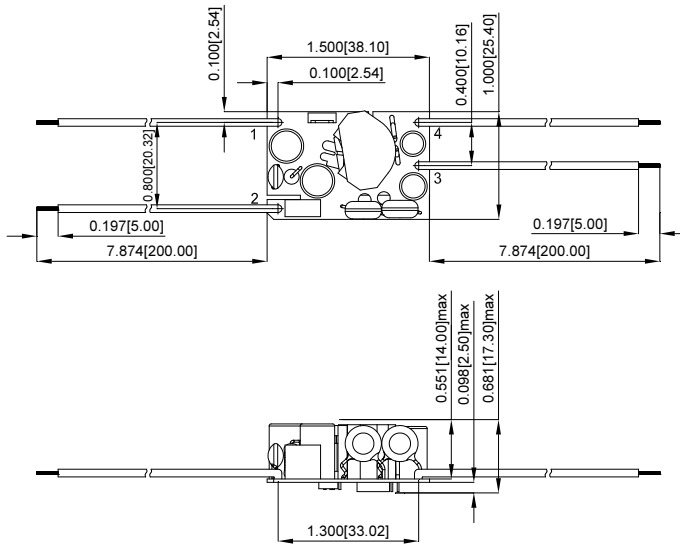

CONNECTION	
Pin	Function
1 (Blue)	ACN
2 (Brown)	ACL
3 (Black)	-Vout
4 (Red)	+Vout

Cable: 20AWG/UL 1007, $\Phi 1.8 \pm 0.2\text{mm}$
 All Dimensions In Inches[mm]
 Tolerance Inches:x.xxx = ± 0.02
 Millimeters: x.xx = ± 0.5

CFM12SXXX-EL

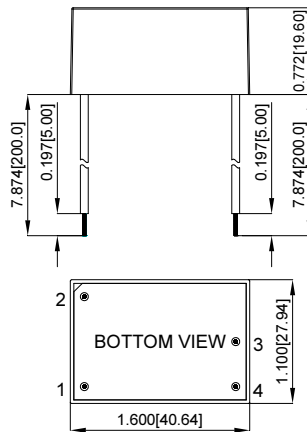

CONNECTION	
Pin	Function
1 (Blue)	ACN
2 (Brown)	ACL
3 (Black)	-Vout
4 (Red)	+Vout

Cable: 20AWG/UL 1007, $\Phi 1.8 \pm 0.2\text{mm}$
 All Dimensions In Inches[mm]
 Tolerance Inches:x.xxx = ± 0.02
 Millimeters: x.xx = ± 0.5

CINCON Electronics Co. Ltd.
 Add: 14F, No. 306, Sec.4, Hsin Yi Rd., Taipei, Taiwan
 Tel: 886-2-27086210
 Fax: 886-2-27029852
 E-mail: sales@cincon.com.tw
 Web: www.cincon.com

Mouser Electronics

Authorized Distributor

Click to View Pricing, Inventory, Delivery & Lifecycle Information:

Cincon:

[CFM12S050-E](#) [CFM12S240](#) [CFM12S090-E](#) [CFM12S050](#) [CFM12S150-T](#) [CFM12S150-E](#) [CFM12S120](#)
[CFM12S120-T](#) [CFM12S090](#) [CFM12S240-T](#) [CFM12S050-T](#) [CFM12S240-E](#) [CFM12S090-T](#) [CFM12S120-E](#)
[CFM12S150](#)