

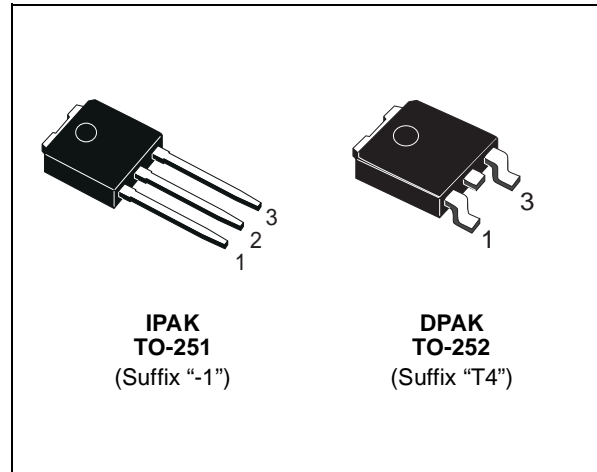


STD10PF06

P-CHANNEL 60V - 0.18 Ω - 10A IPAK/DPAK STripFET™ II POWER MOSFET

TYPE	V _{DSS}	R _{DS(on)}	I _D
STD10PF06	60 V	< 0.20 Ω	10 A

- TYPICAL R_{DS(on)} = 0.18 Ω
- EXCEPTIONAL dv/dt CAPABILITY
- 100% AVALANCHE TESTED
- LOW GATE CHARGE
- APPLICATION ORIENTED CHARACTERIZATION
- THROUGH-HOLE IPAK (TO-251) POWER PACKAGE IN TUBE (SUFFIX "-1")
- SURFACE-MOUNTING DPAK (TO-252) POWER PACKAGE IN TAPE & REEL (SUFFIX "T4")



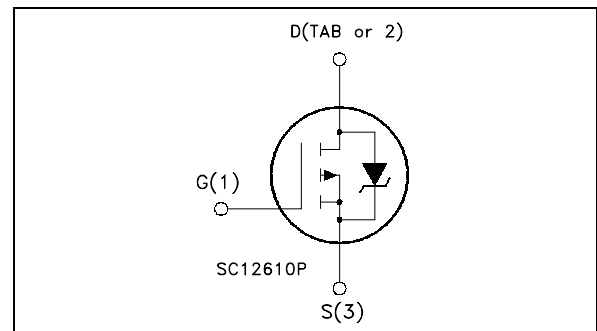
DESCRIPTION

This Power MOSFET is the latest development of STMicroelectronics unique "Single Feature Size™" strip-based process. The resulting transistor shows extremely high packing density for low on-resistance, rugged avalanche characteristics and less critical alignment steps therefore a remarkable manufacturing reproducibility.

APPLICATIONS

- MOTOR CONTROL
- DC-DC & DC-AC CONVERTERS

INTERNAL SCHEMATIC DIAGRAM



ABSOLUTE MAXIMUM RATINGS

Symbol	Parameter	Value	Unit
V _{DS}	Drain-source Voltage (V _{GS} = 0)	60	V
V _{DGR}	Drain-gate Voltage (R _{GS} = 20 kΩ)	60	V
V _{GS}	Gate- source Voltage	± 20	V
I _D	Drain Current (continuous) at T _C = 25°C	10	A
I _D	Drain Current (continuous) at T _C = 100°C	7	A
I _{DM} (*)	Drain Current (pulsed)	40	A
P _{tot}	Total Dissipation at T _C = 25°C	40	W
	Derating Factor	0.27	W/°C
dv/dt (1)	Peak Diode Recovery voltage slope	6	V/ns
T _{stg}	Storage Temperature	-65 to 175	°C
T _j	Max. Operating Junction Temperature	175	°C

(*) Pulse width limited by safe operating area.
Note: P-CHANNEL MOSFET actual polarity of voltages and current has to be reversed

(1) I_{SD} ≤ 10A, di/dt ≤ 300A/μs, V_{DD} ≤ V_{(BR)DSS}, T_j ≤ T_{JMAX}

STD10PF06

THERMAL DATA

Rthj-case	Thermal Resistance Junction-case	Max	3.75	°C/W
Rthj-amb	Thermal Resistance Junction-ambient	Max	100	°C/W
T _l	Maximum Lead Temperature For Soldering Purpose		275	°C

AVALANCHE CHARACTERISTICS

Symbol	Parameter	Max Value	Unit
I _{AR}	Avalanche Current, Repetitive or Not-Repetitive (pulse width limited by T _j max)	10	A
E _{AS}	Single Pulse Avalanche Energy (starting T _j = 25 °C, I _D = I _{AR} , V _{DD} = 25 V)	125	mJ

ELECTRICAL CHARACTERISTICS (T_{CASE} = 25 °C UNLESS OTHERWISE SPECIFIED)

OFF

Symbol	Parameter	Test Conditions	Min.	Typ.	Max.	Unit
V _{(BR)DSS}	Drain-source Breakdown Voltage	I _D = 250 μA, V _{GS} = 0	60			V
I _{DSS}	Zero Gate Voltage Drain Current (V _{GS} = 0)	V _{DS} = Max Rating V _{DS} = Max Rating T _C = 125°C			1 10	μA μA
I _{GSS}	Gate-body Leakage Current (V _{DS} = 0)	V _{GS} = ± 20V			±1	μA

ON (*)

Symbol	Parameter	Test Conditions	Min.	Typ.	Max.	Unit
V _{GS(th)}	Gate Threshold Voltage	V _{DS} = V _{GS} I _D = 250 μA	2		4	V
R _{DS(on)}	Static Drain-source On Resistance	V _{GS} = 10 V I _D = 5 A		0.18	0.20	Ω

DYNAMIC

Symbol	Parameter	Test Conditions	Min.	Typ.	Max.	Unit
g _{fs} (*)	Forward Transconductance	V _{DS} = 25 V I _D = 5 A	2	5		S
C _{iSS} C _{oSS} C _{rSS}	Input Capacitance Output Capacitance Reverse Transfer Capacitance	V _{DS} = 25 V f = 1 MHz V _{GS} = 0		850 230 75		pF pF pF

STD10PF06

ELECTRICAL CHARACTERISTICS (continued)

SWITCHING ON

Symbol	Parameter	Test Conditions	Min.	Typ.	Max.	Unit
$t_{d(on)}$ t_r	Turn-on Delay Time Rise Time	$V_{DD} = 30\text{ V}$ $I_D = 5\text{ A}$ $R_G = 4.7\ \Omega$ $V_{GS} = 10\text{ V}$ (Resistive Load, Figure 3)		20 40		ns ns
Q_g Q_{gs} Q_{gd}	Total Gate Charge Gate-Source Charge Gate-Drain Charge	$V_{DD} = 48\text{ V}$ $I_D = 10\text{ A}$ $V_{GS} = 10\text{ V}$		16 4 6	21	nC nC nC

SWITCHING OFF

Symbol	Parameter	Test Conditions	Min.	Typ.	Max.	Unit
$t_{d(off)}$ t_f	Turn-off Delay Time Fall Time	$V_{DD} = 30\text{ V}$ $I_D = 5\text{ A}$ $R_G = 4.7\ \Omega$, $V_{GS} = 10\text{ V}$ (Resistive Load, Figure 3)		40 10		ns ns
$t_r(V_{off})$ t_f t_c	Off-voltage Rise Time Fall Time Cross-over Time	$V_{clamp} = 48\text{ V}$ $I_D = 10\text{ A}$ $R_G = 4.7\ \Omega$, $V_{GS} = 10\text{ V}$ (Inductive Load, Figure 5)		10 17 30		ns ns ns

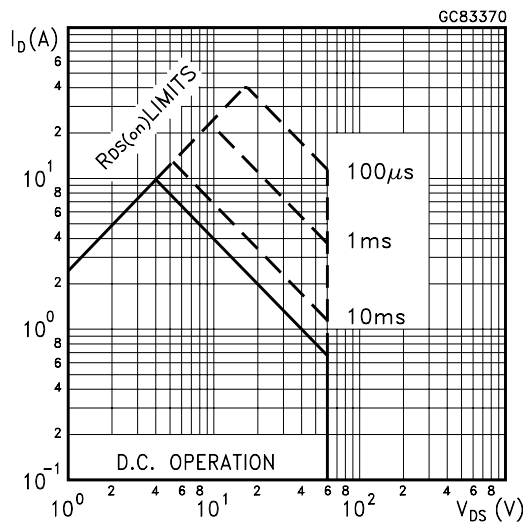
SOURCE DRAIN DIODE

Symbol	Parameter	Test Conditions	Min.	Typ.	Max.	Unit
I_{SD} $I_{SDM}(\bullet)$	Source-drain Current Source-drain Current (pulsed)				10 40	A A
$V_{SD}(\ast)$	Forward On Voltage	$I_{SD} = 10\text{ A}$ $V_{GS} = 0$			2.5	V
t_{rr} Q_{rr} I_{RRM}	Reverse Recovery Time Reverse Recovery Charge Reverse Recovery Current	$I_{SD} = 10\text{ A}$ $di/dt = 100\text{ A}/\mu\text{s}$ $V_{DD} = 30\text{ V}$ $T_j = 150^\circ\text{C}$ (see test circuit, Figure 5)		100 260 5.2		ns μC A

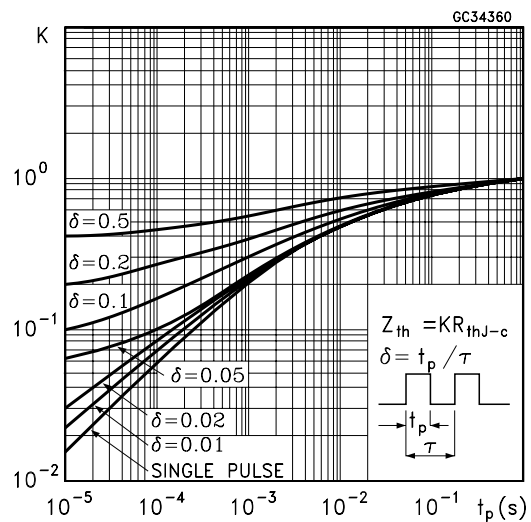
(*)Pulsed: Pulse duration = 300 μs , duty cycle 1.5 %.

(\bullet)Pulse width limited by safe operating area.

Safe Operating Area

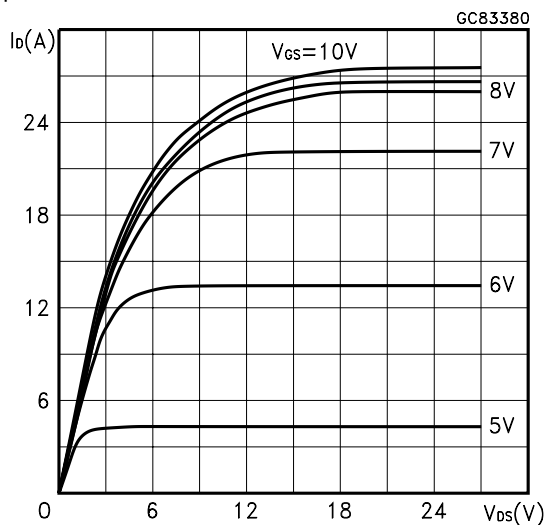


Thermal Impedance

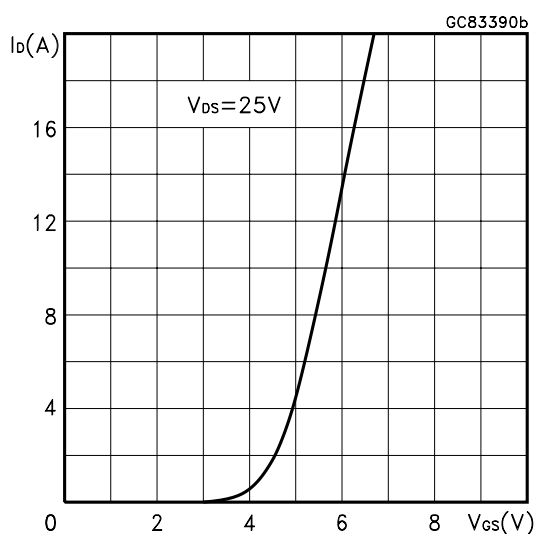


STD10PF06

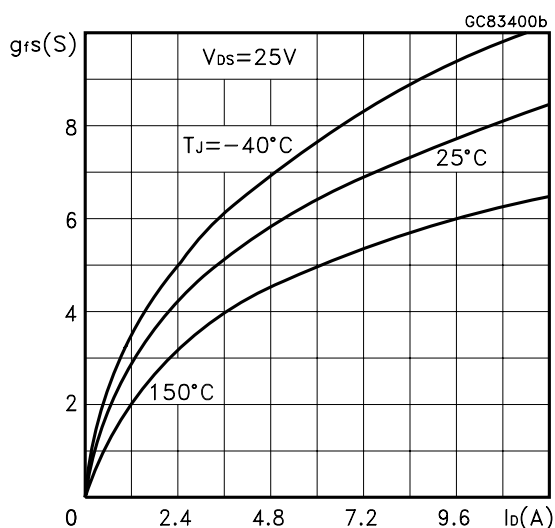
Output Characteristics



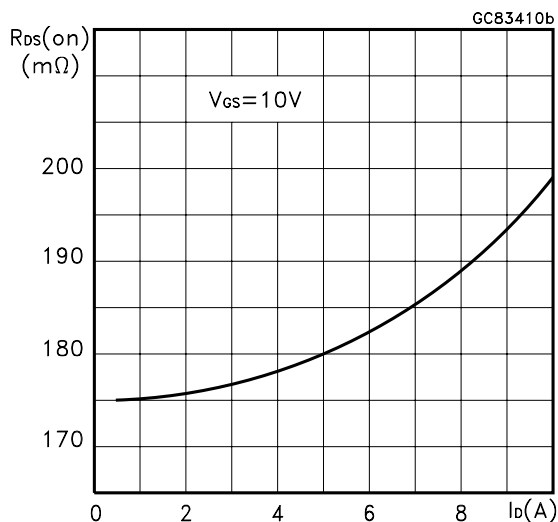
Transfer Characteristics



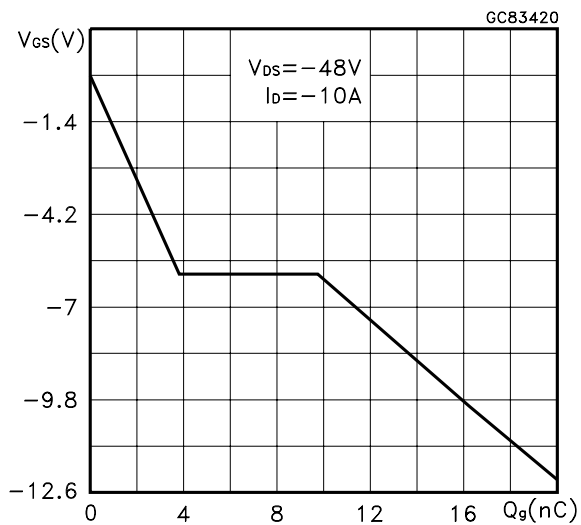
Transconductance



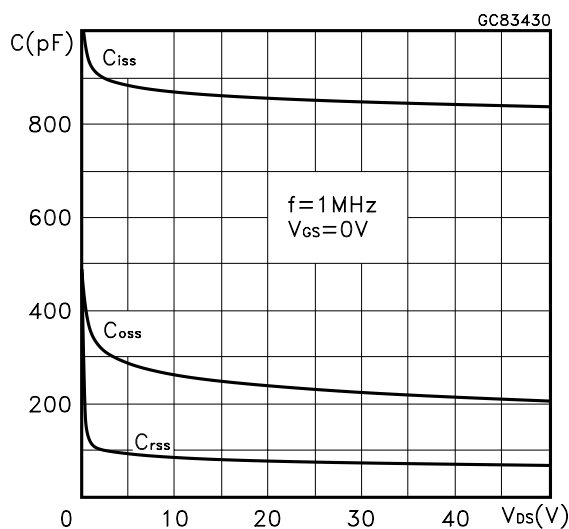
Static Drain-source On Resistance



Gate Charge vs Gate-source Voltage

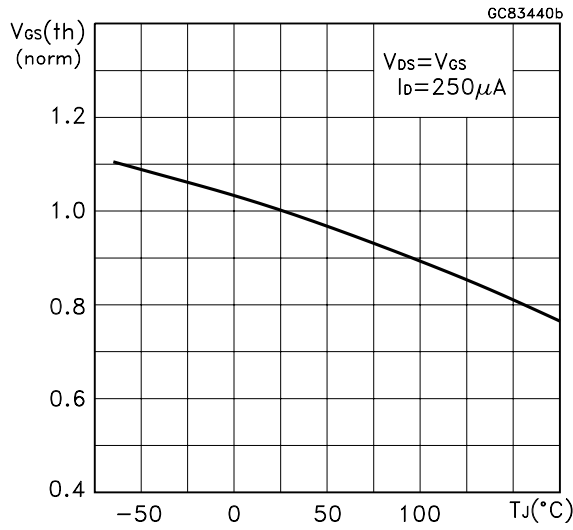


Capacitance Variations

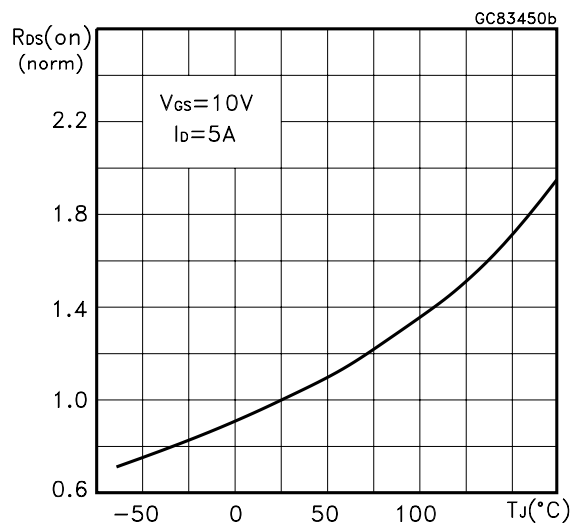


STD10PF06

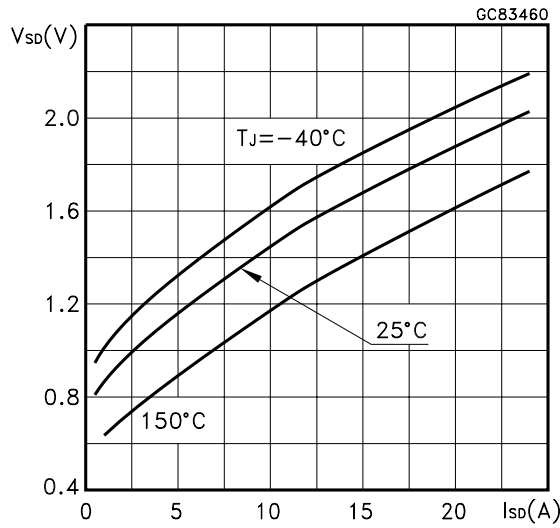
Normalized Gate Threshold Voltage vs Temperature



Normalized on Resistance vs Temperature



Source-drain Diode Forward Characteristics



Normalized Breakdown Voltage Temperature

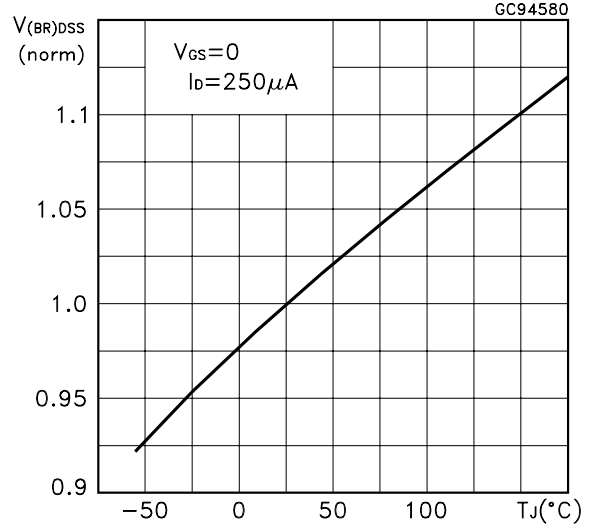


Fig. 1: Unclamped Inductive Load Test Circuit



Fig. 2: Unclamped Inductive Waveform



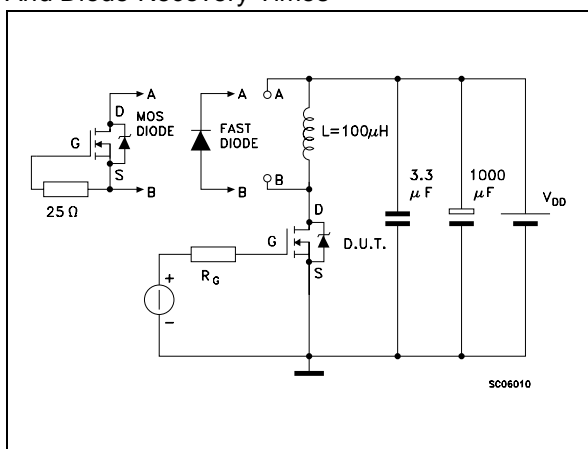
Fig. 3: Switching Times Test Circuits For Resistive Load



Fig. 4: Gate Charge test Circuit

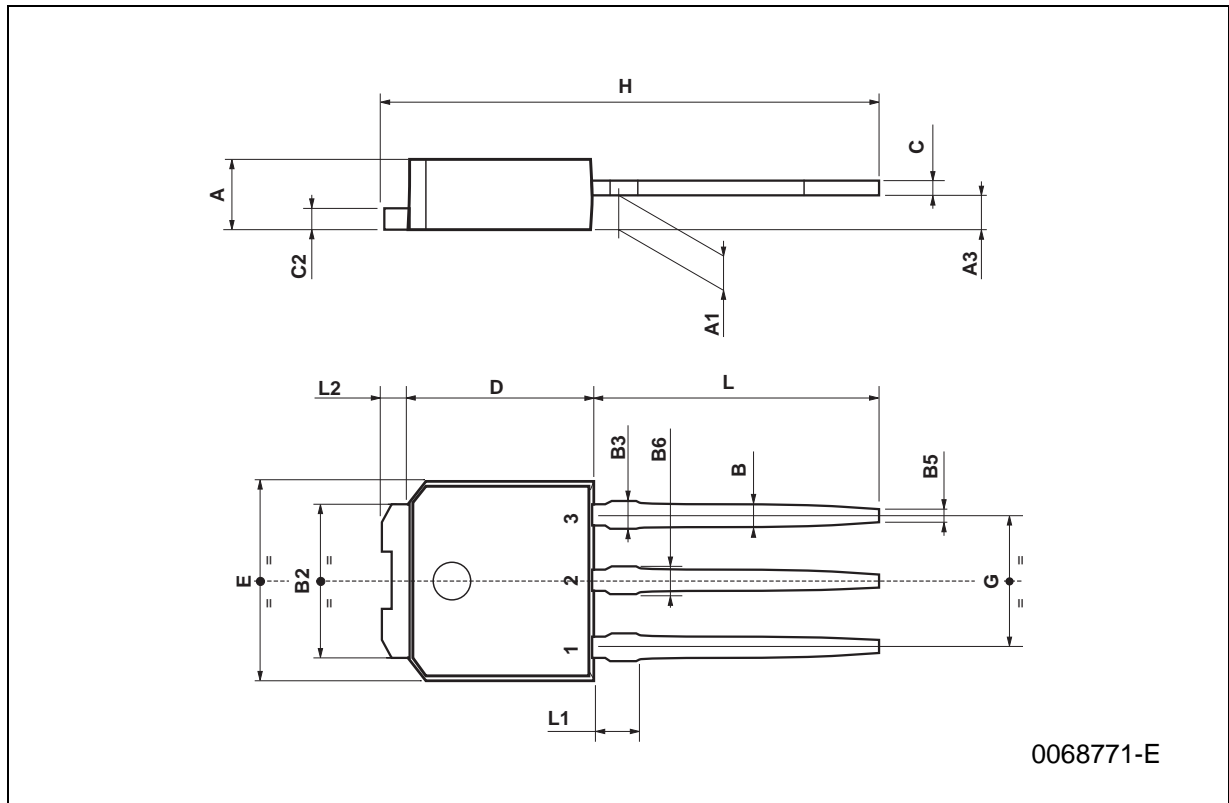


Fig. 5: Test Circuit For Inductive Load Switching And Diode Recovery Times



TO-251 (IPAK) MECHANICAL DATA

DIM.	mm			inch		
	MIN.	TYP.	MAX.	MIN.	TYP.	MAX.
A	2.2		2.4	0.086		0.094
A1	0.9		1.1	0.035		0.043
A3	0.7		1.3	0.027		0.051
B	0.64		0.9	0.025		0.031
B2	5.2		5.4	0.204		0.212
B3			0.85			0.033
B5		0.3			0.012	
B6			0.95			0.037
C	0.45		0.6	0.017		0.023
C2	0.48		0.6	0.019		0.023
D	6		6.2	0.236		0.244
E	6.4		6.6	0.252		0.260
G	4.4		4.6	0.173		0.181
H	15.9		16.3	0.626		0.641
L	9		9.4	0.354		0.370
L1	0.8		1.2	0.031		0.047
L2		0.8	1		0.031	0.039



TO-252 (DPAK) MECHANICAL DATA

DIM.	mm			inch		
	MIN.	TYP.	MAX.	MIN.	TYP.	MAX.
A	2.2		2.4	0.086		0.094
A1	0.9		1.1	0.035		0.043
A2	0.03		0.23	0.001		0.009
B	0.64		0.9	0.025		0.035
B2	5.2		5.4	0.204		0.212
C	0.45		0.6	0.017		0.023
C2	0.48		0.6	0.019		0.023
D	6		6.2	0.236		0.244
E	6.4		6.6	0.252		0.260
G	4.4		4.6	0.173		0.181
H	9.35		10.1	0.368		0.397
L2		0.8			0.031	
L4	0.6		1	0.023		0.039



Information furnished is believed to be accurate and reliable. However, STMicroelectronics assumes no responsibility for the consequences of use of such information nor for any infringement of patents or other rights of third parties which may result from its use. No license is granted by implication or otherwise under any patent or patent rights of STMicroelectronics. Specifications mentioned in this publication are subject to change without notice. This publication supersedes and replaces all information previously supplied. STMicroelectronics products are not authorized for use as critical components in life support devices or systems without express written approval of STMicroelectronics.

The ST logo is registered trademark of STMicroelectronics
© 2002 STMicroelectronics - All Rights Reserved

All other names are the property of their respective owners.

STMicroelectronics GROUP OF COMPANIES

Australia - Brazil - Canada - China - Finland - France - Germany - Hong Kong - India - Israel - Italy - Japan - Malaysia - Malta - Morocco -
Singapore - Spain - Sweden - Switzerland - United Kingdom - United States.

<http://www.st.com>

