

XLamp® XP-C LEDs

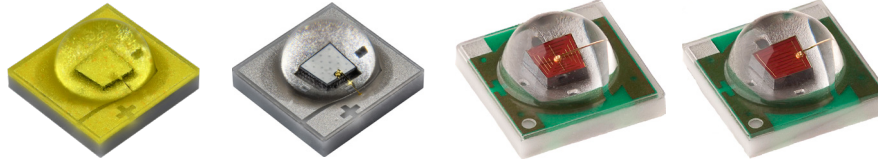

PRODUCT DESCRIPTION

The XLamp® XP-C LED combines the proven lighting-class performance and reliability of the XLamp XR-E LED in a package with 80% smaller footprint. The XLamp XP-C LED continues Cree LED’s history of innovation in LEDs for lighting applications with wide viewing angle, symmetrical package, unlimited floor life and electrically neutral thermal path.

XLamp LEDs bring high performance and quality of light to a wide range of lighting applications, including color-changing lighting, portable and personal lighting, outdoor lighting, indoor directional lighting, commercial lighting and emergency-vehicle lighting.

FEATURES

- Available in white (2600 K to 10,000 K CCT), blue, green, amber, red-orange, red
- Maximum drive current: up to 500 mA
- Low thermal resistance: as low as 11 °C/W
- Wide viewing angle: 120° - 135°
- Unlimited floor life at ≤ 30 °C/85% RH
- Reflow solderable - JEDEC J-STD-020C compatible
- Electrically neutral thermal path
- RoHS and REACH compliant
- UL® recognized component (E349212)

TABLE OF CONTENTS

Characteristics	2
Order Codes Suggested for New Designs - White	3
Order Codes Suggested for New Designs - Color.....	6
Relative Spectral Power Distribution	9
Relative Flux vs. Junction Temperature.....	10
Electrical Characteristics.....	11
Relative Flux vs. Current	12
Typical Spatial Distribution.....	13
Thermal Design	14
Performance Groups - Luminous Flux.....	17
Performance Groups - Chromaticity	18
Performance Groups - Dominant Wavelength.....	22
Performance Groups - Forward Voltage.....	22
Standard Cool White Kits Plotted on ANSI Standard Chromaticity Regions	23
Standard Warm and Neutral White Kits Plotted on ANSI Standard Chromaticity Regions	24
Standard Chromaticity Kits	25
Bin and Order Code Formats.....	25
Reflow Soldering Characteristics.....	26
Notes	27
Mechanical Dimensions	29
Tape and Reel.....	31
Packaging.....	33
Appendix - Order Codes Not For New Designs	34



Cree LED / 4001 E. Hwy. 54, Suite 2000 / Durham, NC 27709 USA / +1.919.313.5330 / www.cree-led.com

CHARACTERISTICS

Characteristics	Unit	Minimum	Typical	Maximum
Thermal resistance, junction to solder point ^o - white	°C/W		12	
Thermal resistance, junction to solder point ^o - blue	°C/W		11	
Thermal resistance, junction to solder point ^o - green	°C/W		13	
Thermal resistance, junction to solder point ^o - amber	°C/W		12.5	
Thermal resistance, junction to solder point ^o - red, red-orange	°C/W		11.5	
Viewing angle (FWHM) - white	degrees		120	
Viewing angle (FWHM) - blue, green	degrees		135	
Viewing angle (FWHM) - amber	degrees		125	
Viewing angle (FWHM) - red, red-orange	degrees		129	
Temperature coefficient of voltage - white, blue, green	mV/°C		-1.0	
Temperature coefficient of voltage - amber, red-orange, red	mV/°C		-2.0	
ESD withstand voltage (HBM per Mil-Std-883D) - white, blue, green	V			8000
ESD Classification (HBM per Mil-Std-883D) - amber, red-orange, red			Class 2	
DC forward current - white, blue, green	mA			500
DC forward current - amber, red-orange, red	mA			350
Reverse voltage	V			1
Forward voltage (@ 350 mA) - white	V		3	3.7
Forward voltage (@ 350 mA) - blue, green	V		2.9	3.7
Forward voltage (@ 350 mA) - amber	V		2.2	2.5
Forward voltage (@ 350 mA) - red-orange, red	V		2.35	2.6
Forward voltage (@ 150 mA) - blue	V		2.7	
Forward voltage (@ 100 mA) - green	V		2.55	
Forward voltage (@ 150 mA) - red-orange, red	V		2.1	
Forward voltage (@ 125 mA) - amber	V		2.1	
Forward voltage (@ 500 mA) - white	V		3.1	
Forward voltage (@ 500 mA) - blue	V		3.0	
Forward voltage (@ 500 mA) - green	V		3.05	
LED junction temperature	°C			150

Note:

- ◇ Thermal resistance measurement was performed per the JEDEC JESD51-14 standard. See the [Thermal Resistance Measurement application note](#) for more details.

ORDER CODES SUGGESTED FOR NEW DESIGNS - WHITE ($T_j = 25\text{ }^\circ\text{C}$)

The following tables provide order codes for XLamp XP-C white LEDs. For a complete description of the order code nomenclature, please see the Bin and Order Code Formats section (page 25).

Minimum Luminous Flux (lm) @ 350 mA		Chromaticity Regions	Order Codes
Group	Flux (lm)		
R5	139	WA, WB, WC, WD, WE, WF, WG, WH, WJ, WK, WM, WN, WP	XPCWHT-L1-0000-00H01
		WC, WD, WF, WG	XPCWHT-L1-0000-00H02
		WC, WD, WF, WG, WH, WJ, WN, WP	XPCWHT-L1-0000-00H03
S2	148	WA, WB, WC, WD, WE, WF, WG, WH, WJ, WK, WM, WN, WP	XPCWHT-L1-0000-00J01
		WC, WD, WF, WG	XPCWHT-L1-0000-00J02
		WC, WD, WF, WG, WH, WJ, WN, WP	XPCWHT-L1-0000-00J03
S3	156	WA, WB, WC, WD, WE, WF, WG, WH, WJ, WK, WM, WN, WP	XPCWHT-L1-0000-00K01
		WC, WD, WF, WG	XPCWHT-L1-0000-00K02
		WC, WD, WF, WG, WH, WJ, WN, WP	XPCWHT-L1-0000-00K03

Notes:

- Cree LED maintains a tolerance of $\pm 7\%$ on flux and power measurements, ± 0.005 on chromaticity (CCx, CCy) measurements and a tolerance of ± 2 on CRI measurements. See the Measurements section (page 27).
- XLamp XP-C LED order codes specify only a minimum flux bin and not a maximum. Cree LED may ship reels in flux bins higher than the minimum specified by the order code without advance notice. Shipments will always adhere to the chromaticity bin restrictions specified by the order code.

ORDER CODES SUGGESTED FOR NEW DESIGNS - WHITE ($T_j = 25\text{ }^\circ\text{C}$) - CONTINUED

The following tables provide order codes for XLamp XP-C white LEDs. For a complete description of the order code nomenclature, please see the Bin and Order Code Formats section (page 25). For definitions of the chromaticity kits, please see the Standard Chromaticity Kits section (page 25).

Chromaticity		Minimum Luminous Flux (lm) @ 350 mA		Order Codes
Kit	CCT	Code	Flux (lm)	70 CRI Typical
51	6200 K	S3	156	XPCWHT-L1-0000-00K51
		S2	148	XPCWHT-L1-0000-00J51
		R5	139	XPCWHT-L1-0000-00H51
53	6000 K	S3	156	XPCWHT-L1-0000-00K53
		S2	148	XPCWHT-L1-0000-00J53
		R5	139	XPCWHT-L1-0000-00H53
50	6200 K	S3	156	XPCWHT-L1-0000-00K50
		S2	148	XPCWHT-L1-0000-00J50
		R5	139	XPCWHT-L1-0000-00H50
E1	6500 K	S3	156	XPCWHT-L1-0000-00KE1
		S2	148	XPCWHT-L1-0000-00JE1
		R5	139	XPCWHT-L1-0000-00HE1
E2	5700 K	S3	156	XPCWHT-L1-0000-00KE2
		S2	148	XPCWHT-L1-0000-00JE2
		R5	139	XPCWHT-L1-0000-00HE2
E3	5000 K	S3	156	XPCWHT-L1-0000-00KE3
		S2	148	XPCWHT-L1-0000-00JE3
		R5	139	XPCWHT-L1-0000-00HE3
F4	4750 K	S3	156	XPCWHT-L1-0000-00KF4
		S2	148	XPCWHT-L1-0000-00JF4
		R5	139	XPCWHT-L1-0000-00HF4
E4	4500 K	S3	156	XPCWHT-L1-0000-00KE4
		S2	148	XPCWHT-L1-0000-00JE4
		R5	139	XPCWHT-L1-0000-00HE4
F5	4250 K	S3	156	XPCWHT-L1-0000-00KF5
		S2	148	XPCWHT-L1-0000-00JF5
		R5	139	XPCWHT-L1-0000-00HF5
		R4	130	XPCWHT-L1-0000-00GF5
E5	4000 K	S3	156	XPCWHT-L1-0000-00KE5
		S2	148	XPCWHT-L1-0000-00JE5
		R5	139	XPCWHT-L1-0000-00HE5
		R4	130	XPCWHT-L1-0000-00GE5

Notes:

- Cree LED maintains a tolerance of $\pm 7\%$ on flux and power measurements, ± 0.005 on chromaticity (CCx, CCy) measurements and a tolerance of ± 2 on CRI measurements. See the Measurements section (page 27).
- XLamp XP-C LED order codes specify only a minimum flux bin and not a maximum. Cree LED may ship reels in flux bins higher than the minimum specified by the order code without advance notice. Shipments will always adhere to the chromaticity bin restrictions specified by the order code.

ORDER CODES SUGGESTED FOR NEW DESIGNS - WHITE ($T_j = 25\text{ }^\circ\text{C}$) - CONTINUED

Chromaticity		Minimum Luminous Flux (lm) @ 350 mA		Order Codes
Kit	CCT	Code	Flux (lm)	70 CRI Typical
F6	3750 K	S2	148	XPCWHT-L1-0000-00JF6
		R5	139	XPCWHT-L1-0000-00HF6
		R4	130	XPCWHT-L1-0000-00GF6
E6	3500 K	S2	148	XPCWHT-L1-0000-00JE6
		R5	139	XPCWHT-L1-0000-00HE6
		R4	130	XPCWHT-L1-0000-00GE6
F7	3250 K	R5	139	XPCWHT-L1-0000-00HF7
		R4	130	XPCWHT-L1-0000-00GF7
		R3	122	XPCWHT-L1-0000-00FF7
E7	3000 K	R5	139	XPCWHT-L1-0000-00HE7
		R4	130	XPCWHT-L1-0000-00GE7
		R3	122	XPCWHT-L1-0000-00FE7
F8	2850 K	R5	139	XPCWHT-L1-0000-00HF8
		R4	130	XPCWHT-L1-0000-00GF8
		R3	122	XPCWHT-L1-0000-00FF8
E8	2700 K	R5	139	XPCWHT-L1-0000-00HE8
		R4	130	XPCWHT-L1-0000-00GE8
		R3	122	XPCWHT-L1-0000-00FE8

Notes:

- Cree LED maintains a tolerance of $\pm 7\%$ on flux and power measurements, ± 0.005 on chromaticity (CCx, CCy) measurements and a tolerance of ± 2 on CRI measurements. See the Measurements section (page 27).
- XLamp XP-C LED order codes specify only a minimum flux bin and not a maximum. Cree LED may ship reels in flux bins higher than the minimum specified by the order code without advance notice. Shipments will always adhere to the chromaticity bin restrictions specified by the order code.

ORDER CODES SUGGESTED FOR NEW DESIGNS - COLOR (T_j = 25 °C)

The following tables provide order codes for XLamp XP-C color LEDs. For a complete description of the order code nomenclature, please see the Bin and Order Code Formats section (page 25).

Color	Minimum Luminous Flux (@ 350 mA)		Calculated Minimum Luminous Flux @ 150 mA*	Dominant Wavelength (nm)				Order Codes
	Group	Flux (lm)		Minimum		Maximum		
			Group	DWL (nm)	Group	DWL (nm)		
Blue	K3	35.2	18.2	B3	465	B6	485	XPCBLU-L1-0000-00Z01
				20.6	465	B5	480	XPCBLU-L1-0000-00Z02
				23.6	470	B5	480	XPCBLU-L1-0000-00Z05
	M2	39.8	20.6	B3	465	B6	485	XPCBLU-L1-0000-00201
				B3	465	B5	480	XPCBLU-L1-0000-00202
				B4	470	B5	480	XPCBLU-L1-0000-00205
	M3	45.7	23.6	B3	465	B6	485	XPCBLU-L1-0000-00301
				B3	465	B5	480	XPCBLU-L1-0000-00302
				B4	470	B5	480	XPCBLU-L1-0000-00305

Color	Minimum Luminous Flux (@ 350 mA)		Calculated Minimum Luminous Flux @ 100 mA*	Dominant Wavelength (nm)				Order Codes
	Group	Flux (lm)		Minimum		Maximum		
			Group	DWL (nm)	Group	DWL (nm)		
Green	Q3	93.9	38.7	G2	520	G4	535	XPCGRN-L1-0000-00B01
				G2	520	G3	530	XPCGRN-L1-0000-00B02
				G3	525	G4	535	XPCGRN-L1-0000-00B03
	Q4	100	41.2	G2	520	G4	535	XPCGRN-L1-0000-00C01
				G2	520	G3	530	XPCGRN-L1-0000-00C02
				G3	525	G4	535	XPCGRN-L1-0000-00C03
	Q5	107	44.1	G2	520	G4	535	XPCGRN-L1-0000-00D01
				G2	520	G3	530	XPCGRN-L1-0000-00D02
				G3	525	G4	535	XPCGRN-L1-0000-00D03
	R2	114	47.0	G2	520	G4	535	XPCGRN-L1-0000-00E01
				G2	520	G3	530	XPCGRN-L1-0000-00E02
				G3	525	G4	535	XPCGRN-L1-0000-00E03
	R3	122	50.3	G2	520	G4	535	XPCGRN-L1-0000-00F01
				G2	520	G3	530	XPCGRN-L1-0000-00F02
				G3	525	G4	535	XPCGRN-L1-0000-00F03

Notes:

- Cree LED maintains a tolerance of ±7% on flux and power measurements, ±0.005 on chromaticity (CCx, CCy) measurements and a tolerance of ±2 on CRI measurements. See the Measurements section (page 27).
- XLamp XP-C LED order codes specify only a minimum flux bin and not a maximum. Cree LED may ship reels in flux bins higher than the minimum specified by the order code without advance notice. Shipments will always adhere to the chromaticity bin restrictions specified by the order code.
- * Flux values at 125 mA are calculated and for reference only.

ORDER CODES SUGGESTED FOR NEW DESIGNS - COLOR (T_j = 25 °C) - CONTINUED

Color	Minimum Luminous Flux (@ 350 mA)		Calculated Minimum Luminous Flux @ 125 mA*	Dominant Wavelength (nm)				Order Codes
	Group	Flux (lm)		Minimum		Maximum		
			Group	DWL (nm)	Group	DWL (nm)		
Amber	M2	39.8	14.9	A2	585	A3	595	XPCAMB-L1-0000-00201
				A3	590	A3	595	XPCAMB-L1-0000-00203
	M3	45.7	17.1	A2	585	A3	595	XPCAMB-L1-0000-00301
				A3	590	A3	595	XPCAMB-L1-0000-00303
	N2	51.7	19.4	A2	585	A3	595	XPCAMB-L1-0000-00401
				A3	590	A3	595	XPCAMB-L1-0000-00403
	N3	56.8	21.3	A2	585	A3	595	XPCAMB-L1-0000-00501
				A3	590	A3	595	XPCAMB-L1-0000-00503
	N4	62.0	23.3	A2	585	A3	595	XPCAMB-L1-0000-00601
				A3	590	A3	595	XPCAMB-L1-0000-00603

Color	Minimum Luminous Flux (@ 350 mA)		Calculated Minimum Luminous Flux @ 125 mA*	Dominant Wavelength (nm)				Order Codes
	Group	Flux (lm)		Minimum		Maximum		
			Group	DWL (nm)	Group	DWL (nm)		
Red-Orange	P3	73.9	26.0	O3	610	O4	620	XPCRDO-L1-0000-00801
				O3	610	O3	615	XPCRDO-L1-0000-00802
				O4	615	O4	620	XPCRDO-L1-0000-00803
	P4	80.6	28.3	O3	610	O4	620	XPCRDO-L1-0000-00901
				O3	610	O3	615	XPCRDO-L1-0000-00902
				O4	615	O4	620	XPCRDO-L1-0000-00903
	Q2	87.4	30.7	O3	610	O4	620	XPCRDO-L1-0000-00A01
				O3	610	O3	615	XPCRDO-L1-0000-00A02
				O4	615	O4	620	XPCRDO-L1-0000-00A03

Notes:

- Cree LED maintains a tolerance of ±7% on flux and power measurements, ±0.005 on chromaticity (CCx, CCy) measurements and a tolerance of ±2 on CRI measurements. See the Measurements section (page 27).
- XLamp XP-C LED order codes specify only a minimum flux bin and not a maximum. Cree LED may ship reels in flux bins higher than the minimum specified by the order code without advance notice. Shipments will always adhere to the chromaticity bin restrictions specified by the order code.
- * Flux values at 125 mA are calculated and for reference only.

ORDER CODES SUGGESTED FOR NEW DESIGNS - COLOR (T_j = 25 °C) - CONTINUED

Color	Minimum Luminous Flux (@ 350 mA)		Calculated Minimum Luminous Flux @ 125 mA*	Dominant Wavelength (nm)				Order Codes
	Group	Flux (lm)		Minimum		Maximum		
			Group	DWL (nm)	Group	DWL (nm)		
Red	N4	62.0	21.5	R2	620	R3	630	XPCRED-L1-0000-00601
				R2	620	R2	625	XPCRED-L1-0000-00602
	P2	67.2	23.3	R2	620	R3	630	XPCRED-L1-0000-00701
				R2	620	R2	625	XPCRED-L1-0000-00702
	P3	73.9	25.6	R2	620	R3	630	XPCRED-L1-0000-00801
				R2	620	R2	625	XPCRED-L1-0000-00802

Notes:

- Cree LED maintains a tolerance of ±7% on flux and power measurements, ±0.005 on chromaticity (CCx, CCy) measurements and a tolerance of ±2 on CRI measurements. See the Measurements section (page 27).
- XLamp XP-C LED order codes specify only a minimum flux bin and not a maximum. Cree LED may ship reels in flux bins higher than the minimum specified by the order code without advance notice. Shipments will always adhere to the chromaticity bin restrictions specified by the order code.
- * Flux values at 125 mA are calculated and for reference only.

RELATIVE SPECTRAL POWER DISTRIBUTION

White

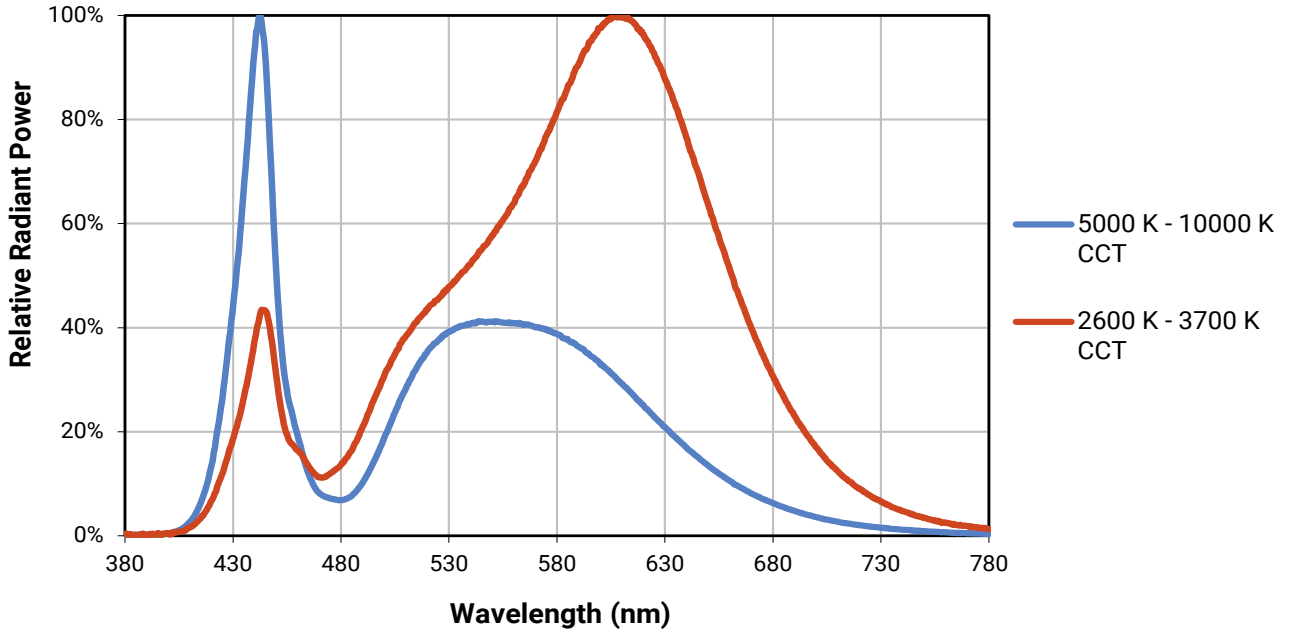

Color

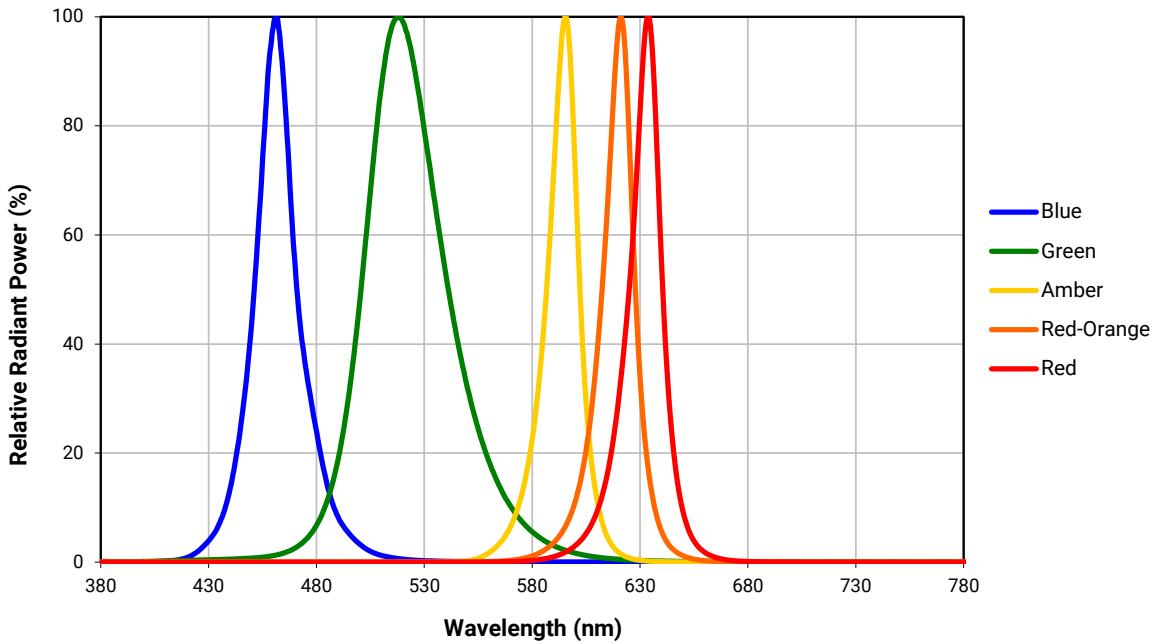

RELATIVE FLUX VS. JUNCTION TEMPERATURE ($I_f = 350 \text{ mA}$)

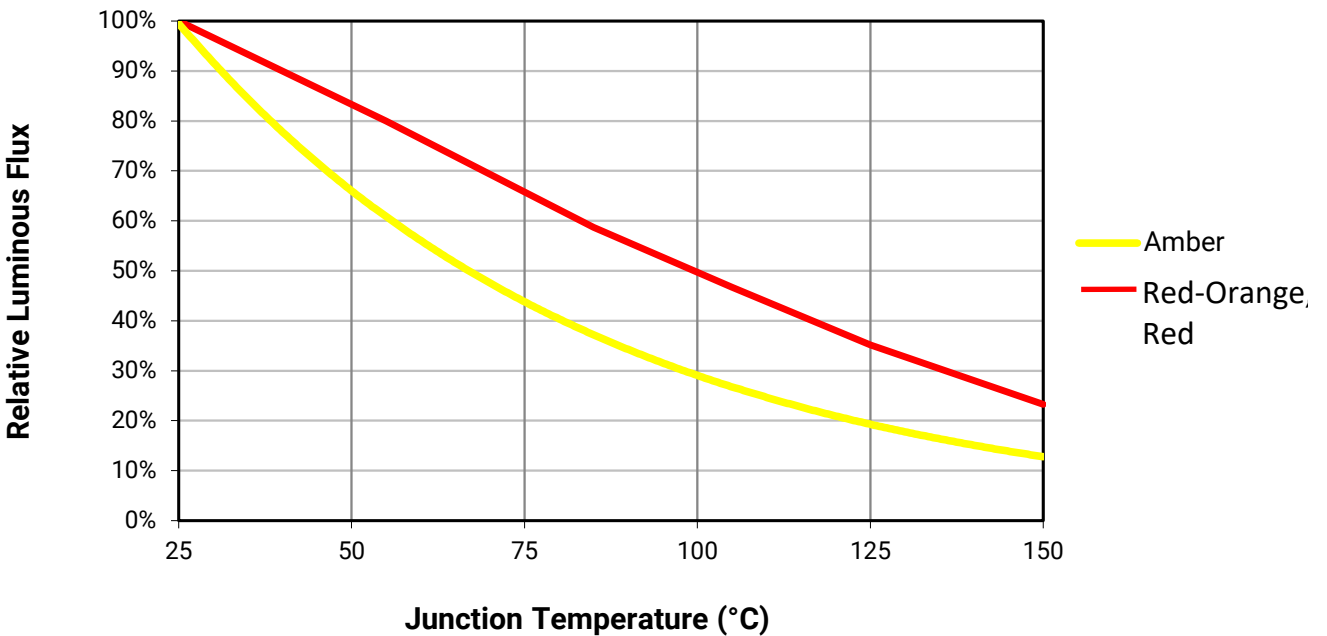
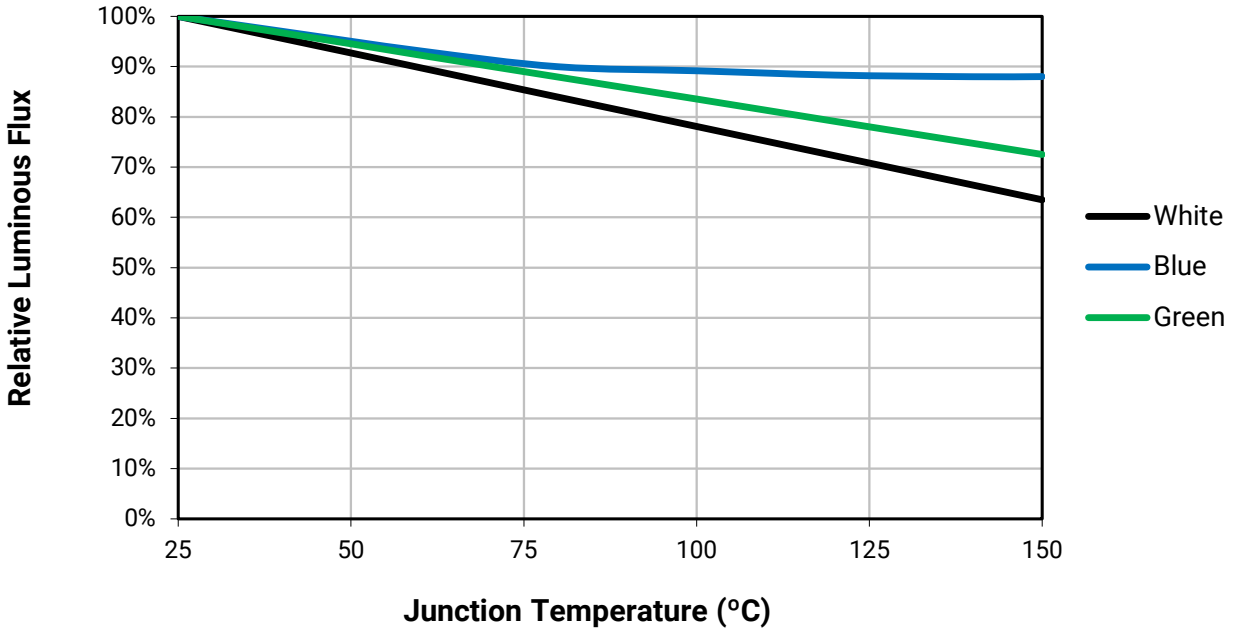

ELECTRICAL CHARACTERISTICS ($T_j = 25\text{ }^\circ\text{C}$)

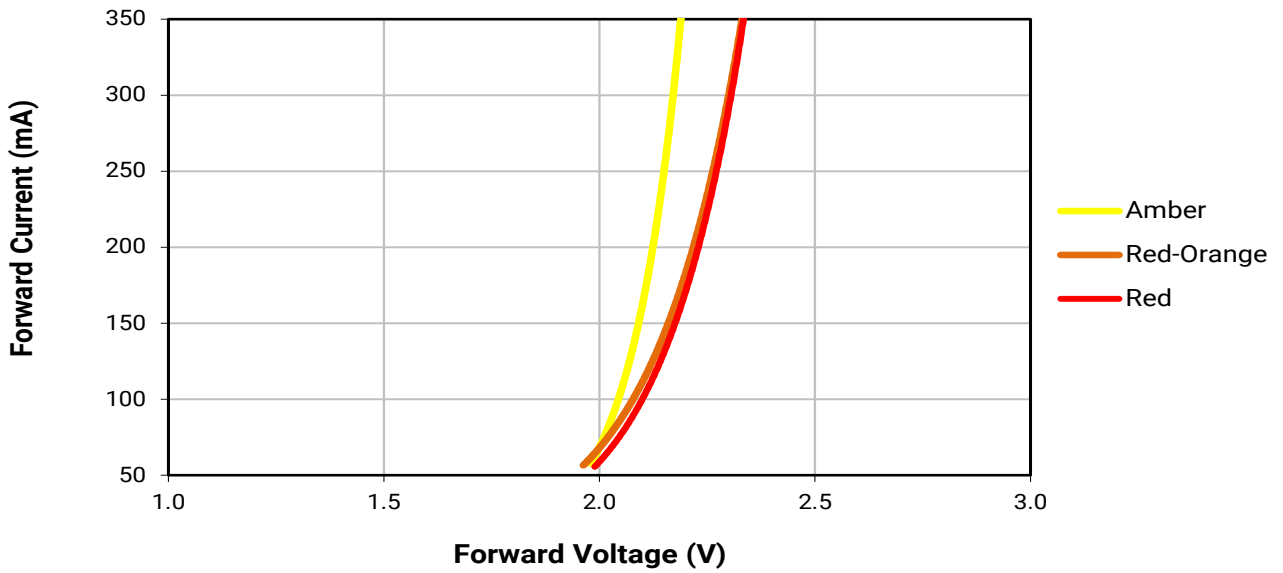
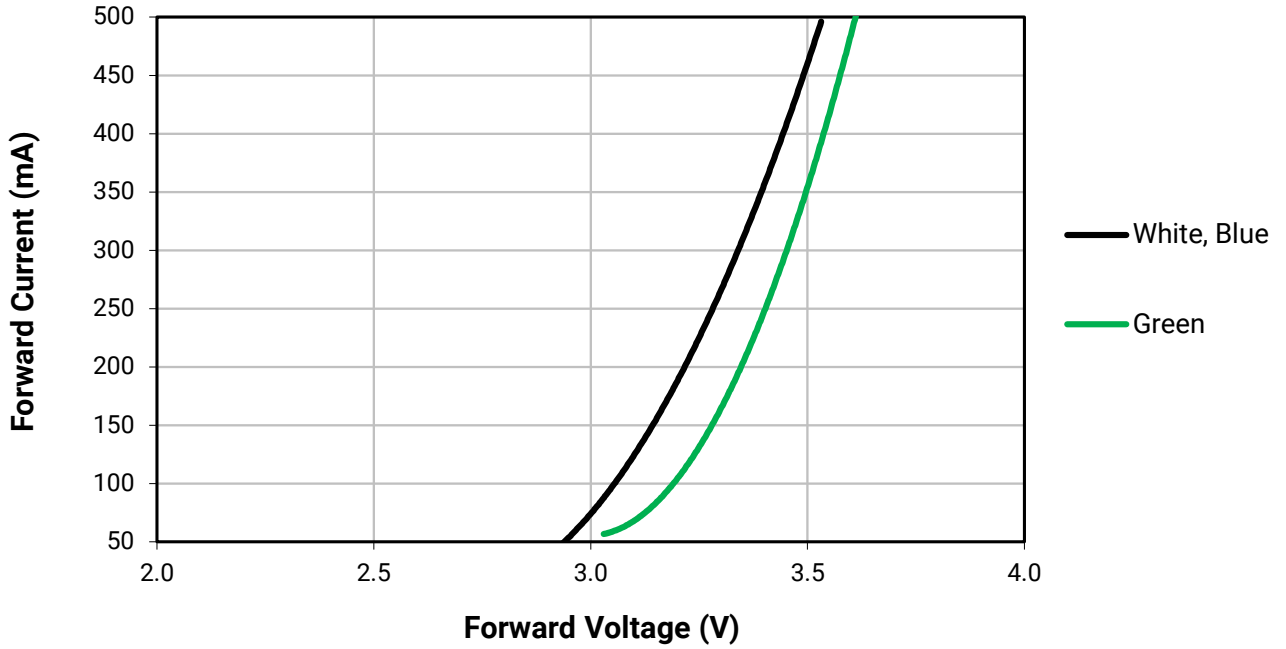

RELATIVE FLUX VS. CURRENT ($T_j = 25\text{ }^\circ\text{C}$)

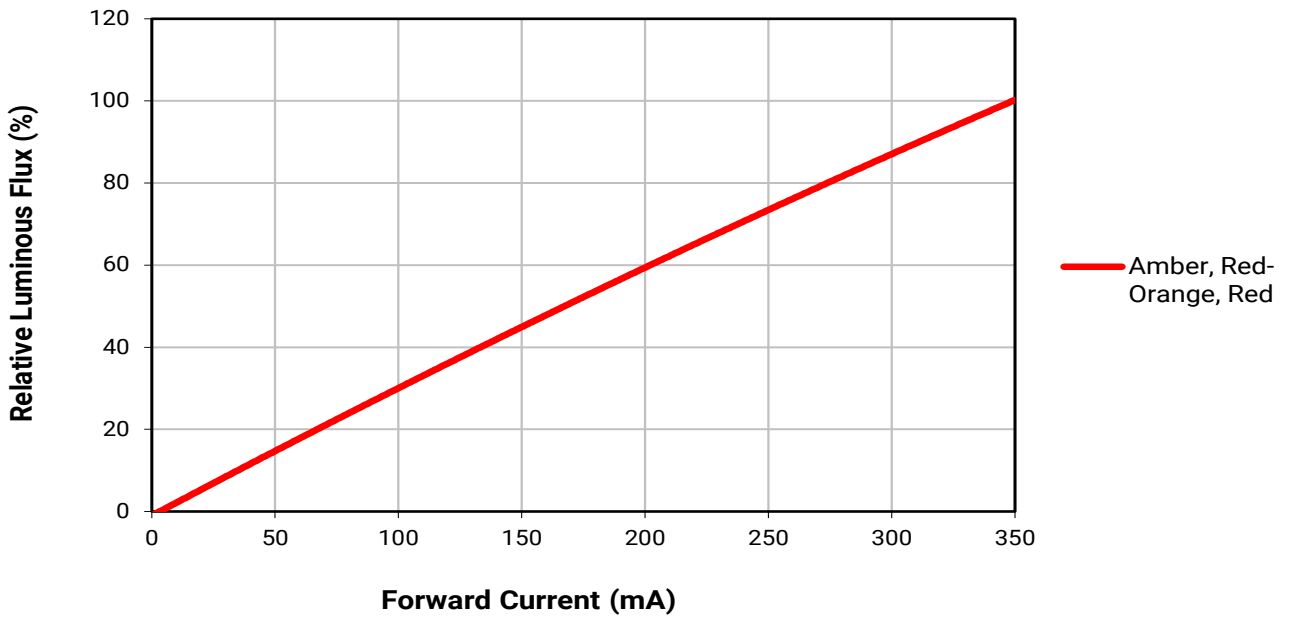
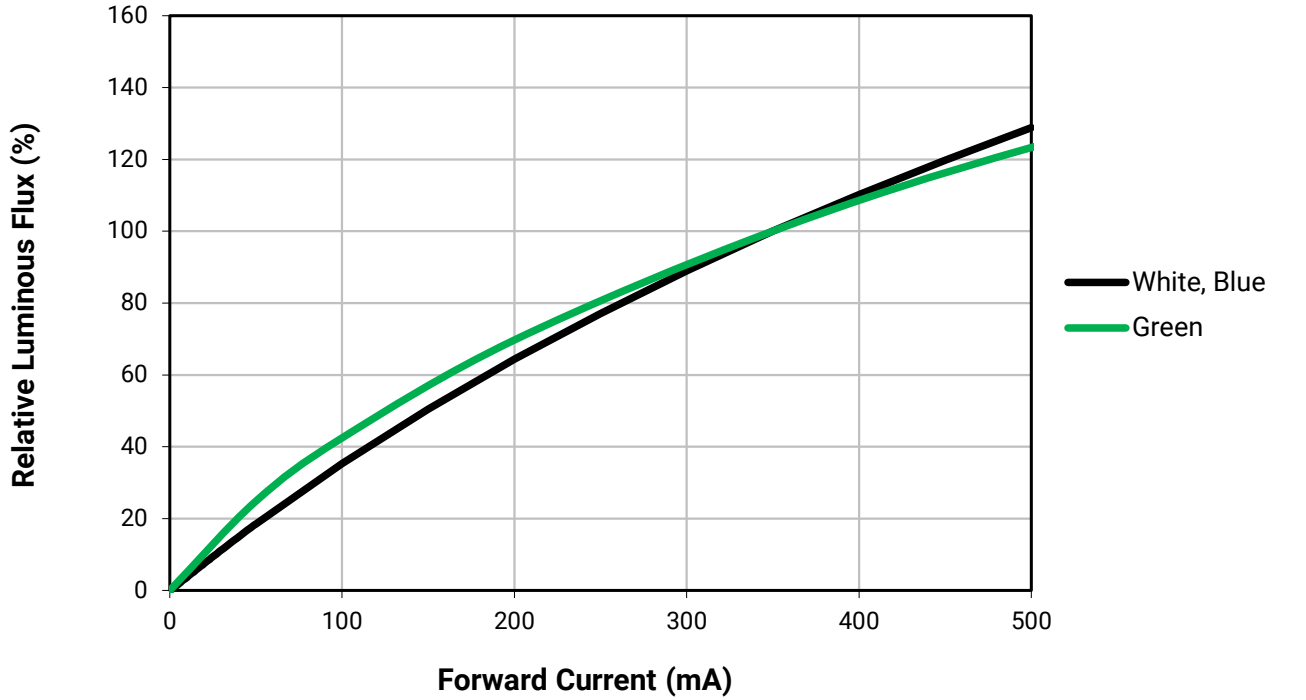

TYPICAL SPATIAL DISTRIBUTION

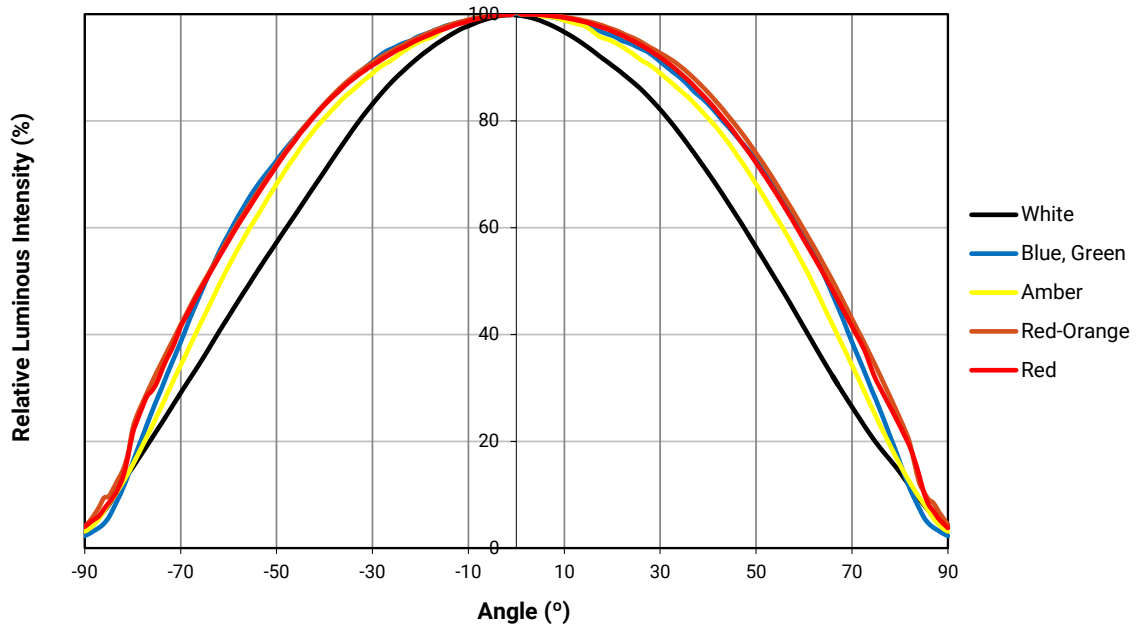

THERMAL DESIGN

The maximum forward current is determined by the thermal resistance between the LED junction and ambient. It is crucial for the end product to be designed in a manner that minimizes the thermal resistance from the solder point to ambient in order to optimize lamp life and optical characteristics.

White

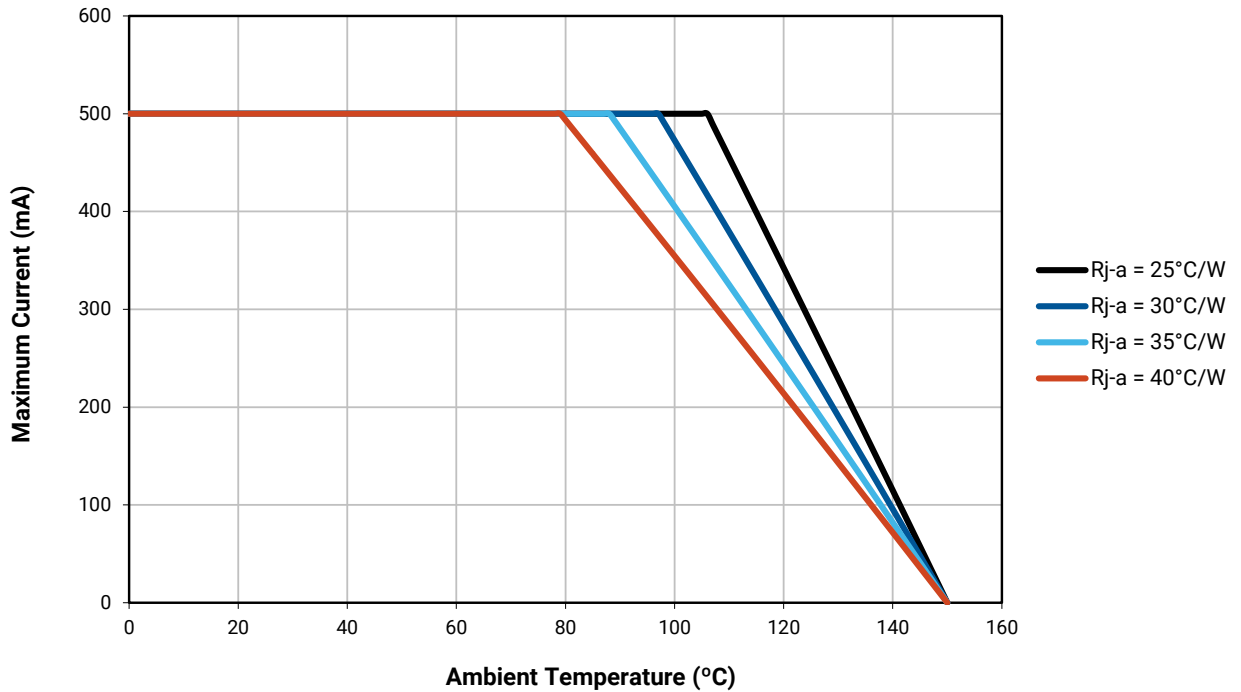

Blue

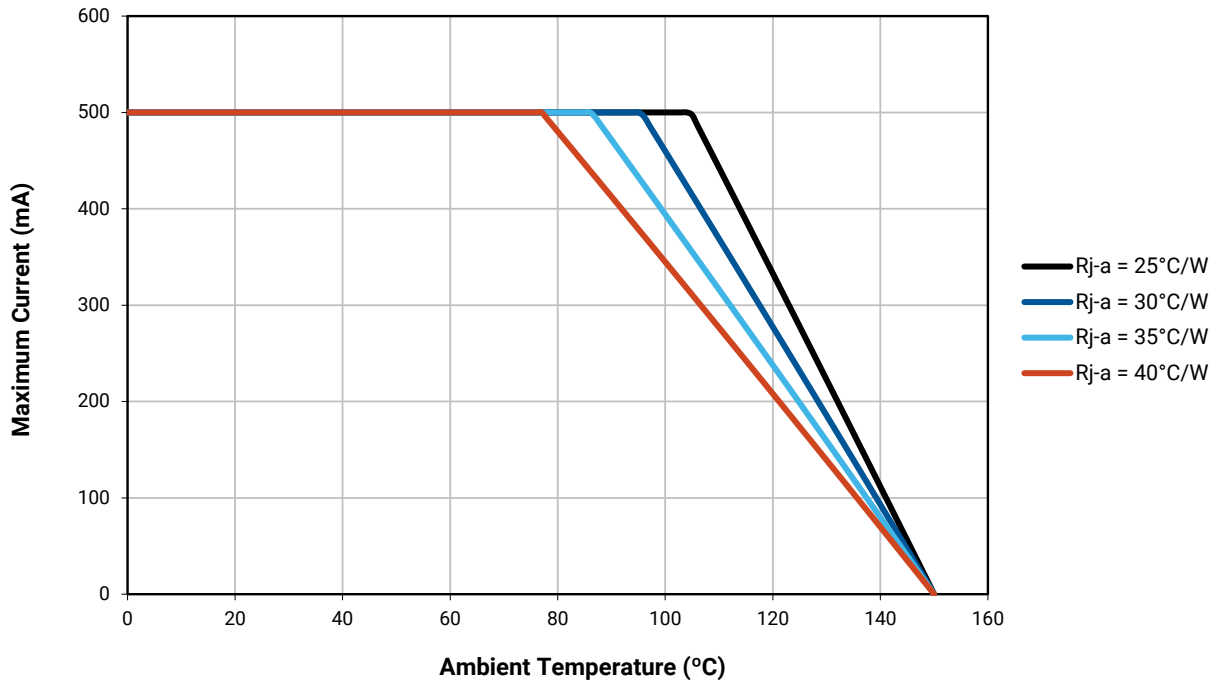

THERMAL DESIGN - CONTINUED

Green

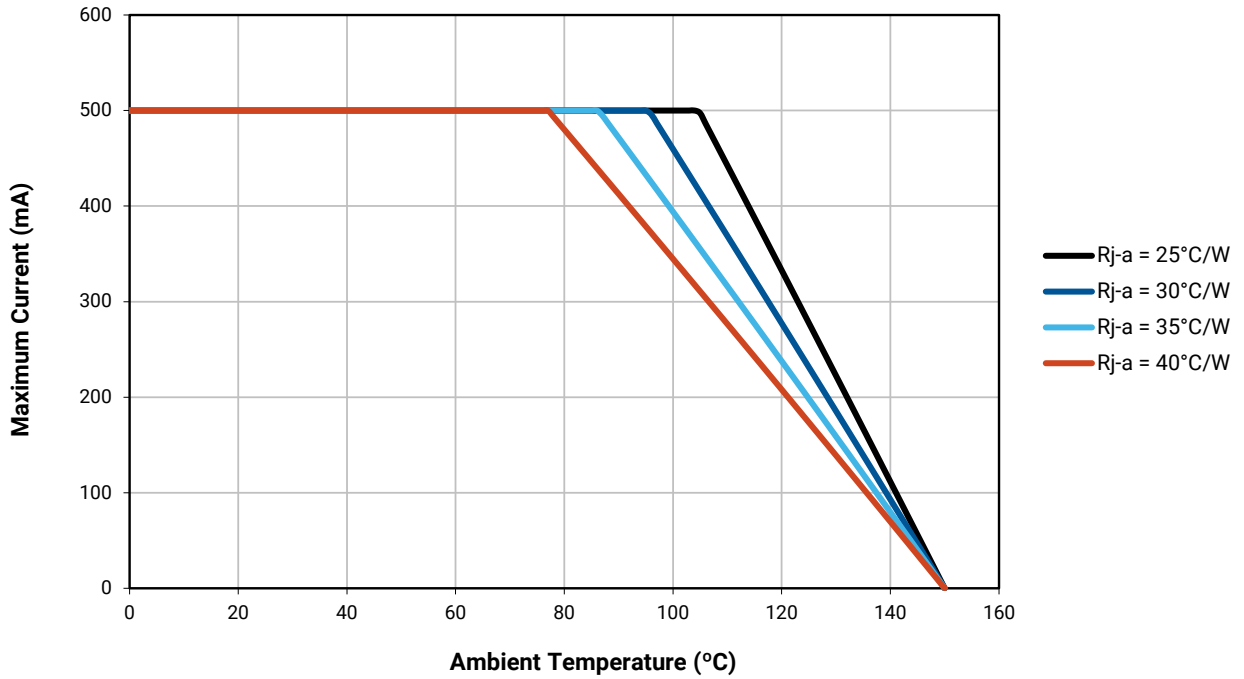

Amber

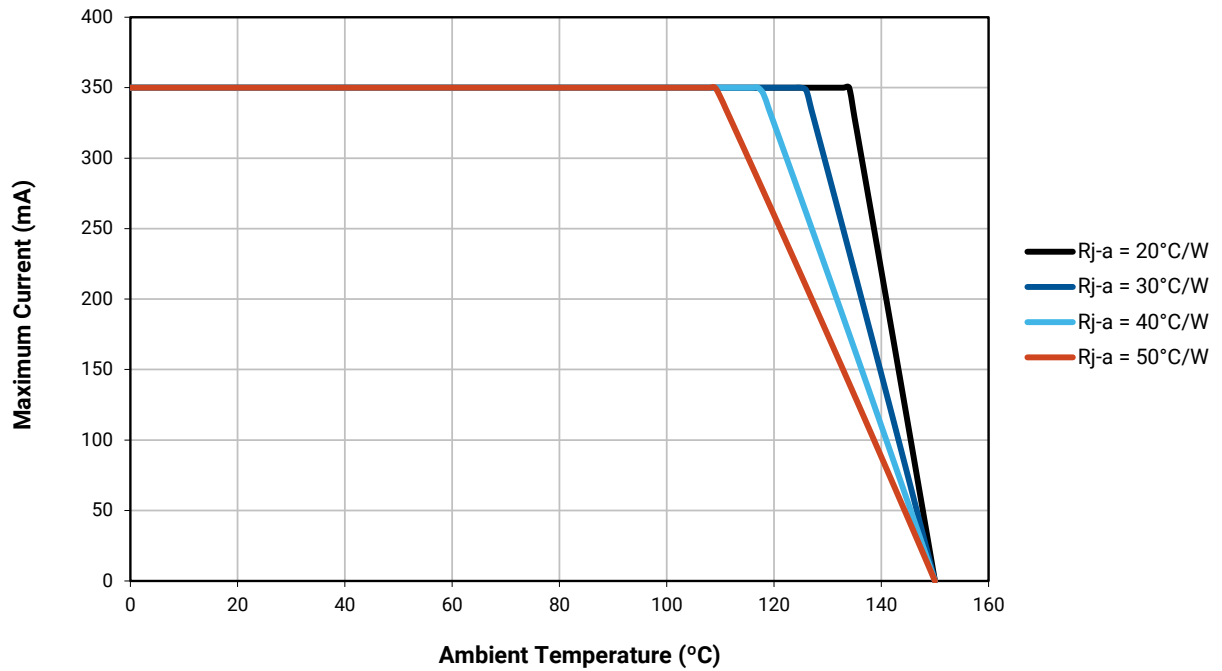

THERMAL DESIGN - CONTINUED

Red-Orange, Red

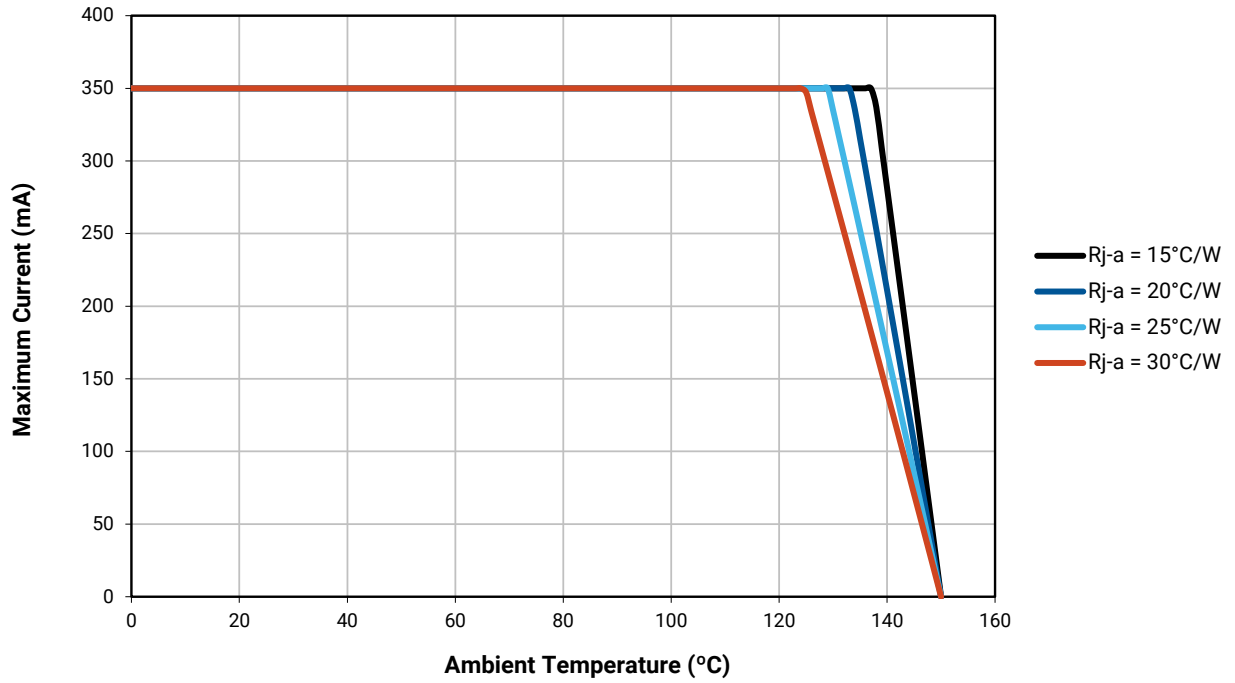

PERFORMANCE GROUPS - LUMINOUS FLUX

XLamp XP-C LEDs are tested for luminous flux and placed into one of the following luminous-flux groups:

Group Code	Minimum Luminous Flux (lm) @ 350 mA	Maximum Luminous Flux (lm) @ 350 mA
J	23.5	30.6
K2	30.6	35.2
K3	35.2	39.8
M2	39.8	45.7
M3	45.7	51.7
N2	51.7	56.8
N3	56.8	62.0
N4	62.0	67.2
P2	67.2	73.9
P3	73.9	80.6
P4	80.6	87.4
Q2	87.4	93.9
Q3	93.9	100
Q4	100	107
Q5	107	114
R2	114	122
R3	122	130
R4	130	139
R5	139	148
S2	148	156
S3	156	164
S4	164	172
S5	172	180

PERFORMANCE GROUPS - CHROMATICITY

White XLamp XP-C LEDs are tested for chromaticity and placed into one of the regions defined by the bounding coordinates on the following pages.

Region	x	y	Region	x	y
WK	.283	.284	WF	.314	.355
	.295	.297		.316	.332
	.298	.288		.306	.322
	.287	.276		.301	.342
WA	.292	.306	WP	.317	.319
	.295	.297		.329	.330
	.283	.284		.329	.318
	.279	.291		.318	.308
WM	.295	.297	WD	.329	.345
	.308	.311		.329	.330
	.310	.300		.317	.319
	.298	.288		.316	.332
WB	.306	.322	WG	.329	.369
	.308	.311		.329	.345
	.295	.297		.316	.332
	.292	.306		.314	.355
WE	.301	.342	WJ	.329	.330
	.306	.322		.329	.345
	.292	.306		.346	.359
	.287	.321		.344	.342
WN	.308	.311	WH	.348	.384
	.317	.319		.346	.359
	.318	.308		.329	.345
	.310	.300		.329	.369
WC	.316	.332			
	.317	.319			
	.308	.311			
	.306	.322			

PERFORMANCE GROUPS - CHROMATICITY (CONTINUED)

Region	x	y	Region	x	y	Region	x	y	Region	x	y
0A	0.2950	0.2970	0B	0.2920	0.3060	0C	0.2984	0.3133	0D	0.2984	0.3133
	0.2920	0.3060		0.2895	0.3135		0.2962	0.3220		0.3048	0.3207
	0.2984	0.3133		0.2962	0.3220		0.3028	0.3304		0.3068	0.3113
	0.3009	0.3042		0.2984	0.3133		0.3048	0.3207		0.3009	0.3042
0R	0.2980	0.2880	0S	0.2895	0.3135	0T	0.2962	0.3220	0U	0.3037	0.2937
	0.2950	0.2970		0.2870	0.3210		0.2937	0.3312		0.3009	0.3042
	0.3009	0.3042		0.2937	0.3312		0.3005	0.3415		0.3068	0.3113
	0.3037	0.2937		0.2962	0.3220		0.3028	0.3304		0.3093	0.2993
1A	0.3048	0.3207	1B	0.3028	0.3304	1C	0.3115	0.3391	1D	0.3130	0.3290
	0.3130	0.3290		0.3115	0.3391		0.3205	0.3481		0.3213	0.3373
	0.3144	0.3186		0.3130	0.3290		0.3213	0.3373		0.3221	0.3261
	0.3068	0.3113		0.3048	0.3207		0.3130	0.3290		0.3144	0.3186
1R	0.3068	0.3113	1S	0.3005	0.3415	1T	0.3099	0.3509	1U	0.3144	0.3186
	0.3144	0.3186		0.3099	0.3509		0.3196	0.3602		0.3221	0.3261
	0.3161	0.3059		0.3115	0.3391		0.3205	0.3481		0.3231	0.3120
	0.3093	0.2993		0.3028	0.3304		0.3115	0.3391		0.3161	0.3059
2A	0.3215	0.3350	2B	0.3207	0.3462	2C	0.3290	0.3538	2D	0.3290	0.3417
	0.3290	0.3417		0.3290	0.3538		0.3376	0.3616		0.3371	0.3490
	0.3290	0.3300		0.3290	0.3417		0.3371	0.3490		0.3366	0.3369
	0.3222	0.3243		0.3215	0.3350		0.3290	0.3417		0.3290	0.3300
2R	0.3222	0.3243	2S	0.3196	0.3602	2T	0.3290	0.3690	2U	0.3290	0.3300
	0.3290	0.3300		0.3290	0.3690		0.3381	0.3762		0.3366	0.3369
	0.3290	0.3180		0.3290	0.3538		0.3376	0.3616		0.3361	0.3245
	0.3231	0.3120		0.3207	0.3462		0.3290	0.3538		0.3290	0.3180
3A	0.3371	0.3490	3B	0.3376	0.3616	3C	0.3463	0.3687	3D	0.3451	0.3554
	0.3451	0.3554		0.3463	0.3687		0.3551	0.3760		0.3533	0.3620
	0.3440	0.3427		0.3451	0.3554		0.3533	0.3620		0.3515	0.3487
	0.3366	0.3369		0.3371	0.3490		0.3451	0.3554		0.3440	0.3427
3R	0.3366	0.3369	3S	0.3381	0.3762						
	0.3440	0.3428		0.3480	0.3840						
	0.3429	0.3307		0.3463	0.3687						
	0.3361	0.3245		0.3376	0.3616						
4A	0.3530	0.3597	4B	0.3548	0.3736	4C	0.3641	0.3804	4D	0.3615	0.3659
	0.3615	0.3659		0.3641	0.3804		0.3736	0.3874		0.3702	0.3722
	0.3590	0.3521		0.3615	0.3659		0.3702	0.3722		0.3670	0.3578
	0.3512	0.3465		0.3530	0.3597		0.3615	0.3659		0.3590	0.3521
5A1	0.3670	0.3578	5A2	0.3686	0.3649	5A3	0.3744	0.3685	5A4	0.3726	0.3612
	0.3686	0.3649		0.3702	0.3722		0.3763	0.3760		0.3744	0.3685
	0.3744	0.3685		0.3763	0.3760		0.3825	0.3798		0.3804	0.3721
	0.3726	0.3612		0.3744	0.3685		0.3804	0.3721		0.3783	0.3646

PERFORMANCE GROUPS - CHROMATICITY (CONTINUED)

Region	x	y	Region	x	y	Region	x	y	Region	x	y
5B1	0.3702	0.3722	5B2	0.3719	0.3797	5B3	0.3782	0.3837	5B4	0.3763	0.3760
	0.3719	0.3797		0.3736	0.3874		0.3802	0.3916		0.3782	0.3837
	0.3782	0.3837		0.3802	0.3916		0.3869	0.3958		0.3847	0.3877
	0.3763	0.3760		0.3782	0.3837		0.3847	0.3877		0.3825	0.3798
5C1	0.3825	0.3798	5C2	0.3847	0.3877	5C3	0.3912	0.3917	5C4	0.3887	0.3836
	0.3847	0.3877		0.3869	0.3958		0.3937	0.4001		0.3912	0.3917
	0.3912	0.3917		0.3937	0.4001		0.4006	0.4044		0.3978	0.3958
	0.3887	0.3836		0.3912	0.3917		0.3978	0.3958		0.3950	0.3875
5D1	0.3783	0.3646	5D2	0.3804	0.3721	5D3	0.3863	0.3758	5D4	0.3840	0.3681
	0.3804	0.3721		0.3825	0.3798		0.3887	0.3836		0.3863	0.3758
	0.3863	0.3758		0.3887	0.3836		0.3950	0.3875		0.3924	0.3794
	0.3840	0.3681		0.3863	0.3758		0.3924	0.3794		0.3898	0.3716
6A1	0.3889	0.3690	6A2	0.3915	0.3768	6A3	0.3981	0.3800	6A4	0.3953	0.3720
	0.3915	0.3768		0.3941	0.3848		0.4010	0.3882		0.3981	0.3800
	0.3981	0.3800		0.4010	0.3882		0.4080	0.3916		0.4048	0.3832
	0.3953	0.3720		0.3981	0.3800		0.4048	0.3832		0.4017	0.3751
6B1	0.3941	0.3848	6B2	0.3968	0.3930	6B3	0.4040	0.3966	6B4	0.4010	0.3882
	0.3968	0.3930		0.3996	0.4015		0.4071	0.4052		0.4040	0.3966
	0.4040	0.3966		0.4071	0.4052		0.4146	0.4089		0.4113	0.4001
	0.4010	0.3882		0.4040	0.3966		0.4113	0.4001		0.4080	0.3916
6C1	0.4080	0.3916	6C2	0.4113	0.4001	6C3	0.4186	0.4037	6C4	0.4150	0.3950
	0.4113	0.4001		0.4146	0.4089		0.4222	0.4127		0.4186	0.4037
	0.4186	0.4037		0.4222	0.4127		0.4299	0.4165		0.4259	0.4073
	0.4150	0.3950		0.4186	0.4037		0.4259	0.4073		0.4221	0.3984
6D1	0.4017	0.3751	6D2	0.4048	0.3832	6D3	0.4116	0.3865	6D4	0.4082	0.3782
	0.4048	0.3832		0.4080	0.3916		0.4150	0.3950		0.4116	0.3865
	0.4116	0.3865		0.4150	0.3950		0.4221	0.3984		0.4183	0.3898
	0.4082	0.3782		0.4116	0.3865		0.4183	0.3898		0.4147	0.3814
7A1	0.4147	0.3814	7A2	0.4183	0.3898	7A3	0.4242	0.3919	7A4	0.4203	0.3833
	0.4183	0.3898		0.4221	0.3984		0.4281	0.4006		0.4242	0.3919
	0.4242	0.3919		0.4281	0.4006		0.4342	0.4028		0.4300	0.3939
	0.4203	0.3833		0.4242	0.3919		0.4300	0.3939		0.4259	0.3853
7B1	0.4221	0.3984	7B2	0.4259	0.4073	7B3	0.4322	0.4096	7B4	0.4281	0.4006
	0.4259	0.4073		0.4299	0.4165		0.4364	0.4188		0.4322	0.4096
	0.4322	0.4096		0.4364	0.4188		0.4430	0.4212		0.4385	0.4119
	0.4281	0.4006		0.4322	0.4096		0.4385	0.4119		0.4342	0.4028
7C1	0.4342	0.4028	7C2	0.4385	0.4119	7C3	0.4449	0.4141	7C4	0.4403	0.4049
	0.4385	0.4119		0.4430	0.4212		0.4496	0.4236		0.4449	0.4141
	0.4449	0.4141		0.4496	0.4236		0.4562	0.4260		0.4513	0.4164
	0.4403	0.4049		0.4449	0.4141		0.4513	0.4164		0.4465	0.4071

PERFORMANCE GROUPS - CHROMATICITY (CONTINUED)

Region	x	y	Region	x	y	Region	x	y	Region	x	y
7D1	0.4259	0.3853	7D2	0.4300	0.3939	7D3	0.4359	0.3960	7D4	0.4316	0.3873
	0.4300	0.3939		0.4342	0.4028		0.4403	0.4049		0.4359	0.3960
	0.4359	0.3960		0.4403	0.4049		0.4465	0.4071		0.4418	0.3981
	0.4316	0.3873		0.4359	0.3960		0.4418	0.3981		0.4373	0.3893
8A1	0.4373	0.3893	8A2	0.4418	0.3981	8A3	0.4475	0.3994	8A4	0.4428	0.3906
	0.4418	0.3981		0.4465	0.4071		0.4523	0.4085		0.4475	0.3994
	0.4475	0.3994		0.4523	0.4085		0.4582	0.4099		0.4532	0.4008
	0.4428	0.3906		0.4475	0.3994		0.4532	0.4008		0.4483	0.3919
8B1	0.4465	0.4071	8B2	0.4513	0.4164	8B3	0.4573	0.4178	8B4	0.4523	0.4085
	0.4513	0.4164		0.4562	0.4260		0.4624	0.4274		0.4573	0.4178
	0.4573	0.4178		0.4624	0.4274		0.4687	0.4289		0.4634	0.4193
	0.4523	0.4085		0.4573	0.4178		0.4634	0.4193		0.4582	0.4099
8C1	0.4582	0.4099	8C2	0.4634	0.4193	8C3	0.4695	0.4207	8C4	0.4641	0.4112
	0.4634	0.4193		0.4687	0.4289		0.4750	0.4304		0.4695	0.4207
	0.4695	0.4207		0.4750	0.4304		0.4813	0.4319		0.4756	0.4221
	0.4641	0.4112		0.4695	0.4207		0.4756	0.4221		0.4700	0.4126
8D1	0.4483	0.3919	8D2	0.4532	0.4008	8D3	0.4589	0.4021	8D4	0.4538	0.3931
	0.4532	0.4008		0.4582	0.4099		0.4641	0.4112		0.4589	0.4021
	0.4589	0.4021		0.4641	0.4112		0.4700	0.4126		0.4646	0.4034
	0.4538	0.3931		0.4589	0.4021		0.4646	0.4034		0.4593	0.3944

PERFORMANCE GROUPS - DOMINANT WAVELENGTH

Color XLamp XP-C LEDs are tested for dominant wavelength (DWL) and sorted into one of the DWL bins defined below.

Color	DWL Group	Minimum DWL (nm) @ 350 mA	Maximum DWL (nm) @ 350 mA
Blue	B3	465	470
	B4	470	475
	B5	475	480
	B6	480	485
Green	G2	520	525
	G3	525	530
	G4	530	535
Amber	A2	585	590
	A3	590	595
Red-Orange	O3	610	615
	O4	615	620
Red	R2	620	625
	R3	625	630

PERFORMANCE GROUPS - FORWARD VOLTAGE

Amber, red-orange, and red XLamp XP-C LEDs are tested for forward voltage and sorted into one of the forward voltage bins defined below.

Forward Voltage Group	Minimum Forward Voltage (V) @ 350 mA	Maximum Forward Voltage (V) @ 350 mA
B	1.75	2.0
C	2.0	2.25
D	2.25	2.5
E	2.5	2.75
F	2.75	3.0
G	3.0	3.25
H	3.25	3.5
J	3.5	3.75

STANDARD COOL WHITE KITS PLOTTED ON ANSI STANDARD CHROMATICITY REGIONS

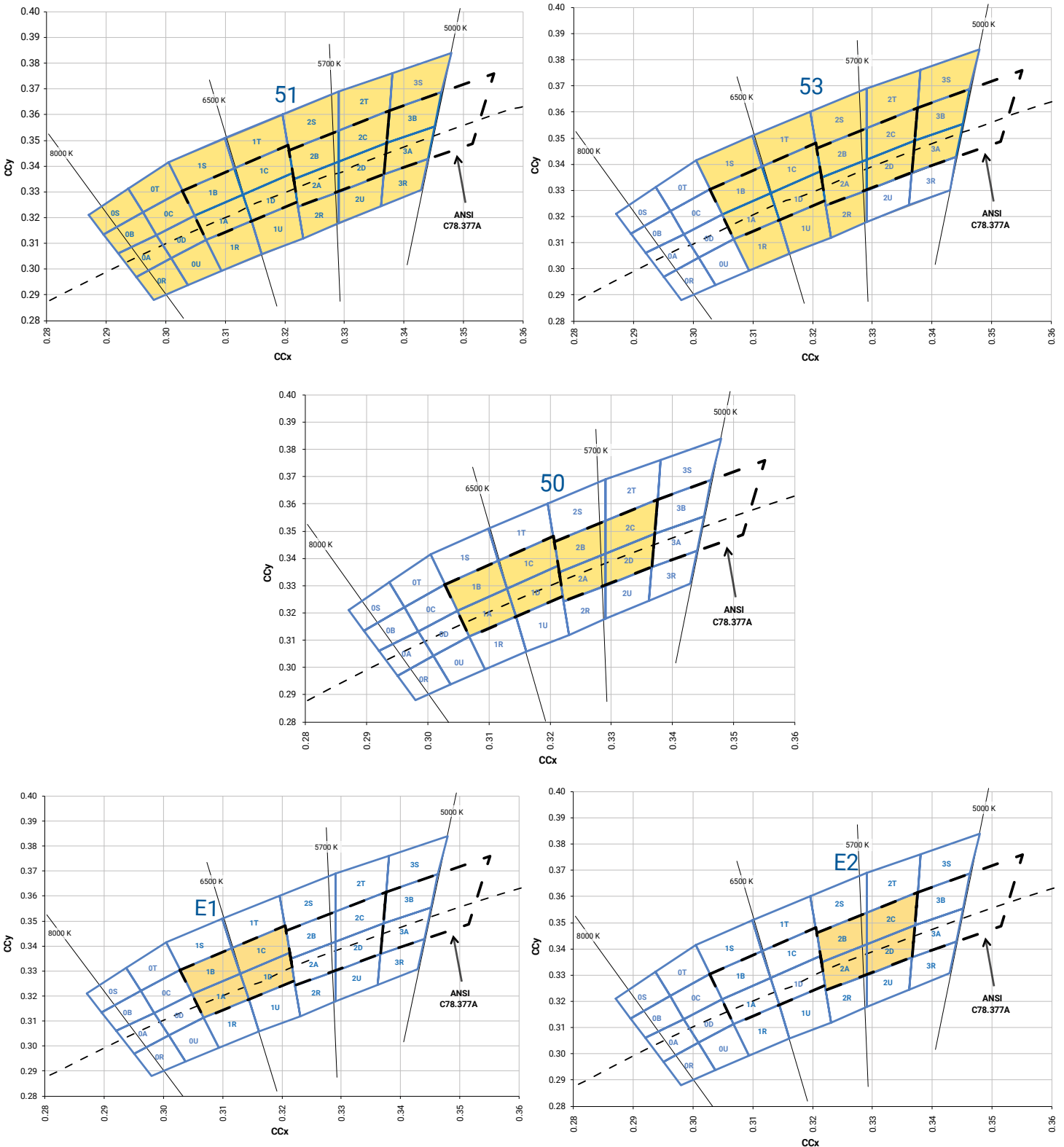

STANDARD WARM AND NEUTRAL WHITE KITS PLOTTED ON ANSI STANDARD CHROMATICITY REGIONS

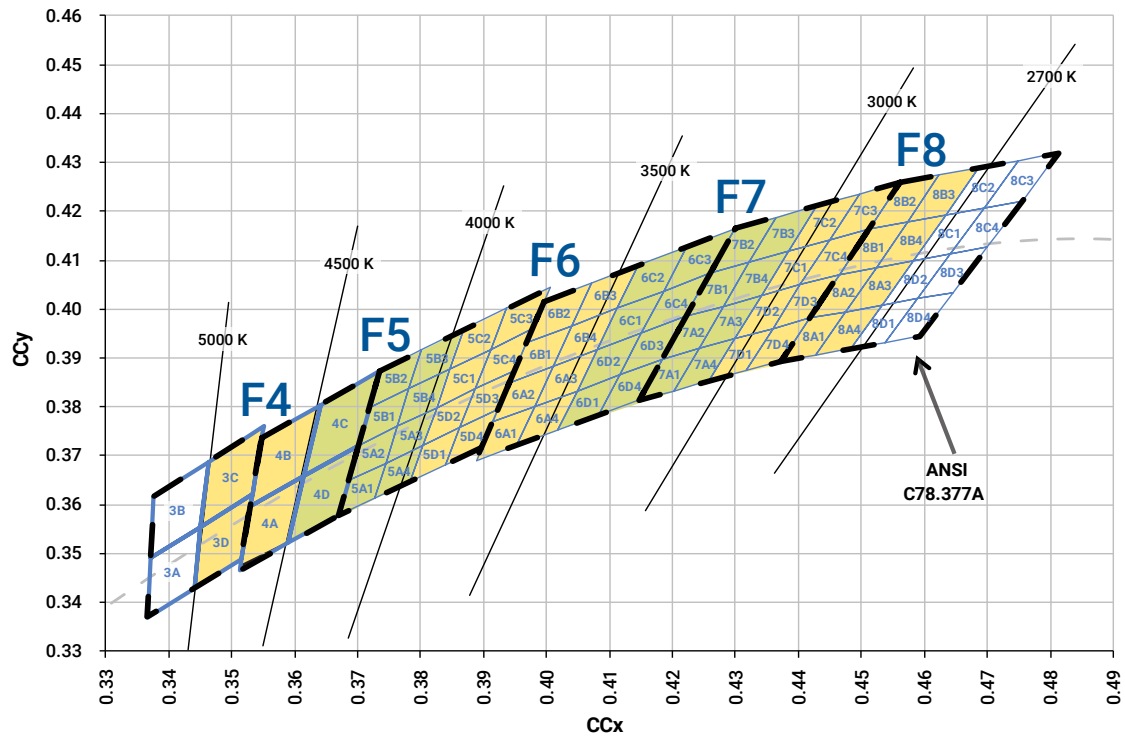
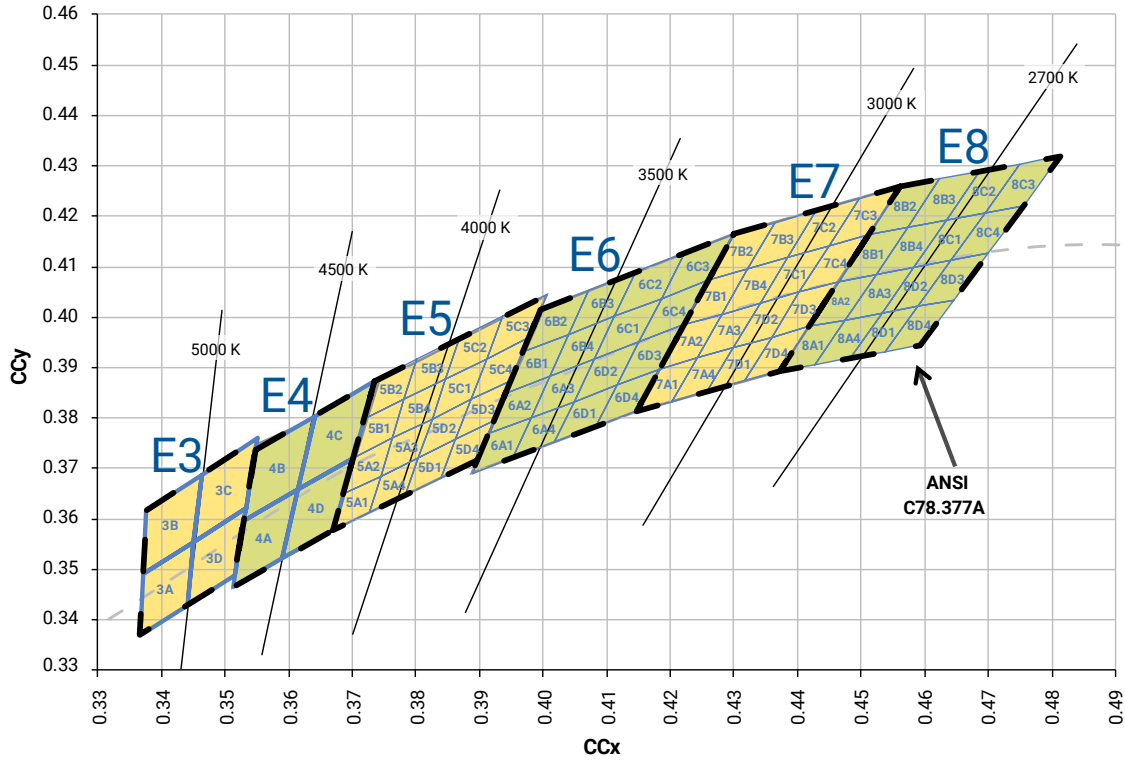

STANDARD CHROMATICITY KITS

The following table provides the chromaticity bins associated with chromaticity kits.

Color	CCT	Kit	Chromaticity Bins
Cool White	6200 K	51	0A, 0B, 0C, 0D, 0R, 0S, 0T, 0U, 1A, 1B, 1C, 1D, 1R, 1S, 1T, 1U, 2A, 2B, 2C, 2D, 2R, 2S, 2T, 2U, 3A, 3B, 3R, 3S
	6000 K	53	1A, 1B, 1C, 1D, 1R, 1S, 1T, 1U, 2A, 2B, 2C, 2D, 2R, 2S, 2T, 3A, 3B, 3S
	6200 K	50	1A, 1B, 1C, 1D, 2A, 2B, 2C, 2D
	6500 K	E1	1A, 1B, 1C, 1D
	5700 K	E2	2A, 2B, 2C, 2D
Neutral White	5000 K	E3	3A, 3B, 3C, 3D
	4750 K	F4	3C, 3D, 4A, 4B
	4500 K	E4	4A, 4B, 4C, 4D
	4250 K	F5	4C, 4D, 5A1, 5A2, 5A3, 5A4, 5B1, 5B2, 5B3, 5B4
	4000 K	E5	5A1, 5A2, 5A3, 5A4, 5B1, 5B2, 5B3, 5B4, 5C1, 5C2, 5C3, 5C4, 5D1, 5D2, 5D3, 5D4
Warm White	3750 K	F6	5C1, 5C2, 5C3, 5C4, 5D1, 5D2, 5D3, 5D4, 6A1, 6A2, 6A3, 6A4, 6B1, 6B2, 6B3, 6B4
	3500 K	E6	6A1, 6A2, 6A3, 6A4, 6B1, 6B2, 6B3, 6B4, 6C1, 6C2, 6C3, 6C4, 6D1, 6D2, 6D3, 6D4
	3250 K	F7	6C1, 6C2, 6C3, 6C4, 6D1, 6D2, 6D3, 6D4, 7A1, 7A2, 7A3, 7A4, 7B1, 7B2, 7B3, 7B4
	3000 K	E7	7A1, 7A2, 7A3, 7A4, 7B1, 7B2, 7B3, 7B4, 7C1, 7C2, 7C3, 7C4, 7D1, 7D2, 7D3, 7D4
	2850 K	F8	7C1, 7C2, 7C3, 7C4, 7D1, 7D2, 7D3, 7D4, 8A1, 8A2, 8A3, 8A4, 8B1, 8B2, 8B3, 8B4
	2700 K	E8	8A1, 8A2, 8A3, 8A4, 8B1, 8B2, 8B3, 8B4, 8C1, 8C2, 8C3, 8C4, 8D1, 8D2, 8D3, 8D4

BIN AND ORDER CODE FORMATS

XP-C bin codes and order codes are configured in the following manner:

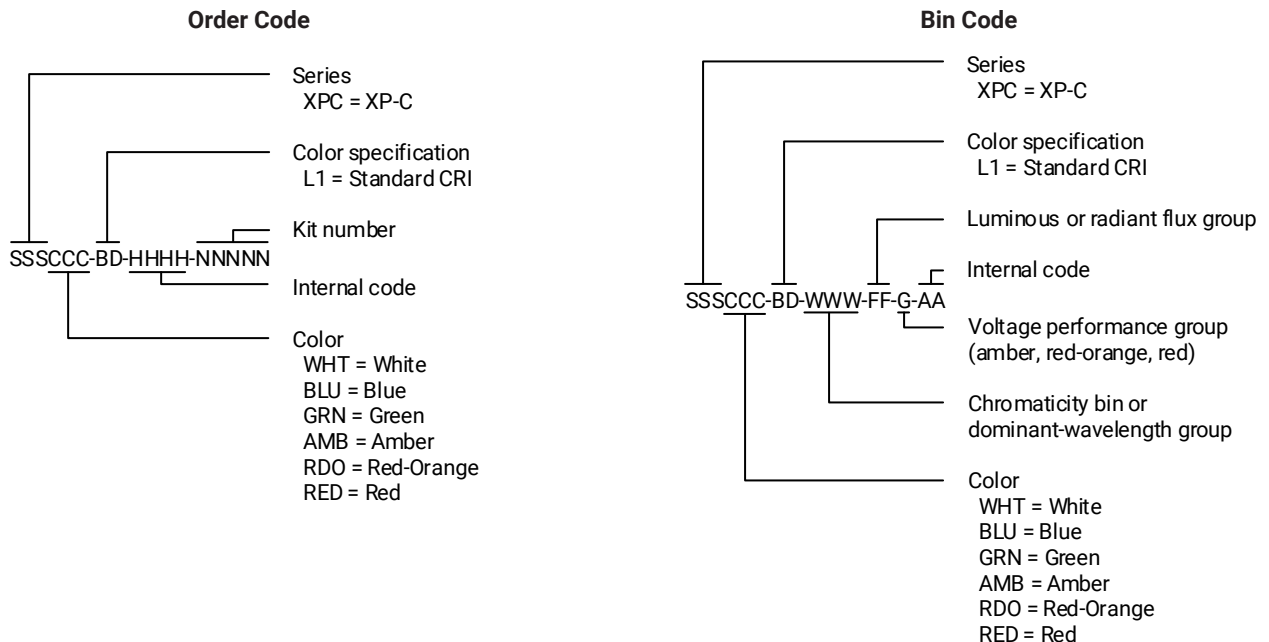

REFLOW SOLDERING CHARACTERISTICS

In testing, Cree LED has found XLamp XP-C LEDs to be compatible with JEDEC J-STD-020C, using the parameters listed below. As a general guideline, Cree LED recommends that users follow the recommended soldering profile provided by the manufacturer of the solder paste used, and therefore it is the lamp or luminaire manufacturer’s responsibility to determine applicable soldering requirements.

Note that this general guideline may not apply to all PCB designs and configurations of reflow soldering equipment.

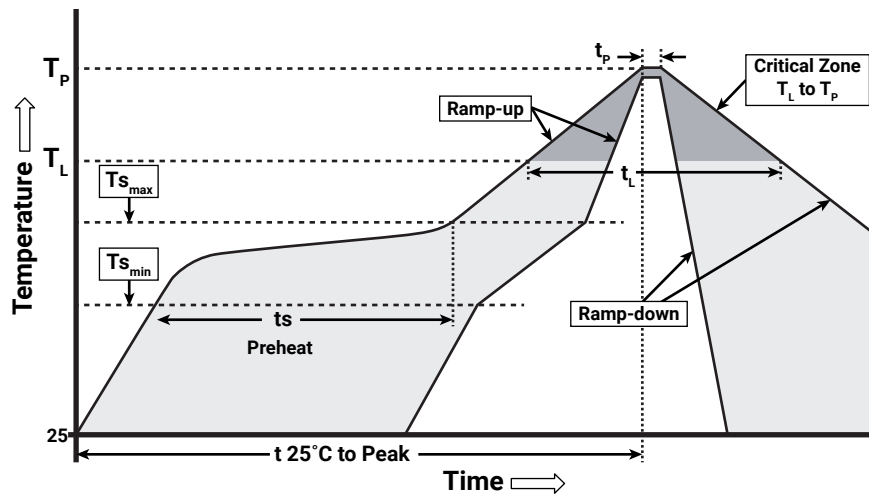

IPC/JEDEC J-STD-020C

Profile Feature	Lead-Free Solder
Average Ramp-Up Rate ($T_{s_{max}}$ to T_p)	1.2 °C/second
Preheat: Temperature Min ($T_{s_{min}}$)	120 °C
Preheat: Temperature Max ($T_{s_{max}}$)	170 °C
Preheat: Time ($t_{s_{min}}$ to $t_{s_{max}}$)	65-150 seconds
Time Maintained Above: Temperature (T_L)	217 °C
Time Maintained Above: Time (t_L)	45-90 seconds
Peak/Classification Temperature (T_p)	235 - 245 °C
Time Within 5 °C of Actual Peak Temperature (t_p)	20-40 seconds
Ramp-Down Rate	1 - 6 °C/second
Time 25 °C to Peak Temperature	4 minutes max.

Note: All temperatures refer to topside of the package, measured on the package body surface.

NOTES

Measurements

The luminous flux, radiant power, chromaticity, forward voltage and CRI measurements in this document are binning specifications only and solely represent product measurements as of the date of shipment. These measurements will change over time based on a number of factors that are not within Cree LED's control and are not intended or provided as operational specifications for the products. Calculated values are provided for informational purposes only and are not intended or provided as specifications.

Pre-Release Qualification Testing

Please read the [LED Reliability Overview](#) for details of the qualification process Cree LED applies to ensure long-term reliability for XLamp LEDs and details of Cree LED's pre-release qualification testing for XLamp LEDs.

Moisture Sensitivity

Cree LED recommends keeping XLamp LEDs in the provided, resealable moisture-barrier packaging (MBP) until immediately prior to soldering. Unopened MBPs that contain XLamp LEDs do not need special storage for moisture sensitivity.

Once the MBP is opened, XLamp XP-C LEDs may be stored as MSL 1 per JEDEC J-STD-033, meaning they have unlimited floor life in conditions of ≤ 30 °C/85% relative humidity (RH). Regardless of the storage condition, Cree LED recommends sealing any unsoldered LEDs in the original MBP.

RoHS Compliance

The levels of RoHS restricted materials in this product are below the maximum concentration values (also referred to as the threshold limits) permitted for such substances, or are used in an exempted application, in accordance with EU Directive 2011/65/EC (RoHS2), as implemented January 2, 2013. RoHS Declarations for this product can be obtained from your Cree LED representative or from the [Product Ecology](#) section of the Cree LED website.

REACH Compliance

REACH substances of very high concern (SVHCs) information is available for this product. Since the European Chemical Agency (ECHA) has published notice of their intent to frequently revise the SVHC listing for the foreseeable future, please contact a Cree LED representative to insure you get the most up-to-date REACH SVHC Declaration. REACH banned substance information (REACH Article 67) is also available upon request.

UL® Recognized Component

This product meets the requirements to be considered a UL Recognized Component with Level 4 enclosure consideration. The LED package or a portion thereof has been investigated as a fire and electrical enclosure per ANSI/UL 8750.

Vision Advisory

WARNING: Do not look at an exposed lamp in operation. Eye injury can result. For more information about LEDs and eye safety, please refer to the [LED Eye Safety application note](#).

NOTES - CONTINUED

Intellectual Property

For remote phosphor applications, a separate license to certain Cree LED patents is required.

MECHANICAL DIMENSIONS (T_A = 25 °C)

Thermal vias, if present, are not shown on these drawings.

All measurements are ±.13 mm unless otherwise indicated.

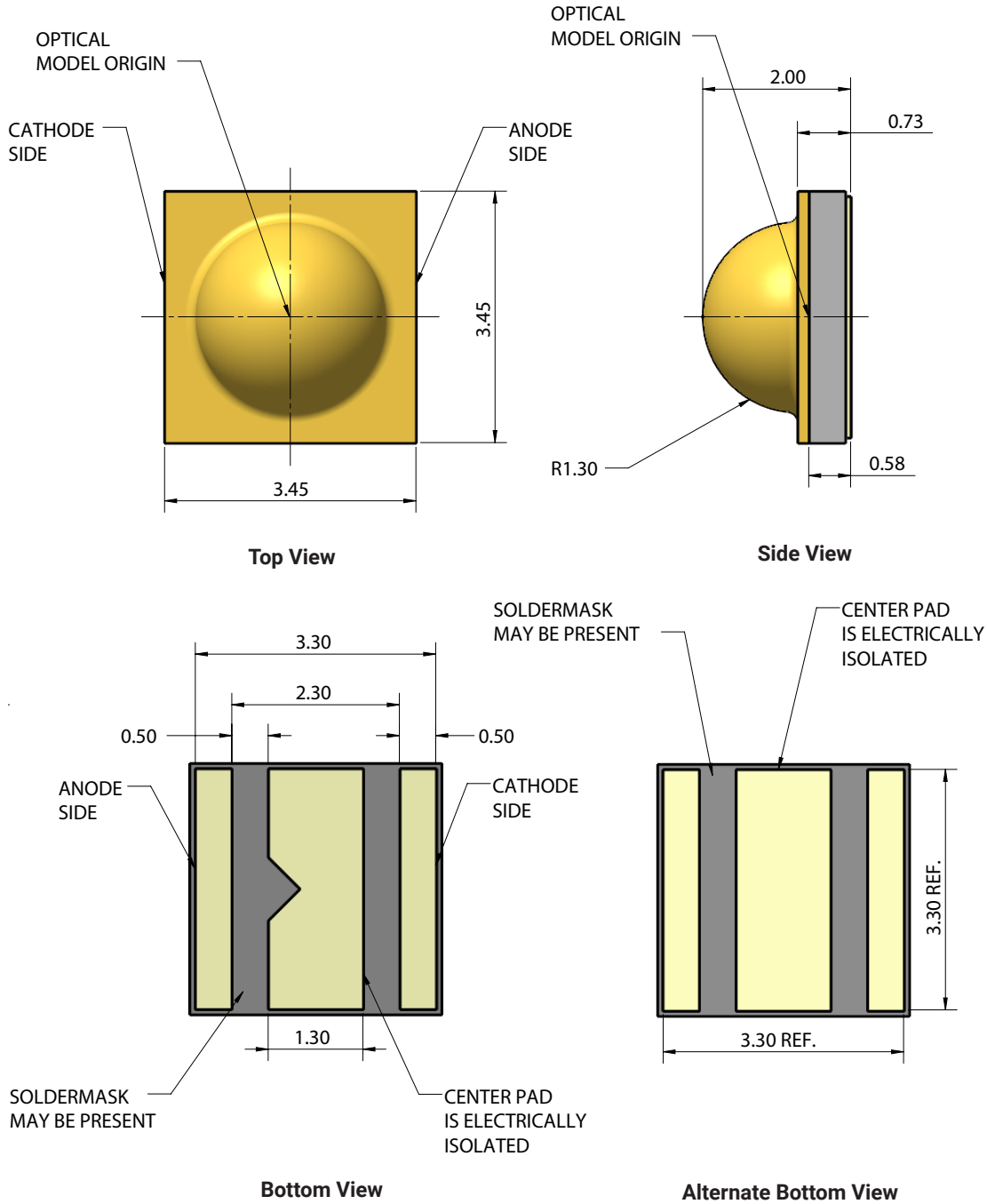

MECHANICAL DIMENSIONS - CONTINUED ($T_A = 25\text{ }^\circ\text{C}$)

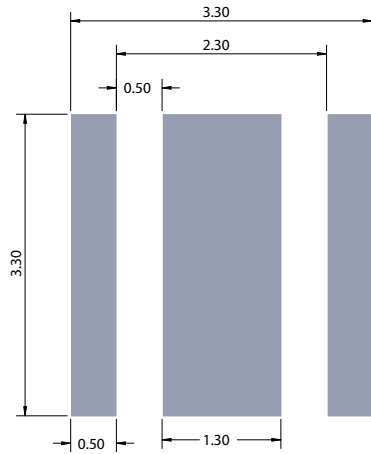

Recommended PCB Footprint

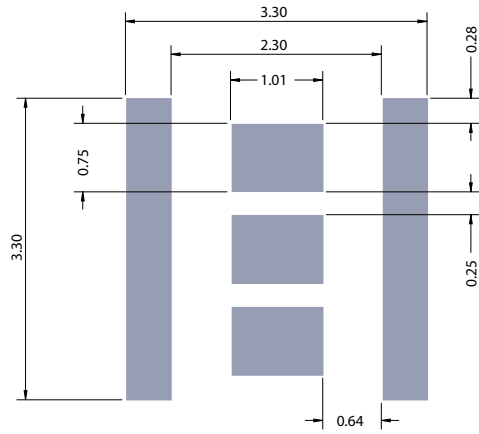

Recommended Stencil Opening

TAPE AND REEL

All Cree LED carrier tapes conform to EIA-481D, Automated Component Handling Systems Standard.

Except as noted, all dimensions in mm.

All measurements are ± 0.15 mm unless otherwise indicated.

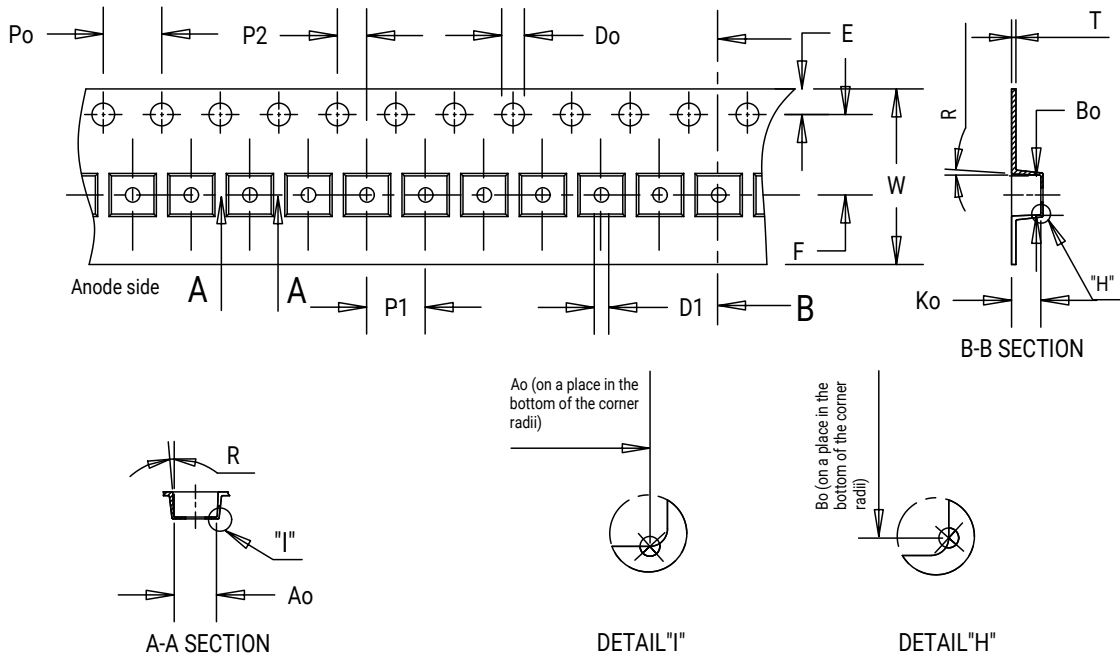

Item	Ao	Bo	Ko	Po	P1	P2	T	E	F	Do	D1	W	R
Dim.	3.75	3.75	2.10	4.00	8.00	2.00	0.30	1.75	5.50	1.50	1.50	12.00	8°

TAPE AND REEL - CONTINUED

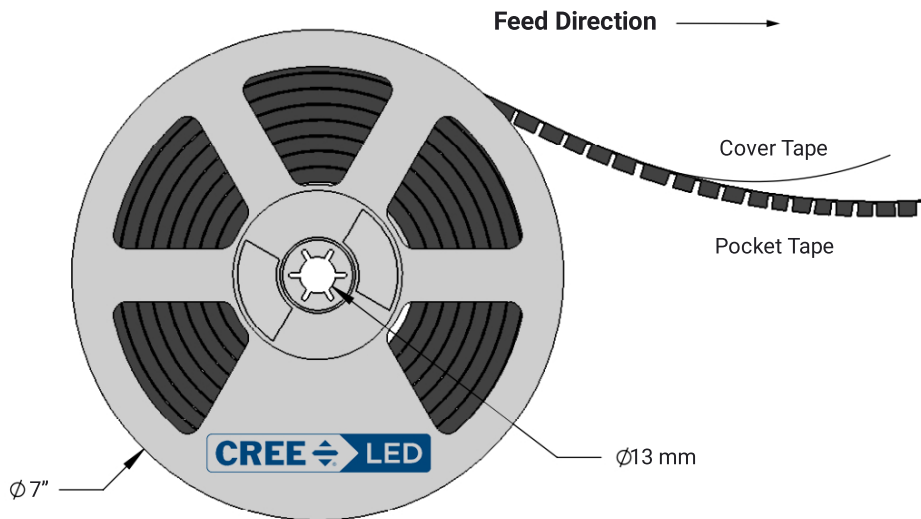
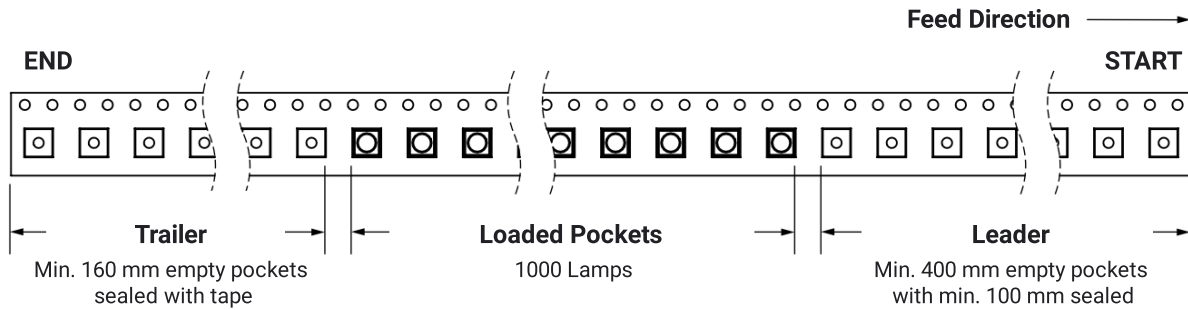

PACKAGING

Unpackaged Reel

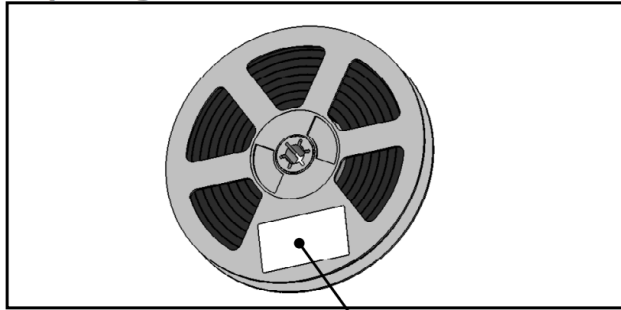

Label with Cree LED Bin Code, Quantity, Reel ID

Packaged Reel

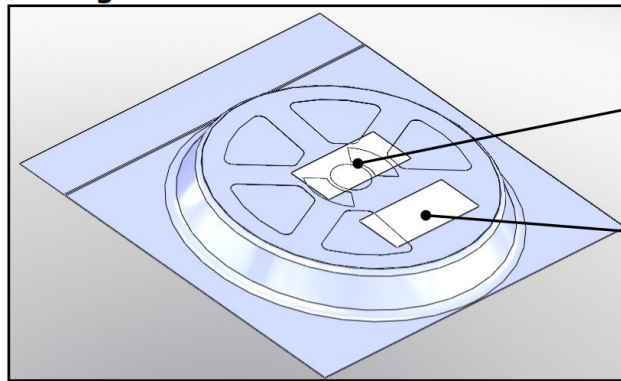

Label with Cree LED Order Code, Quantity, Reel ID, PO#

Label with Cree LED Bin Code, Quantity, Reel ID

Boxed Reel

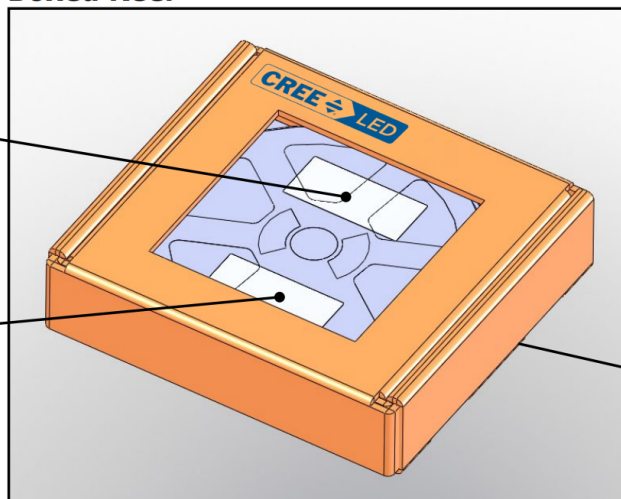

Label with Cree LED Order Code, Quantity, Reel ID, PO#

Label with Cree LED Bin Code, Quantity, Reel ID

Patent Label (on bottom of box)

APPENDIX - ORDER CODES NOT FOR NEW DESIGNS

The following order codes are active and valid order codes, but higher performance options are also available. Please see page 3 for order codes of XLamp XP-C LEDs that could serve as alternatives for the order codes set forth below.

Minimum Luminous Flux (lm) @ 350 mA		Chromaticity Regions	Order Codes
Group	Flux (lm)		
Q2	87.4	WA, WB, WC, WD, WE, WF, WG, WH, WJ, WK, WM, WN, WP	XPCWHT-L1-0000-00A01
		WC, WD, WF, WG	XPCWHT-L1-0000-00A02
		WC, WD, WF, WG, WH, WJ, WN, WP	XPCWHT-L1-0000-00A03
Q3	93.9	WA, WB, WC, WD, WE, WF, WG, WH, WJ, WK, WM, WN, WP	XPCWHT-L1-0000-00B01
		WC, WD, WF, WG	XPCWHT-L1-0000-00B02
		WC, WD, WF, WG, WH, WJ, WN, WP	XPCWHT-L1-0000-00B03
Q4	100	WA, WB, WC, WD, WE, WF, WG, WH, WJ, WK, WM, WN, WP	XPCWHT-L1-0000-00C01
		WC, WD, WF, WG	XPCWHT-L1-0000-00C02
		WC, WD, WF, WG, WH, WJ, WN, WP	XPCWHT-L1-0000-00C03
Q5	107	WA, WB, WC, WD, WE, WF, WG, WH, WJ, WK, WM, WN, WP	XPCWHT-L1-0000-00D01
		WC, WD, WF, WG	XPCWHT-L1-0000-00D02
		WC, WD, WF, WG, WH, WJ, WN, WP	XPCWHT-L1-0000-00D03
R4	130	WA, WB, WC, WD, WE, WF, WG, WH, WJ, WK, WM, WN, WP	XPCWHT-L1-0000-00G01
		WC, WD, WF, WG	XPCWHT-L1-0000-00G02

Notes:

- Cree LED maintains a tolerance of $\pm 7\%$ on flux and power measurements, ± 0.005 on chromaticity (CCx, CCy) measurements and a tolerance of ± 2 on CRI measurements. See the Measurements section (page 27).
- XLamp XP-C LED order codes specify only a minimum flux bin and not a maximum. Cree LED may ship reels in flux bins higher than the minimum specified by the order code without advance notice. Shipments will always adhere to the chromaticity bin restrictions specified by the order code.

APPENDIX - ORDER CODES NOT FOR NEW DESIGNS - CONTINUED

The following order codes are active and valid order codes, but higher performance options are also available. Please see page 4 - page 5 for order codes of XLamp XP-C LEDs that could serve as alternatives for the order codes set forth below.

Chromaticity		Minimum Luminous Flux (lm) @ 350 mA		Order Codes
Kit	CCT	Code	Flux (lm)	70 CRI Typical
51	6200 K	R4	130	XPCWHT-L1-0000-00G51
53	6000 K	R4	130	XPCWHT-L1-0000-00G53
50	6200 K	R4	130	XPCWHT-L1-0000-00G50
E1	6500 K	R4	130	XPCWHT-L1-0000-00GE1
E2	5700 K	R4	130	XPCWHT-L1-0000-00GE2
E3	5000 K	R4	130	XPCWHT-L1-0000-00GE3
		R3	122	XPCWHT-L1-0000-00FE3
F4	4750 K	R4	130	XPCWHT-L1-0000-00GF4
		R3	122	XPCWHT-L1-0000-00FF4
E4	4500 K	R4	130	XPCWHT-L1-0000-00GE4
		R3	122	XPCWHT-L1-0000-00FE4
F5	4250 K	R3	122	XPCWHT-L1-0000-00FF5
		R2	114	XPCWHT-L1-0000-00EF5
E5	4000 K	R3	122	XPCWHT-L1-0000-00FE5
		R2	114	XPCWHT-L1-0000-00EE5
F6	3750 K	R3	122	XPCWHT-L1-0000-00FF6
		R2	114	XPCWHT-L1-0000-00EF6
E6	3500 K	R3	122	XPCWHT-L1-0000-00FE6
		R2	114	XPCWHT-L1-0000-00EE6
F7	3250 K	R2	114	XPCWHT-L1-0000-00EF7
		Q5	107	XPCWHT-L1-0000-00DF7
E7	3000 K	R2	114	XPCWHT-L1-0000-00EE7
		Q5	107	XPCWHT-L1-0000-00DE7
F8	2850 K	R2	114	XPCWHT-L1-0000-00EF8
		Q5	107	XPCWHT-L1-0000-00DF8
E8	2700 K	R2	114	XPCWHT-L1-0000-00EE8
		Q5	107	XPCWHT-L1-0000-00DE8

Notes:

- Cree LED maintains a tolerance of $\pm 7\%$ on flux and power measurements, ± 0.005 on chromaticity (CCx, CCy) measurements and a tolerance of ± 2 on CRI measurements. See the Measurements section (page 27).
- XLamp XP-C LED order codes specify only a minimum flux bin and not a maximum. Cree LED may ship reels in flux bins higher than the minimum specified by the order code without advance notice. Shipments will always adhere to the chromaticity bin restrictions specified by the order code.

APPENDIX - ORDER CODES NOT FOR NEW DESIGNS - CONTINUED

The following order codes are active and valid order codes, but higher performance options are also available. Please see page 6 for order codes of XLamp XP-C LEDs that could serve as alternatives for the order codes set forth below.

Color	Minimum Luminous Flux (@ 350 mA)		Dominant Wavelength (nm)				Order Codes
			Minimum		Maximum		
	Group	Flux (lm)	Group	DWL (nm)	Group	DWL (nm)	
Blue	J	23.5	B3	465	B6	485	XPCBLU-L1-0000-00W01
			B3	465	B5	480	XPCBLU-L1-0000-00W02
			B4	470	B5	480	XPCBLU-L1-0000-00W05
	K2	30.6	B3	465	B6	485	XPCBLU-L1-0000-00Y01
			B3	465	B5	480	XPCBLU-L1-0000-00Y02
			B4	470	B5	480	XPCBLU-L1-0000-00Y05

Color	Minimum Luminous Flux (@ 350 mA)		Dominant Wavelength (nm)				Order Codes
			Minimum		Maximum		
	Group	Flux (lm)	Group	DWL (nm)	Group	DWL (nm)	
Green	N3	56.8	G2	520	G4	535	XPCGRN-L1-0000-00501
			G2	520	G3	530	XPCGRN-L1-0000-00502
			G3	525	G4	535	XPCGRN-L1-0000-00503
	N4	62.0	G2	520	G4	535	XPCGRN-L1-0000-00601
			G2	520	G3	530	XPCGRN-L1-0000-00602
			G3	525	G4	535	XPCGRN-L1-0000-00603
	P2	67.2	G2	520	G4	535	XPCGRN-L1-0000-00701
			G2	520	G3	530	XPCGRN-L1-0000-00702
			G3	525	G4	535	XPCGRN-L1-0000-00703
	P3	73.9	G2	520	G4	535	XPCGRN-L1-0000-00801
			G2	520	G3	530	XPCGRN-L1-0000-00802
			G3	525	G4	535	XPCGRN-L1-0000-00803
	P4	80.6	G2	520	G4	535	XPCGRN-L1-0000-00901
			G2	520	G3	530	XPCGRN-L1-0000-00902
			G3	525	G4	535	XPCGRN-L1-0000-00903

Notes:

- Cree LED maintains a tolerance of ±7% on flux and power measurements, ±0.005 on chromaticity (CCx, CCy) measurements and a tolerance of ±2 on CRI measurements. See the Measurements section (page 27).
- XLamp XP-C LED order codes specify only a minimum flux bin and not a maximum. Cree LED may ship reels in flux bins higher than the minimum specified by the order code without advance notice. Shipments will always adhere to the chromaticity bin restrictions specified by the order code.

APPENDIX - ORDER CODES NOT FOR NEW DESIGNS - CONTINUED

The following order codes are active and valid order codes, but higher performance options are also available. Please see page 7 and page 8 for order codes of XLamp XP-C LEDs that could serve as alternatives for the order codes set forth below.

Color	Minimum Luminous Flux (@ 350 mA)		Dominant Wavelength (nm)				Order Codes
			Minimum		Maximum		
	Group	Flux (lm)	Group	DWL (nm)	Group	DWL (nm)	
Red-Orange	N2	51.7	03	610	04	620	XPCRDO-L1-0000-00401
			03	610	03	615	XPCRDO-L1-0000-00402
			04	615	04	620	XPCRDO-L1-0000-00403
	N3	56.8	03	610	04	620	XPCRDO-L1-0000-00501
			03	610	03	615	XPCRDO-L1-0000-00502
			04	615	04	620	XPCRDO-L1-0000-00503
	N4	62.0	03	610	04	620	XPCRDO-L1-0000-00601
			03	610	03	615	XPCRDO-L1-0000-00602
			04	615	04	620	XPCRDO-L1-0000-00603
	P2	67.2	03	610	04	620	XPCRDO-L1-0000-00701
			03	610	03	615	XPCRDO-L1-0000-00702
			04	615	04	620	XPCRDO-L1-0000-00703

Color	Minimum Luminous Flux (@ 350 mA)		Calculated Minimum Luminous Flux @ 125 mA*	Dominant Wavelength (nm)				Order Codes
				Minimum		Maximum		
	Group	Flux (lm)	Flux (lm)	Group	DWL (nm)	Group	DWL (nm)	
Red	M2	39.8	15.2	R2	620	R3	630	XPCRED-L1-0000-00201
				R2	620	R2	625	XPCRED-L1-0000-00202
	M3	45.7	17.5	R2	620	R3	630	XPCRED-L1-0000-00301
				R2	620	R2	625	XPCRED-L1-0000-00302
	N2	51.7	19.7	R2	620	R3	630	XPCRED-L1-0000-00401
				R2	620	R2	625	XPCRED-L1-0000-00402
	N3	56.8	21.7	R2	620	R3	630	XPCRED-L1-0000-00501
				R2	620	R2	625	XPCRED-L1-0000-00502

Notes:

- Cree LED maintains a tolerance of ±7% on flux and power measurements, ±0.005 on chromaticity (CCx, CCy) measurements and a tolerance of ±2 on CRI measurements. See the Measurements section (page 27).
- XLamp XP-C LED order codes specify only a minimum flux bin and not a maximum. Cree LED may ship reels in flux bins higher than the minimum specified by the order code without advance notice. Shipments will always adhere to the chromaticity bin restrictions specified by the order code.