

U2J with KONNEKT™ Technology for High-Efficiency, High-Density Power Applications (Commercial Grade)



Overview

KEMET's U2J with KONNEKT™ Technology surface mount capacitors are designed for high-efficiency and high-density power applications. KONNEKT utilizes an innovative Transient Liquid Phase Sintering (TLPS) material to create a leadless multi-chip solution. When combined with KEMET's ultra-stable U2J dielectric, KONNEKT enables a low-loss, low-inductance package capable of handling extremely high ripple currents in the hundreds of kilohertz.

U2J is an extremely stable Class I dielectric material that exhibits a negligible shift in capacitance with respect to

voltage and a predictable and linear change in capacitance with reference to ambient temperature, with minimal aging effect. Capacitance change is limited to -750 ± 120 ppm/°C from -55°C to $+125^{\circ}\text{C}$.

U2J with KONNEKT™ Technology can also be mounted in a low-loss orientation to further increasing its power handling capability. The low-loss orientation lowers ESR (Effective Series Resistance) and ESL (Effective Series Inductance) which increases ripple current handling capability.

Benefits

- Extremely high-power density and ripple current capability
- Extremely low equivalent series resistance (ESR)
- Extremely low equivalent series inductance (ESL)
- Operating temperature range of -55°C to $+125^{\circ}\text{C}$
- Retains over 99% of nominal capacitance at full rated voltage
- Low noise
- Surface mountable using standard MLCC reflow profiles
- Low-loss orientation option for higher current handling capability
- RoHS compliant and Pb-free

Applications

- Wide bandgap (WBG), silicon carbide (SiC) and gallium nitride (GaN) systems
- Data centers
- LLC resonant converters
- Switched tank converters
- Wireless charging systems
- Photovoltaic systems
- Power converters
- Inverters
- DC link
- Snubber

Standard



Low Loss

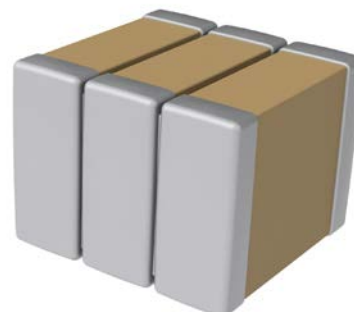

Typical Performance

Part Type	Mounting Configuration	Typical ESR at 25°C, 100 kHz	Typical ESL at 25°C	Typical Ripple Current (A_{rms}) ¹		
				100 kHz	200 kHz	300 kHz
1812 940 nF	Standard	1.15 mΩ	1.1 nH	12.0	12.0	11.5
	Low Loss	0.77 mΩ	0.45 nH	18.0	18.0	16.0
1812 1.4 μF	Standard	1.3 mΩ	1.6 nH	11.0	10.0	10.0
	Low Loss	0.35 mΩ	0.4 nH	20.0	34.0	31.0

¹ Ripple current measurements performed at 85°C with a peak capacitor temperature of 95°C. Samples mounted to heat sink with no forced air cooling. Maximum ambient and self heating cannot exceed 125°C.

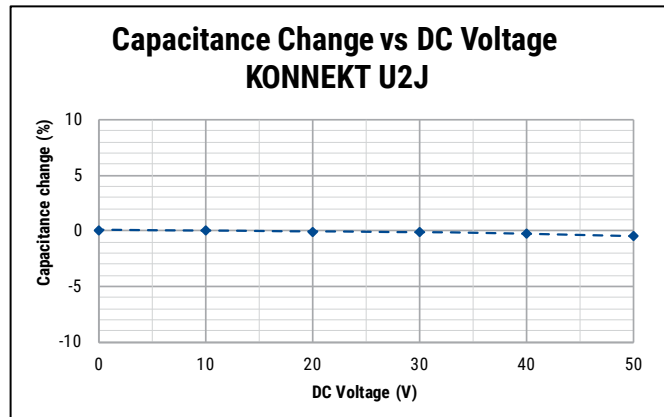
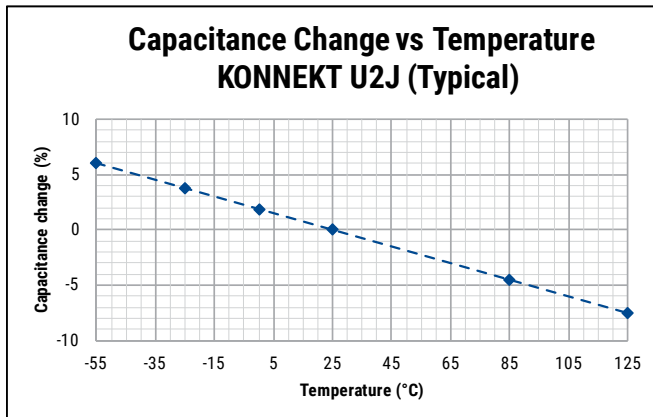
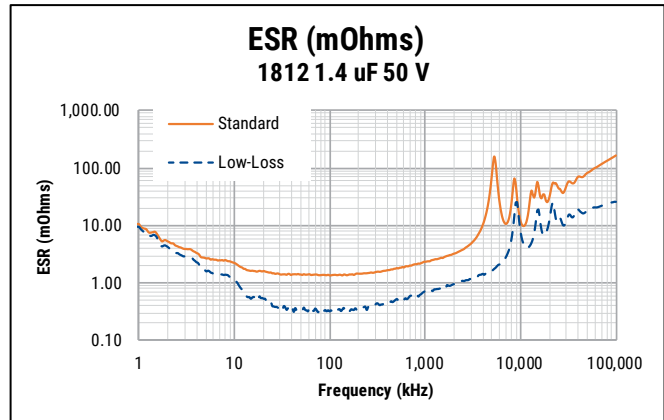
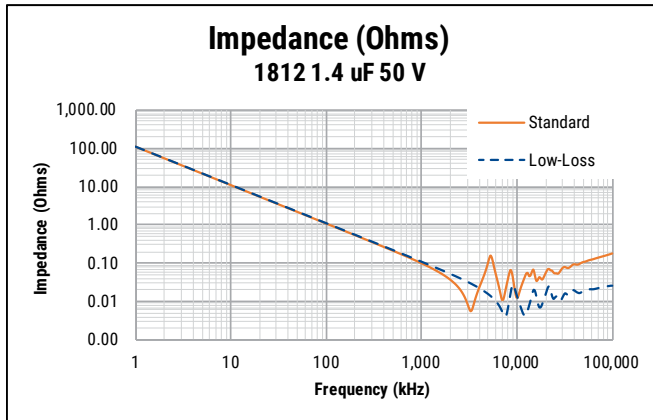
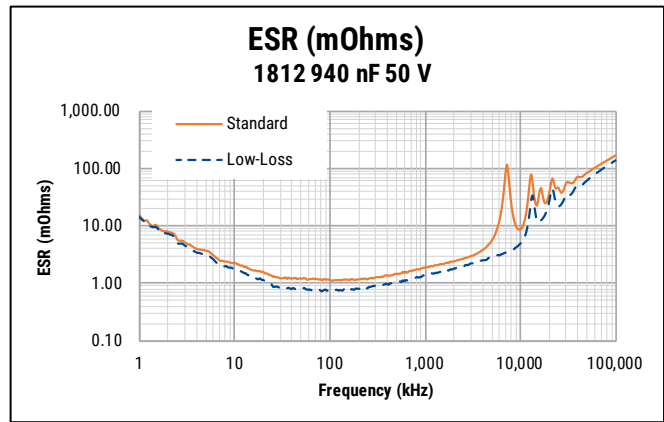
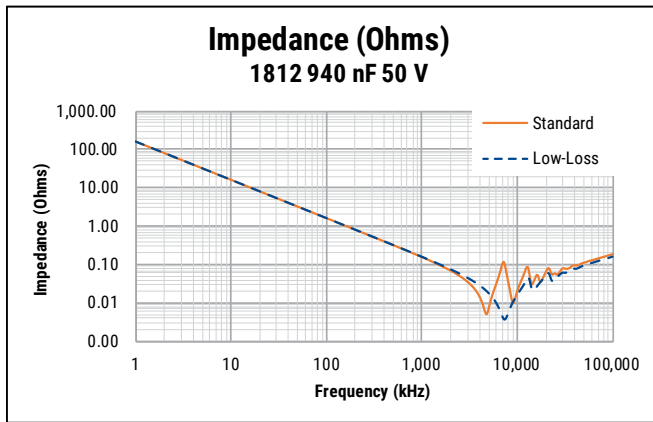

Typical Performance cont.

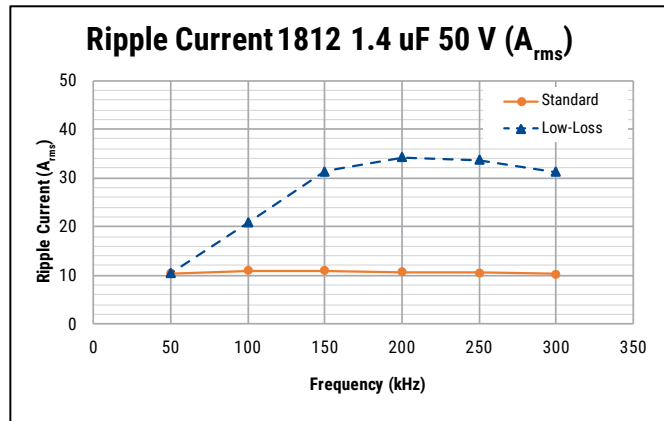
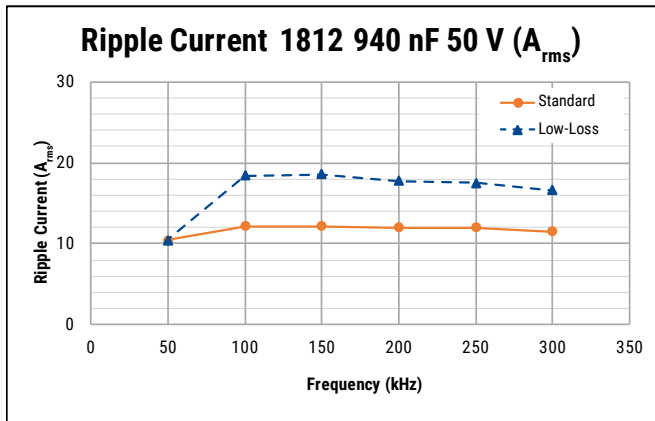

Ordering Information

C	1812	C	145	J	5	J	L	C	7XXX
Series	Case Size (L"x W")	Specification/ Series	Capacitance Code (pF)	Capacitance Tolerance	Rated Voltage (V)	Dielectric	Subclass Designation	Termination Finish	Packaging (Suffix/C-Spec)
C = Ceramic	1812	C = Standard	Two single digits and number of zeros.	J = ±5% K = ±10%	5 = 50 V	J = U2J	L = KONNEKT	C = 100% matte Sn	See "Packaging C-Spec Ordering Options Table"

See Table 1A for available capacitance and voltage ratings.

Table 1A - Product Ordering Codes, Ratings, and Package Quantities

KEMET Part Number ¹	Capacitance	Cap Code	Voltage	Number of Chips	Orientation	Thickness mm (inch)	Typical Average Piece Weight (g)	Tape & Reel Quantity	
								7" Tape & Reel	13" Tape & Reel
C1812C944(a)5RLC(b)	940 nF	944	50 V	2	Standard	3.5 (0.137) ±0.40 (0.016)	0.22	500	2,000
					Low Loss	3.20 (0.126) ±0.30 (0.012)		500	2,200
C1812C145(a)5RLC(b)	1.4 µF	145	50 V	3	Standard	5.3 (0.208) ±0.60 (0.024)	0.33	200	900
					Low Loss	3.20 (0.126) ±0.30 (0.012)		500	2,200



¹ Complete part number requires additional characters in the numbered positions provided in order to indicate capacitance tolerance and grade.

For each numbered position, available options are as follows:

(a) Capacitance tolerance character "J" or "K"

(b) See Table 1B for C-Spec options

Table 1B - Packaging C-Spec Ordering Options Table

Mounting Orientation		Packaging Type	Packaging/Grade Ordering Code (C-Spec)
Standard		7" Reel/Unmarked	TU
		13" Reel/Unmarked	7210
Low Loss		7" Reel/Unmarked	7805
		13" Reel/Unmarked	7810

Dimensions – Millimeters (Inches)

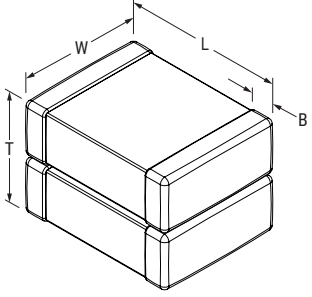
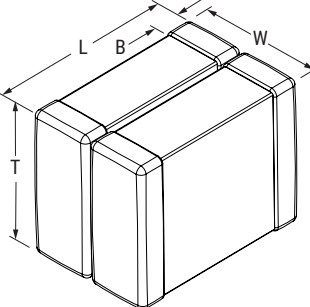
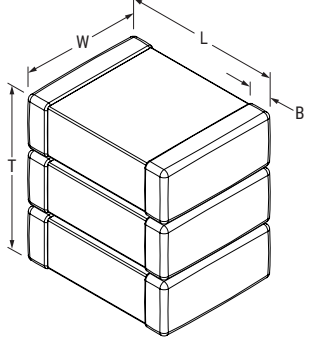
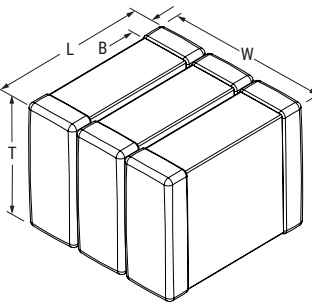
Standard Mounting 2 Chips	Low Loss Mounting 2 Chips	Standard Mounting 3 Chips	Low Loss Mounting 3 Chips
			

Number of Chips	Mounting	EIA SIZE CODE	METRIC SIZE CODE	L LENGTH	W WIDTH	T THICKNESS	B BANDWIDTH	Mounting Technique
2	Standard	1812	4532	4.50 (0.177) ±0.30 (0.012)	3.2 (0.126) ±0.3 (0.012)	3.5 (0.137) ±0.4 (0.016)	0.6 (0.024) ±0.35 (0.014)	Solder Reflow Only
	Low Loss				3.5 (0.137) ±0.4 (0.016)	3.2 (0.126) ±0.3 (0.012)		
3	Standard				3.2 (0.126) ±0.3 (0.012)	5.3 (0.208) ±0.6 (0.024)		
	Low Loss				5.3 (0.208) ±0.6 (0.024)	3.2 (0.126) ±0.3 (0.012)		

Table 2 - Performance and Reliability: Test Methods and Conditions

Test	Reference	Test Condition	Limits										
Visual and Mechanical	KEMET Internal	No defects that may affect performance (10X)	Dimensions according KEMET Spec Sheet										
Capacitance (Cap)	KEMET Internal	1 kHz ±50 Hz and 1.0 ±0.2 V _{rms} Capacitance measurements (including tolerance) are indexed to a referee time of 1,000 hours	Within Tolerance										
Dissipation Factor (DF)	KEMET Internal	1 kHz ±50 Hz and 1.0 ±0.2 V _{rms}	Dissipation factor (DF) maximum limit at 25°C = 0.1%										
Insulation Resistance (IR)	KEMET Internal	Apply rated voltage for 120 seconds at 25°C	Within Specification To obtain IR limit, divide MΩ-μF value by the capacitance and compare to GΩ limit. Select the lower of the two limits. 1,000 MΩ-μF or 100 GΩ										
Temperature Coefficient of Capacitance (TCC)	KEMET Internal	Frequency: 1 kHz ±50 Hz Capacitance Change with Reference to +25°C and 0 VDC Applied * See part number specification sheet for voltage <table border="1" style="margin-left: auto; margin-right: auto;"> <thead> <tr> <th>Step</th> <th>Temperature (°C)</th> </tr> </thead> <tbody> <tr> <td>1</td> <td>+25°C</td> </tr> <tr> <td>2</td> <td>-55°C</td> </tr> <tr> <td>3</td> <td>+25°C (Reference Temperature)</td> </tr> <tr> <td>4</td> <td>+125°C</td> </tr> </tbody> </table>	Step	Temperature (°C)	1	+25°C	2	-55°C	3	+25°C (Reference Temperature)	4	+125°C	-750 ±120 ppm/°C
Step	Temperature (°C)												
1	+25°C												
2	-55°C												
3	+25°C (Reference Temperature)												
4	+125°C												
Dielectric Withstanding Voltage (DWV)	KEMET Internal	250% of rated voltage (5 ±1 seconds and charge/discharge not exceeding 50 mA)	Cap: Initial Limit DF: Initial Limit IR: Initial Limit Withstand test voltage without insulation breakdown or damage.										
Aging Rate (Maximum % Capacitance Loss/Decade Hour)	KEMET Internal	Capacitance measurements (including tolerance) are indexed to a referee time of 1,000 hours. Please refer to a part number specific datasheet for referee time details.	0.1% Loss/Decade Hour										
Terminal Strength	KEMET Internal	Shear stress test per specific case size, Time: 60±1 seconds <table border="1" style="margin-left: auto; margin-right: auto;"> <thead> <tr> <th>Case Size</th> <th>Force</th> </tr> </thead> <tbody> <tr> <td>1812</td> <td>18N</td> </tr> </tbody> </table> 	Case Size	Force	1812	18N	No evidence of mechanical damage						
Case Size	Force												
1812	18N												

Table 2 - Performance and Reliability: Test Methods and Conditions cont.

Test	Reference	Test Condition	Limits
Board Flex	AEC-Q200-005	Standard Termination system 2.0 mm Test time: 60± 5 seconds Ramp time: 1 mm/second  (Unit : mm)	No evidence of mechanical damage
Solderability	KEMET Custom Test	1. Board shear – SAC305 solder. Shear force of 1.8 kg (minimum) 2. Wetting balance – IEC 60068-2-69	Visual Inspection. 95% coverage on termination. No leaching.
Temperature Cycling	JESD22 Method JA-104	1,000 cycles (-55°C to +125°C) 2-3 cycles per hour Soak Time 1 or 5 minute	Measurement at 24 hours ±4 hours after test conclusion. Cap: Initial Limit DF: Initial Limit IR: Initial Limit
Biased Humidity	MIL-STD-202 Method 103	Load Humidity: 1,000 hours 85°C / 85% RH and rated voltage, or 200 VDC maximum. Low Volt Humidity: 1,000 hours 85°C/85% RH and 1.5 V.	Measurement at 24 hours ±4 hours after test conclusion. Within Post Environmental Limits: Cap: ±0.3% or ±0.25pF shift IR: 10% of Initial Limit DF Limits Maximum: 0.5%
Moisture Resistance	MIL-STD-202 Method 106	Number of cycles required 10, 24 hours per cycle. Steps 7a and 7b not required	Measurement at 24 hours ±4 hours after test conclusion. Within Post Environmental Limits Cap: ±0.3% or ±0.25pF shift IR: 10% of Initial Limit DF Limits Maximum: 0.5%
Thermal Shock	MIL-STD-202 Method 107	Number of cycles required 5, (-55°C to 125°C) Dwell time 15 minutes.	Cap: Initial Limit DF: Initial Limit IR: Initial Limit

Table 2 - Performance and Reliability: Test Methods and Conditions cont.

Test	Reference	Test Condition	Limits
High Temperature Life	MIL-STD-202 Method 108	1,000 hours at 125°C with 1.0 X rated voltage applied.	Within Post Environmental Limits Cap: ±0.3% or ±0.25pF shift IR: 10% of Initial Limit DF Limits Maximum: 0.5%
Storage Life		1,000 hours at 125°C, Unpowered	
Vibration	MIL-STD-202 Method 204	5 G's for 20 minutes, 12 cycles each of 3 orientations. Test from 10 – 2,000 Hz	Cap: Initial Limit DF: Initial Limit IR: Initial Limit
Mechanical Shock	MIL-STD-202 Method 213	1,500 G's 0.5ms Half-sine, Velocity Change: 15.4 feet/second (Condition F)	Cap: Initial Limit DF: Initial Limit IR: Initial Limit
Resistance to Solvents	MIL-STD-202 Method 215	Add Aqueous wash chemical OKEMCLEAN (A 6% concentrated Oakite cleaner) or equivalent. Do not use banned solvents.	Visual Inspection 10X Readable marking, no decoloration or stains. No physical damage.

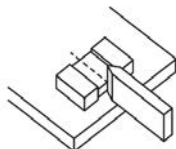
Environmental Compliance

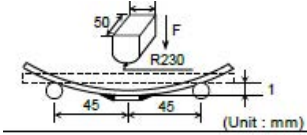

Lead (Pb)-free, RoHS, and REACH compliant without exemptions.

Table 3 – KONNEKT Land Pattern Design Recommendations per IPC-7351 (mm)

Chip Number	Orientation	EIA SIZE CODE	METRIC SIZE CODE	Median (Nominal) Land Protrusion				
				C	Y	X	V1	V2
2	Standard and Low Loss	1812	4532	2.05	1.40	3.50	6.00	4.00
3	Standard			2.05	1.40	3.50	6.00	4.00
	Low loss			2.05	1.40	5.90	6.00	6.40

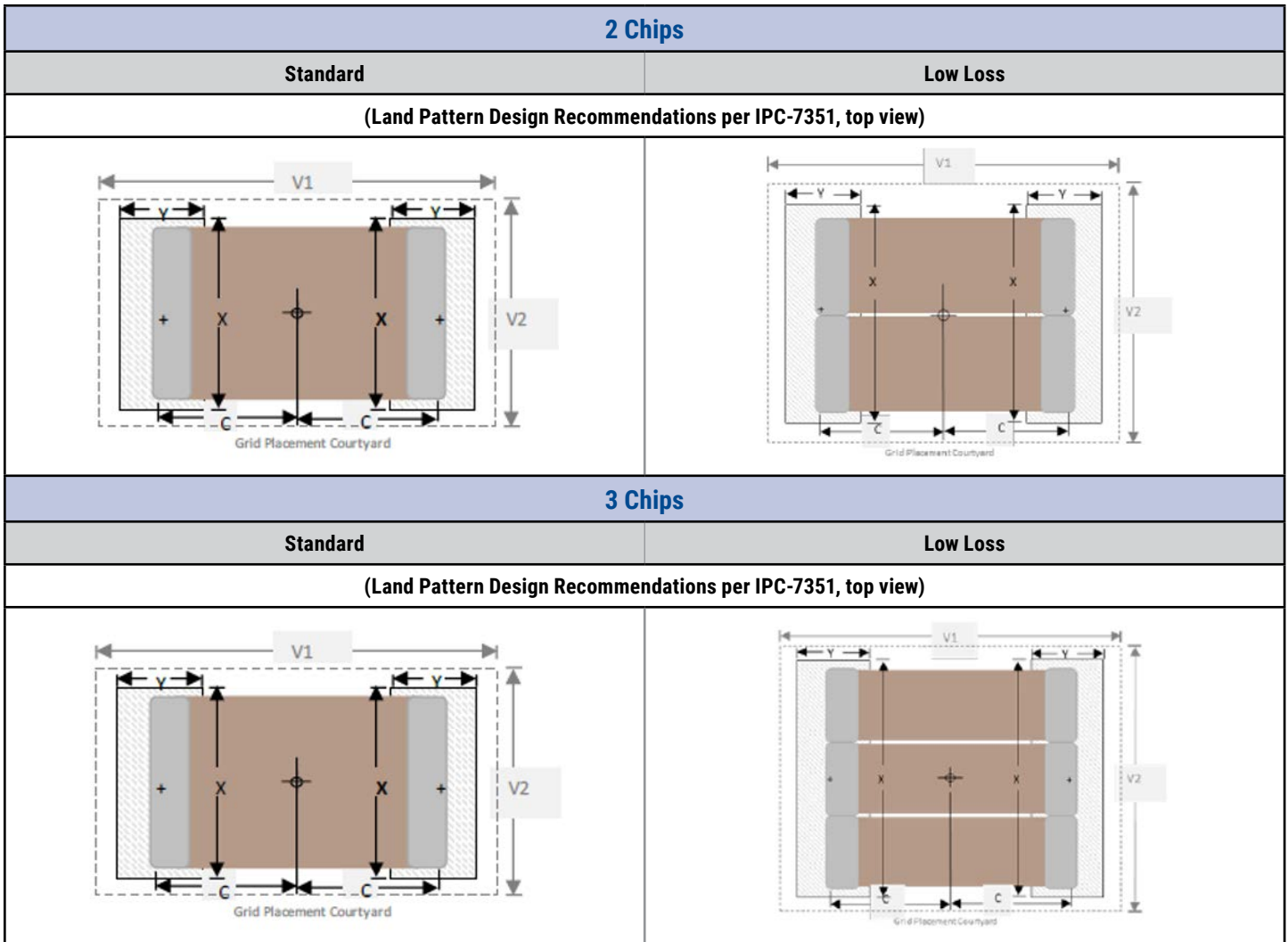

Soldering Process

Recommended Reflow Soldering Profile

KEMET's KONNEKT family of high density surface mount multilayer ceramic capacitors (SMD MLCCs) are compatible with convection and IR reflow techniques. Preheating of these components is recommended to avoid extreme thermal stress. KEMET's recommended profile conditions for convection and IR reflow reflect the profile conditions of the IPC/J-STD-020 standard for moisture sensitivity testing. These devices can safely withstand a maximum of three reflow passes at these conditions.

Profile Feature	Termination Finish
	100% matte Sn
Preheat/Soak	
Temperature Minimum (T_{smin})	150°C
Temperature Maximum (T_{smax})	200°C
Time (t_s) from T_{smin} to T_{smax}	60 – 120 seconds
Ramp-Up Rate (T_L to T_p)	3°C/second maximum
Liquidous Temperature (T_L)	217°C
Time Above Liquidous (t_L)	60 – 150 seconds
Peak Temperature (T_p)	260°C
Time Within 5°C of Maximum Peak Temperature (t_p)	30 seconds maximum
Ramp-Down Rate (T_p to T_L)	6°C/second maximum
Time 25°C to Peak Temperature	8 minutes maximum

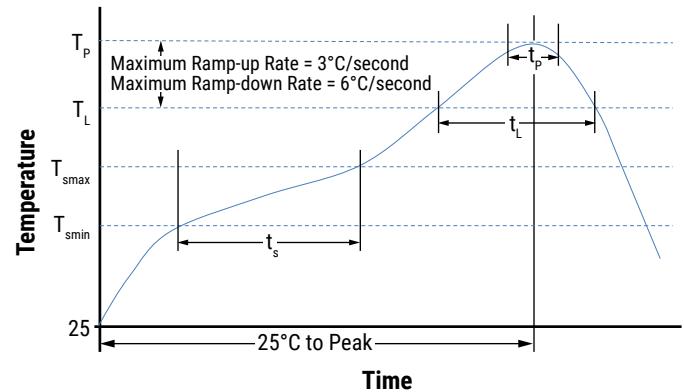

Note: All temperatures refer to the center of the package, measured on the capacitor body surface that is facing up during assembly reflow.

Storage & Handling

Ceramic chip capacitors should be stored in normal working environments. While the chips themselves are quite robust in other environments, solderability will be degraded by exposure to high temperatures, high humidity, corrosive atmospheres, and long term storage. In addition, packaging materials will be degraded by high temperature – reels may soften or warp and tape peel force may increase. KEMET recommends that maximum storage temperature not exceed 40°C and maximum storage humidity not exceed 70% relative humidity. In addition, temperature fluctuations should be minimized to avoid condensation on the parts and atmospheres should be free of chlorine and sulfur bearing compounds. For optimized solderability chip stock should be used promptly, preferably within 1.5 years upon receipt.

Construction

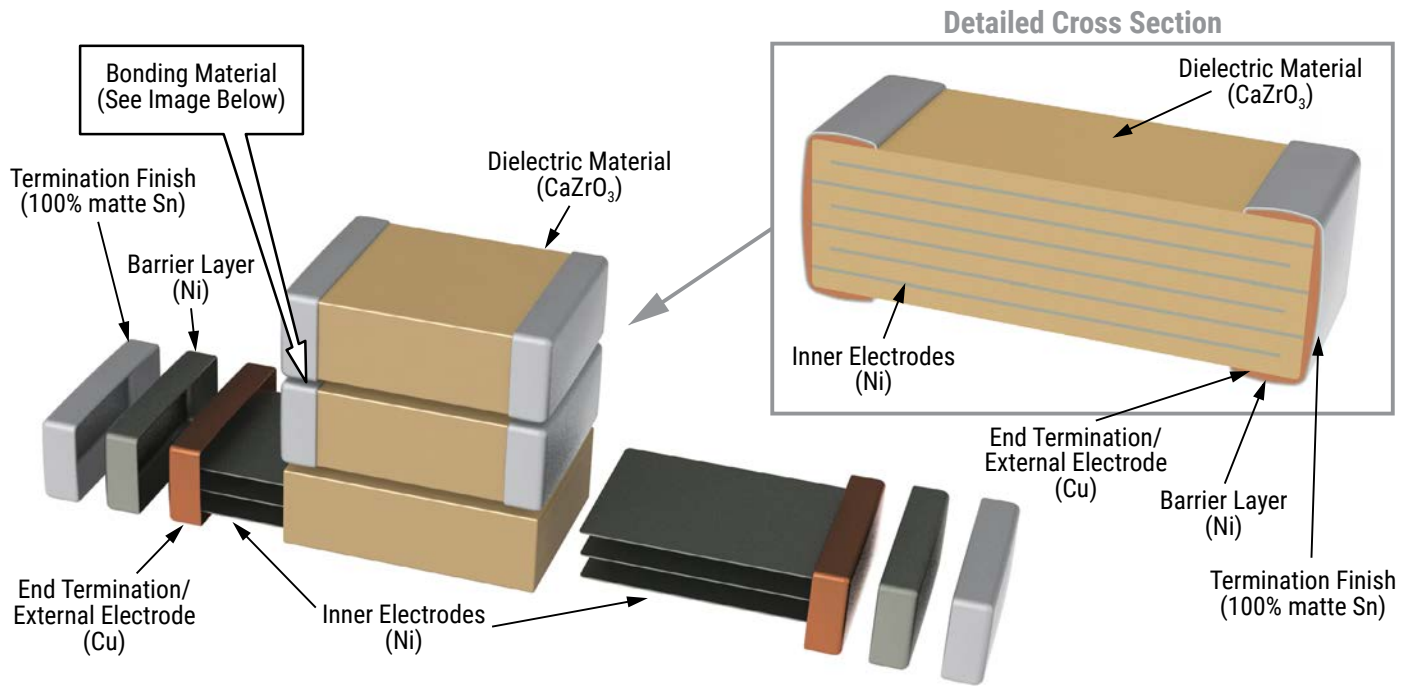

Bonding Material

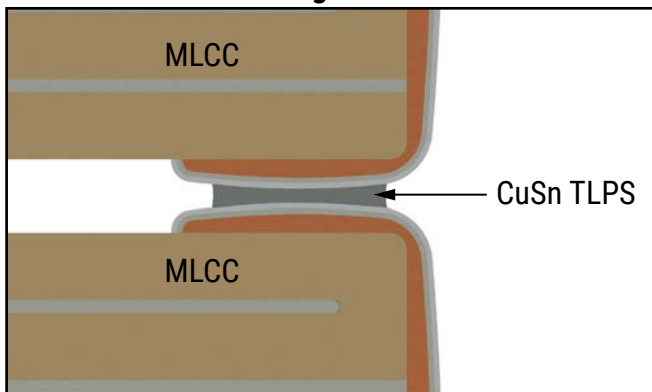

Tape & Reel Packaging Information

KEMET offers multilayer ceramic chip capacitors packaged in 8, 12, 16 and 24 mm tape on 7" and 13" reels in accordance with EIA Standard 481. This packaging system is compatible with all tape-fed automatic pick and place systems. See Table 1B for details on reeling quantities for commercial chips.

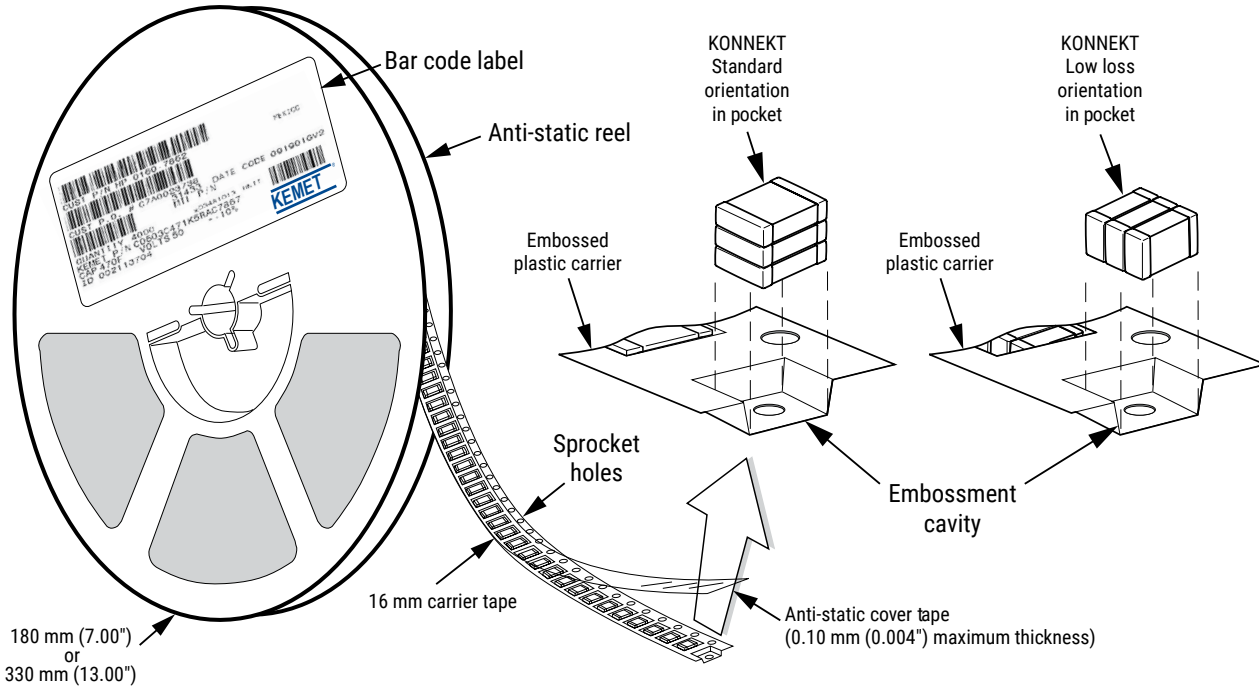

Table 4 – Carrier Tape Configuration, Embossed Plastic (mm)

EIA Case Size	Chip Number	Tape Size (W)*	Embossed Plastic	
			7" Reel	13" Reel
			Pitch (P ₁) ²	
KONNEKT 1812	2	16	8	8
	3	16	12	12

1. Refer to Figures 1 and 2 for W and P₁ carrier tape reference locations.
2. Refer to Tables 4 and 5 for tolerance specifications.

Figure 1 – Embossed (Plastic) Carrier Tape Dimensions

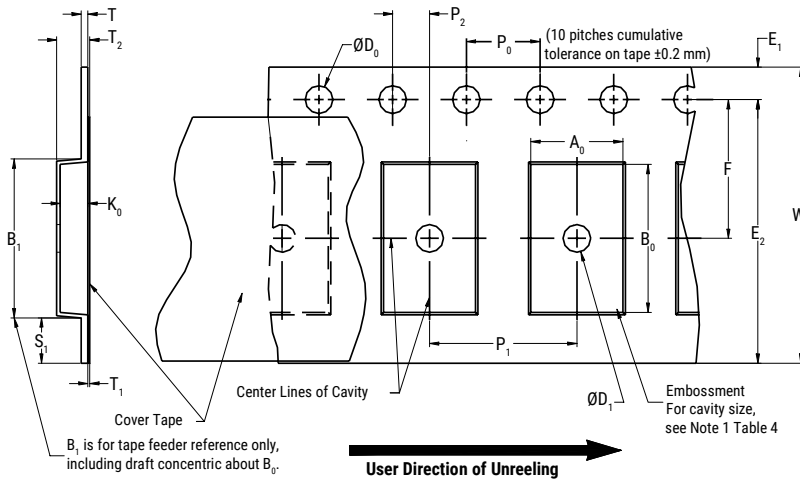

Table 5 – Embossed (Plastic) Carrier Tape Dimensions

Metric will govern

Constant Dimensions – Millimeters (Inches)									
Tape Size	D ₀	D ₁ Minimum Note 1	E ₁	P ₀	P ₂	R Reference Note 2	S ₁ Minimum Note 3	T Maximum	T ₁ Maximum
16 mm	1.5 +0.10/-0.0 (0.059 +0.004/-0.0)	1.5 (0.059)	1.75±0.10 (0.069±0.004)	4.0±0.10 (0.157±0.004)	2.0±0.05 (0.079±0.002)	30 (1.181)	0.600 (0.024)	0.600 (0.024)	0.100 (0.004)
Variable Dimensions – Millimeters (Inches)									
Tape Size	Pitch	B ₁ Maximum Note 4	E ₂ Minimum	F	P ₁	T ₂ Maximum	W Maximum	A ₀ , B ₀ & K ₀	
16 mm	Triple (12mm)	12.1 (0.476)	14.25 (0.561)	7.5±0.05 (0.138±0.002)	12.0±0.10 (0.157±0.004)	4.6 (0.181)	16.3 (0.642)	Note 5	

- The embossment hole location shall be measured from the sprocket hole controlling the location of the embossment. Dimensions of embossment location and hole location shall be applied independent of each other.
- The tape with or without components shall pass around R without damage (see Figure 6).
- If S₁ < 1.0 mm, there may not be enough area for cover tape to be properly applied (see EIA Document 481 paragraph 4.3 (b)).
- B₁ dimension is a reference dimension for tape feeder clearance only.
- The cavity defined by A₀, B₀ and K₀ shall surround the component with sufficient clearance that:
 - the component does not protrude above the top surface of the carrier tape.
 - the component can be removed from the cavity in a vertical direction without mechanical restriction, after the top cover tape has been removed.
 - rotation of the component is limited to 20° maximum for 8 and 12 mm tapes and 10° maximum for 16 mm tapes (see Figure 3).
 - lateral movement of the component is restricted to 0.5 mm maximum for 8 mm and 12 mm wide tape and to 1.0 mm maximum for 16 mm tape (see Figure 4)
 - For KPS Series product, A₀ and B₀ are measured on a plane 0.3 mm above the bottom of the pocket.
 - see Addendum in EIA Document 481 for standards relating to more precise taping requirements.

Packaging Information Performance Notes

- 1. Cover Tape Break Force:** 1.0 kg minimum.
- 2. Cover Tape Peel Strength:** The total peel strength of the cover tape from the carrier tape shall be:

Tape Width	Peel Strength
16 mm	0.1 to 1.3 Newton (10 to 130 gf)

The direction of the pull shall be opposite the direction of the carrier tape travel. The pull angle of the carrier tape shall be 165° to 180° from the plane of the carrier tape. During peeling, the carrier and/or cover tape shall be pulled at a velocity of 300±10 mm/minute.

- 3. Labeling:** Bar code labeling (standard or custom) shall be on the side of the reel opposite the sprocket holes. Refer to EIA Standards 556 and 624.

Figure 2 – Maximum Component Rotation

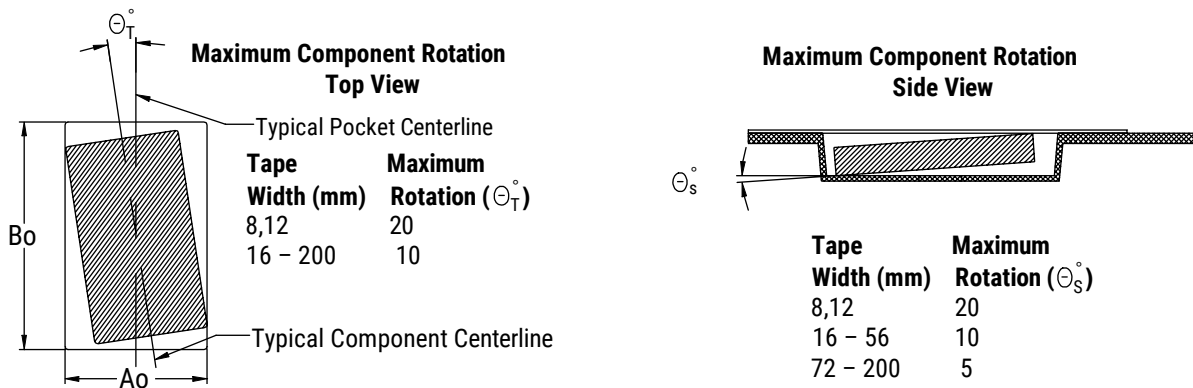

Figure 3 – Maximum Lateral Movement

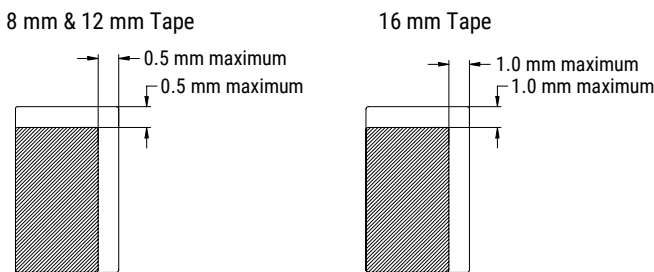

Figure 4 – Bending Radius

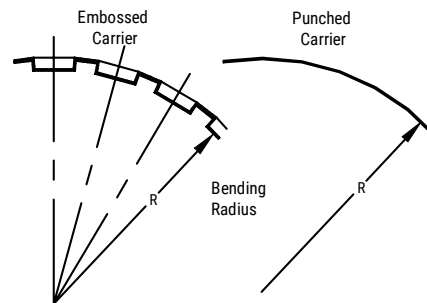

Figure 5 – Reel Dimensions



Note: Drive spokes optional; if used, dimensions B and D shall apply.

Table 6 – Reel Dimensions

Metric will govern

Constant Dimensions – Millimeters (Inches)				
Tape Size	A	B Minimum	C	D Minimum
16 mm	178±0.20 (7.008±0.008) or 330±0.20 (13.000±0.008)	1.5 (0.059)	13.0 +0.5/-0.2 (0.521 +0.02/-0.008)	20.2 (0.795)
Variable Dimensions – Millimeters (Inches)				
Tape Size	N Minimum See Note 2, Tables 2-3	W ₁	W ₂ Maximum	W ₃
16 mm	50 (1.969)	16.4 +2.0/-0.0 (0.646 +0.078/-0.0)	22.4 (0.882)	Shall accommodate tape width without interference

Figure 6 – Tape Leader & Trailer Dimensions



Figure 7 – Maximum Camber

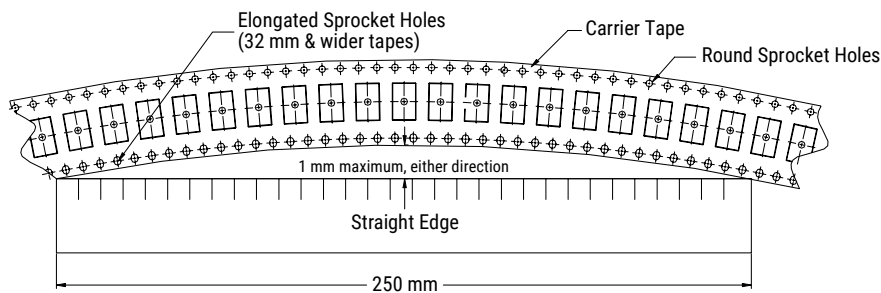

KEMET Electronics Corporation Sales Offices

For a complete list of our global sales offices, please visit www.kemet.com/sales.

Disclaimer

All product specifications, statements, information and data (collectively, the "Information") in this datasheet are subject to change. The customer is responsible for checking and verifying the extent to which the Information contained in this publication is applicable to an order at the time the order is placed. All Information given herein is believed to be accurate and reliable, but it is presented without guarantee, warranty, or responsibility of any kind, expressed or implied.

Statements of suitability for certain applications are based on KEMET Electronics Corporation's ("KEMET") knowledge of typical operating conditions for such applications, but are not intended to constitute – and KEMET specifically disclaims – any warranty concerning suitability for a specific customer application or use. The Information is intended for use only by customers who have the requisite experience and capability to determine the correct products for their application. Any technical advice inferred from this Information or otherwise provided by KEMET with reference to the use of KEMET's products is given gratis, and KEMET assumes no obligation or liability for the advice given or results obtained.

Although KEMET designs and manufactures its products to the most stringent quality and safety standards, given the current state of the art, isolated component failures may still occur. Accordingly, customer applications which require a high degree of reliability or safety should employ suitable designs or other safeguards (such as installation of protective circuitry or redundancies) in order to ensure that the failure of an electrical component does not result in a risk of personal injury or property damage.

Although all product-related warnings, cautions and notes must be observed, the customer should not assume that all safety measures are indicated or that other measures may not be required.

KEMET is a registered trademark of KEMET Electronics Corporation.