

1 Form B Solid State Relay

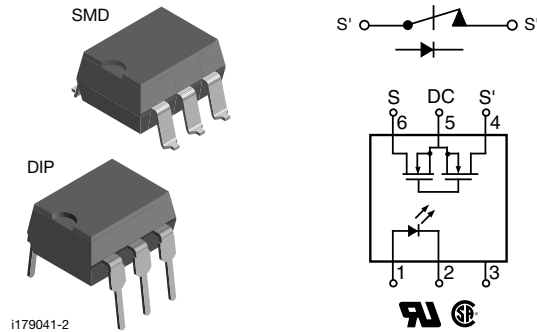

LINKS TO ADDITIONAL RESOURCES



DESCRIPTION

The LH1501 relays are SPST normally closed switches (1 form B) that can replace electromechanical relays in many applications. The relays are constructed as a multi-chip hybrid device. Actuation control is via an infrared LED. The output switch is a combination of a photodiode array with MOSFET switches and control circuitry. The relays can be configured for AC/DC or DC only operation.

FEATURES

- Isolation test voltage 3750 V_{RMS}
- Typical R_{ON} 20 Ω
- Load voltage 350 V
- Clean bounce free switching
- Low power consumption
- SMD lead available on tape and reel
- Material categorization: for definitions of compliance please see www.vishay.com/doc?99912



RoHS
COMPLIANT

APPLICATIONS

- General telecom switching
- Security equipment
- Instrumentation
- Industrial controls

AGENCY APPROVALS

- [UL](#)
- [VDE](#)

ORDERING INFORMATION	
<div style="display: flex; justify-content: space-around; align-items: center;"> <div style="text-align: center;"> <div style="border: 1px solid black; padding: 2px 5px;">L</div> <div style="border: 1px solid black; padding: 2px 5px;">H</div> <div style="border: 1px solid black; padding: 2px 5px;">1</div> <div style="border: 1px solid black; padding: 2px 5px;">5</div> <div style="border: 1px solid black; padding: 2px 5px;">0</div> <div style="border: 1px solid black; padding: 2px 5px;">1</div> </div> <div style="text-align: center;"> <div style="border: 1px solid black; padding: 2px 5px;">B</div> </div> <div style="text-align: center;"> <div style="border: 1px solid black; padding: 2px 5px;">#</div> <div style="border: 1px solid black; padding: 2px 5px;">#</div> </div> <div style="text-align: center;"> <div style="border: 1px solid black; padding: 2px 5px;">T</div> <div style="border: 1px solid black; padding: 2px 5px;">R</div> </div> <div style="text-align: center;"> </div> </div> <p style="text-align: center;"> PART NUMBER ELECTR. VARIATION PACKAGE CONFIG. TAPE AND REEL </p>	
PACKAGE	UL, CSA
SMD-6, tubes	LH1501BAB
SMD-6, tape and reel	LH1501BABTR
DIP-6, tubes	LH1501BT



ABSOLUTE MAXIMUM RATINGS (T _{amb} = 25 °C, unless otherwise specified)				
PARAMETER	TEST CONDITION	SYMBOL	VALUE	UNIT
INPUT				
LED continuous forward current		I _F	50	mA
LED reverse voltage	I _R ≤ 10 μA	V _R	5	V
OUTPUT				
DC or peak AC load voltage	I _L ≤ 50 μA	V _L	350	V
Continuous DC load current - bidirectional		I _L	150	mA
Continuous DC load current - unidirectional		I _L	200	mA
Peak load current (single shot)	t = 100 ms	I _P	350	mA
SSR				
Ambient temperature range		T _{amb}	-40 to +85	°C
Storage temperature range		T _{stg}	-40 to +125	°C
Pin soldering temperature ⁽¹⁾	t = 10 s max.	T _{sld}	260	°C
Input to output isolation voltage	t = 1 s, I _{ISO} = 10 μA max.	V _{ISO}	3750	V _{RMS}
Output power dissipation (continuous)		P _{diss}	550	mW

Notes

- Stresses in excess of the absolute maximum ratings can cause permanent damage to the device. Functional operation of the device is not implied at these or any other conditions in excess of those given in the operational sections of this document. Exposure to absolute maximum ratings for extended periods of the time can adversely affect reliability
- ⁽¹⁾ Refer to reflow profile for soldering conditions for surface mounted devices (SMD). Refer to wave profile for soldering conditions for through hole devices (DIP)

ELECTRICAL CHARACTERISTICS (T _{amb} = 25 °C, unless otherwise specified)						
PARAMETER	TEST CONDITION	SYMBOL	MIN.	TYP.	MAX.	UNIT
INPUT						
LED forward current, switch turn-on	I _L = ± 150 mA, t = 10 ms	I _{Fon}	0.2	0.9		mA
LED forward current, switch turn-off	V _L = ± 300 V	I _{Foff}		1	2	mA
LED forward voltage	I _F = 10 mA	V _F	1.15	1.26	1.45	V
OUTPUT						
On-resistance, AC/DC: pin 4, 6 (+) to 5 (-)	I _F = 0 mA, I _L = 50 mA	R _{ON}		20	25	Ω
On-resistance, DC: pin 4, 6 (+) to 5 (-)	I _F = 0 mA, I _L = 100 mA	R _{ON}		5	6.25	Ω
Off-resistance	I _F = 5 mA, V _L = ± 100 V	R _{OFF}	0.1	1.4		GΩ
Off-state leakage current	I _F = 5 mA, V _L = ± 350 V	I _O		0.08	1	μA
Output capacitance	I _F = 5 mA, V _L = 50 V	C _O		35		pF
TRANSFER						
Capacitance (input to output)	V _{ISO} = 1 V	C _{IO}		3		pF

Note

- Minimum and maximum values are testing requirements. Typical values are characteristics of the device and are the result of engineering evaluations. Typical values are for information only and are not part of the testing requirements.

SWITCHING CHARACTERISTICS (T _{amb} = 25 °C, unless otherwise specified)						
PARAMETER	TEST CONDITION	SYMBOL	MIN.	TYP.	MAX.	UNIT
Turn-on time	I _F = 5 mA, I _L = 50 mA	t _{on}		2	3	ms
Turn-off time	I _F = 5 mA, I _L = 50 mA	t _{off}		1	3	ms



TYPICAL CHARACTERISTICS (T_{amb} = 25 °C, unless otherwise specified)

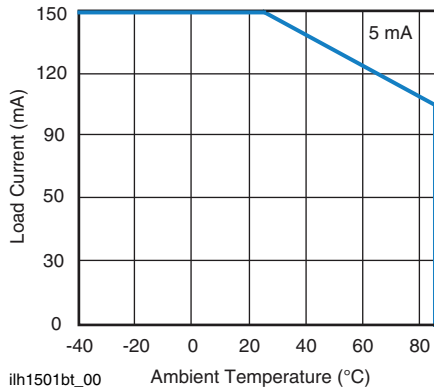
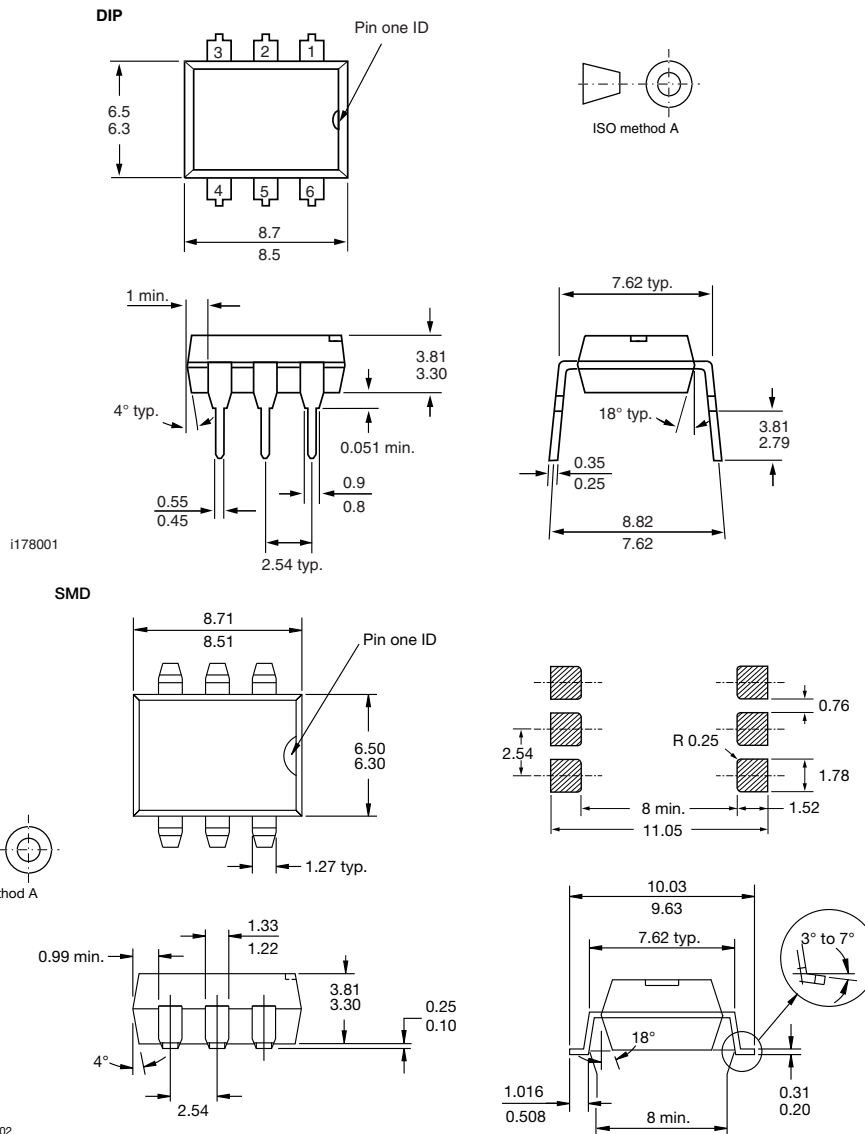
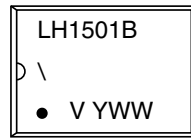

Fig. 1 - Maximum Load Current vs. Ambient Temperature

PACKAGE DIMENSIONS in millimeters



PACKAGE MARKING (example)



Note

- Tape and reel suffix (TR) is not part of the package marking

SOLDER PROFILES

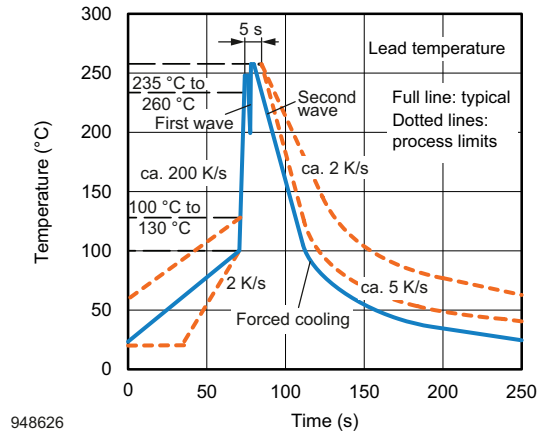

948626

Fig. 2 - Wave Soldering Double Wave Profile According to J-STD-020 for DIP Devices

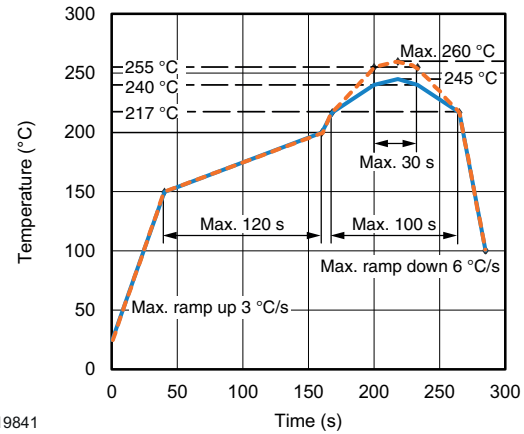

19841

Fig. 3 - Lead (Pb)-free Reflow Solder Profile According to J-STD-020 for SMD Devices

HANDLING AND STORAGE CONDITIONS

ESD level: HBM class 2

Floor life: unlimited

Conditions: $T_{amb} < 30\text{ °C}$, RH < 85 %

Moisture sensitivity level 1, according to J-STD-020



Footprint and Schematic Information for LH1501BAB, LH1501BABTR, LH1501BT

The footprint and schematic symbols for the following parts can be accessed using the associated links. They are available in Eagle, Altium, KiCad, OrCAD / Allegro, Pulsonix, and PADS.

Note that the 3D models for these parts can be found on the Vishay product page.

PART NUMBER	FOOTPRINT / SCHEMATIC
LH1501BAB	www.snapeda.com/parts/LH1501BAB/Vishay/view-part
LH1501BABTR	www.snapeda.com/parts/LH1501BABTR/Vishay/view-part
LH1501BT	www.snapeda.com/parts/LH1501BT/Vishay/view-part

For technical issues and product support, please contact optocoupleranswers@vishay.com.

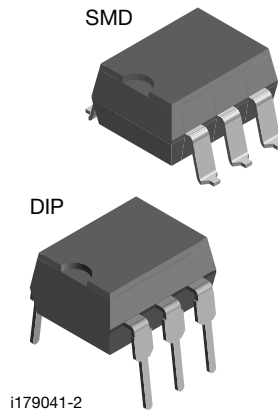



Disclaimer

ALL PRODUCT, PRODUCT SPECIFICATIONS AND DATA ARE SUBJECT TO CHANGE WITHOUT NOTICE TO IMPROVE RELIABILITY, FUNCTION OR DESIGN OR OTHERWISE.

Vishay Intertechnology, Inc., its affiliates, agents, and employees, and all persons acting on its or their behalf (collectively, "Vishay"), disclaim any and all liability for any errors, inaccuracies or incompleteness contained in any datasheet or in any other disclosure relating to any product.

Vishay makes no warranty, representation or guarantee regarding the suitability of the products for any particular purpose or the continuing production of any product. To the maximum extent permitted by applicable law, Vishay disclaims (i) any and all liability arising out of the application or use of any product, (ii) any and all liability, including without limitation special, consequential or incidental damages, and (iii) any and all implied warranties, including warranties of fitness for particular purpose, non-infringement and merchantability.

Statements regarding the suitability of products for certain types of applications are based on Vishay's knowledge of typical requirements that are often placed on Vishay products in generic applications. Such statements are not binding statements about the suitability of products for a particular application. It is the customer's responsibility to validate that a particular product with the properties described in the product specification is suitable for use in a particular application. Parameters provided in datasheets and / or specifications may vary in different applications and performance may vary over time. All operating parameters, including typical parameters, must be validated for each customer application by the customer's technical experts. Product specifications do not expand or otherwise modify Vishay's terms and conditions of purchase, including but not limited to the warranty expressed therein.

Except as expressly indicated in writing, Vishay products are not designed for use in medical, life-saving, or life-sustaining applications or for any other application in which the failure of the Vishay product could result in personal injury or death. Customers using or selling Vishay products not expressly indicated for use in such applications do so at their own risk. Please contact authorized Vishay personnel to obtain written terms and conditions regarding products designed for such applications.

No license, express or implied, by estoppel or otherwise, to any intellectual property rights is granted by this document or by any conduct of Vishay. Product names and markings noted herein may be trademarks of their respective owners.