

# IP54 General Purpose Enclosures

## Technical Specification

Manufactured from ADC12 aluminium, this range offers a versatile, IP54 enclosure solution for applications where light protection against dust and low pressure water spray is required.

15 sizes are available, complete with captive screws, earth screws and PCB guides on selected sizes. Nine sizes are also available with flanges for easy mounting.

Deltron Enclosures can customise any enclosure in our UK factory, including machining, painting, component sourcing and installation to meet your specification, save time and cut your costs. View our Services page on our website for more information.



**For more information:**

Phone: +44 (0)1724 273206

### Features:

- IP54 Rated
- Manufactured from ADC12
- Certified to BS EN 60529:1992
- RoHS Compliant

### Typical Applications:

- Remote Control Systems
- Keyboards
- Display Boards
- Radio Instrumentation

### Available Dimensions (mm):

90 x 36 x 30*	115 x 64 x 30*
115 x 90 x 55*	115 x 65 x 55*
172 x 121 x 55*	172 x 121 x 106*
223 x 147 x 55*	223 x 147 x 106
275 x 176 x 65	141 x 102 x 76
166 x 128 x 76	121 x 101 x 35*
251 x 251 x 99	81 x 56 x 25
61 x 56 x 30	*= Available with Flanges

**Finishes:** Plain Aluminium, Powder or Nylon coat.

**Coating Colours:** Grey, Blue or Black.

Or choose to have your enclosure customised for bespoke finishes and colours.

### DEM Manufacturing

Deltron Emcon House,  
Hargreaves Way,  
Sawcliffe Industrial Park,  
Scunthorpe, DN15 8RF.

**DELTRON** Enclosures

Web: [www.dem-uk.com/deltron-enclosures](http://www.dem-uk.com/deltron-enclosures)

Tel: +44 (0) 1724 273206

Fax: +44 (0) 1724 280353

Email: [sales@dem-uk.com](mailto:sales@dem-uk.com)

REV	DATE	ECN NUMBER	ECR COMMENT
010	06 Jun 2017	C03614	BORDER CHANGE
009	06 Jun 2017	C03614	TORQUE SETTINGS ADDED

LENGTH	WIDTH	HEIGHT	SEAL	TORQUE SETTINGS	PLAIN	POWDER COAT	NYLON COAT
172	121	106	NONE	NONE	459-0060	461-0060*	462-0060*
			IP66	0.3Nm	460-0060	453-0060*	454-0060*
			IP68	0.7Nm	480-0060	481-0060*	482-0060*
			IP68 EMI/RFI	1.0Nm	480-C060	481-C060*	482-C060*
BOX DIMENSION IN MM			COLOUR OPTION - COLOUR SUFFIX * GREY=A / BLUE=B / BLACK = E				

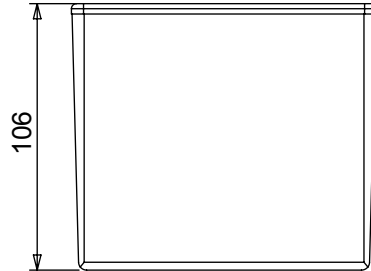
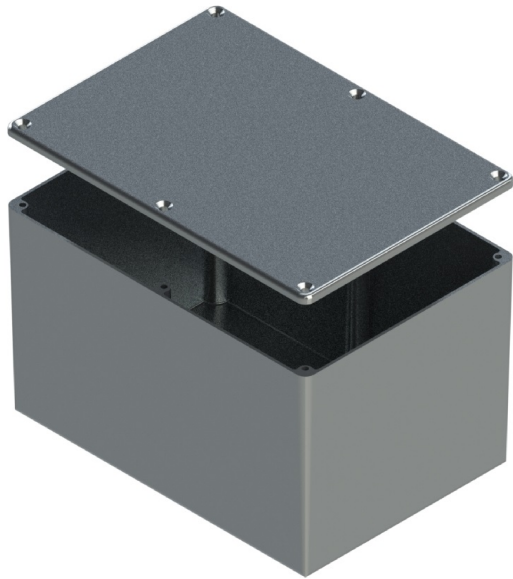

**STANDARD DUTY ENCLOSURE**

- Material grade ADC12/LM2 Die Cast Alloy
- IP Rated available
- Min wall thickness 1.5mm
- Min lid thickness 1.5mm
- Fine textured powder coating and smooth nylon
- Screws stainless steel
- IP68 Tested to 5 metres for 1 hour
- Enclosures can be supplied fully factory customised to your specification

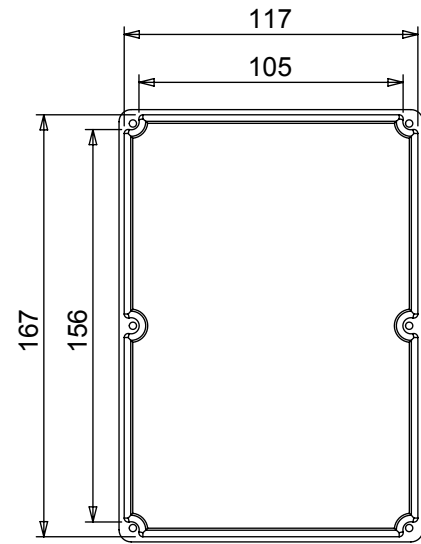
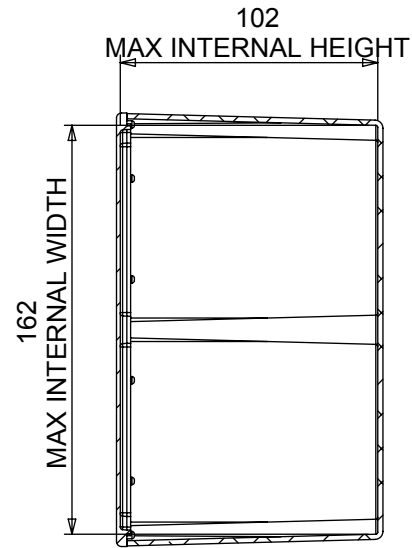
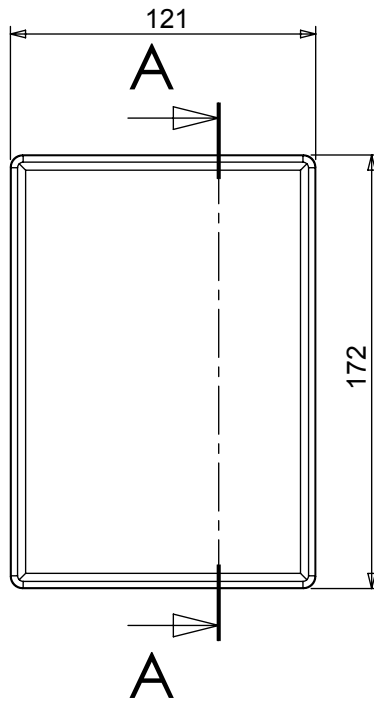
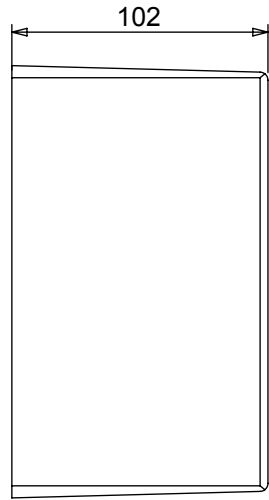
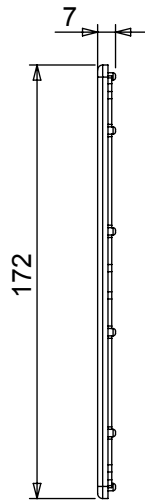

**SECTION A-A**

**DELTRON Components**  
**DELTRON Enclosures**  
**ROXBURGH EMC**

b'es **DEM**  
**Alpha3**  
 manufacturing

+44(0)1724 273200  
 www.dem-uk.com

**PROPRIETARY AND CONFIDENTIAL:**  
 THE INFORMATION CONTAINED IN THIS DRAWING IS THE SOLE PROPERTY OF ALPHA 3 MANUFACTURING. ANY REPRODUCTION IN PART OR AS A WHOLE WITHOUT THE WRITTEN PERMISSION OF ALPHA 3 MANUFACTURING IS PROHIBITED.

DEM Manufacturing is a division of Alpha 3 Manufacturing LTD  
 DEM Manufacturing, Deltron Emcon House, Hargreaves Way,  
 Sawcliffe Ind. Park, Scunthorpe, North Lincolnshire, DN15 8RF, UK

UNLESS OTHERWISE SPECIFIED DIMENSIONS ARE IN MILLIMETRES  
 LINEAR & RADIAL TOLERANCE:  
**NO DECIMAL PLACES**  
**1 DECIMAL PLACE**  
**2 DECIMAL PLACES**  
**ANGULAR TOLERANCE:**

**IF IN DOUBT ASK! DO NOT SCALE DRAWING!**

FINISH: SEE NOTES  
 MATERIAL: ALUMINIUM ALLOY

THE FINISHED PRODUCT SHOULD BE CLEAN AND FREE FROM ALL LIQUIDS AND DEBRIS. SURFACES SHOULD BE OF UNIFORM APPEARANCE FREE FROM SHARP EDGES, BURRS AND CORROSION

AUTHOR: Alex Yau  
 EDITOR: DT  
 APPROVER: DT

THIRD ANGLE PROJECTION

TITLE: PLAIN ENCLOSURE  
 FILE: F ENCLOSURE  
 PART: BOX & LID ASSEMBLY

SHEET 1 OF 1  
 SCALE 1:3 A4

ISSUE/REV: 010  
 VERSION: 64  
 RELEASED  
 EDIT DATE: 06 Jun 2017