

Features

- Fast Switching Speed
- For General Purpose Switching
- Applications High Conductance

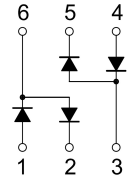

GCH! 6'



Schematic Diagram

Absolute Maximum Ratings (T_A=25°C unless otherwise specified)

Parameter	Symbol	Value	Unit
Peak Repetitive Peak Reverse Voltage	V _{RRM}	75	V
Working Peak Reverse Voltage	V _{RWM}		
DC Blocking Voltage	V _R		
Forward Continuous Current	I _{FM}	300	mA
Average Rectified Output Current	I _O	150	mA
Non-Repetitive Peak Forward Surge Current @ t=8.3ms	I _{FSM}	2.0	A
Power Dissipation	P _D	200	mW
Thermal Resistance Junction to Ambient	R _{θJA}	625	°C/W
Operating Junction Temperature	T _J	150	°C
Storage Temperature	T _{STG}	-55 to +150	°C

Electrical Characteristics (T_A=25°C unless otherwise specified)

Parameter	Symbol	Test Conditions	Min	Max	Unit
Reverse Voltage	V _(BR)	I _R =2.5μA	75	—	V
Reverse Current	I _R	V _R =75V	—	2.5	μA
		V _R =20V	—	25	nA
Forward Voltage	V _F	I _F =1mA	—	0.715	V
		I _F =10mA	—	0.855	
		I _F =50mA	—	1	
		I _F =150mA	—	1.25	
Total Capacitance	C _{tot}	V _R =0, f=1MHz	—	2	pF
Reverse Recovery Time	t _{rr}	I _F = I _R =10mA, I _{tr} =0.1×I _R , R _L =100Ω	—	4	ns

Typical Characteristics Curves

Forward Characteristics

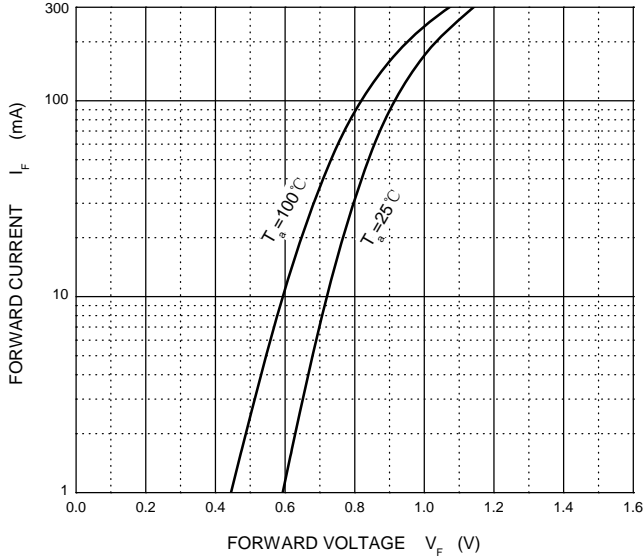

Reverse Characteristics

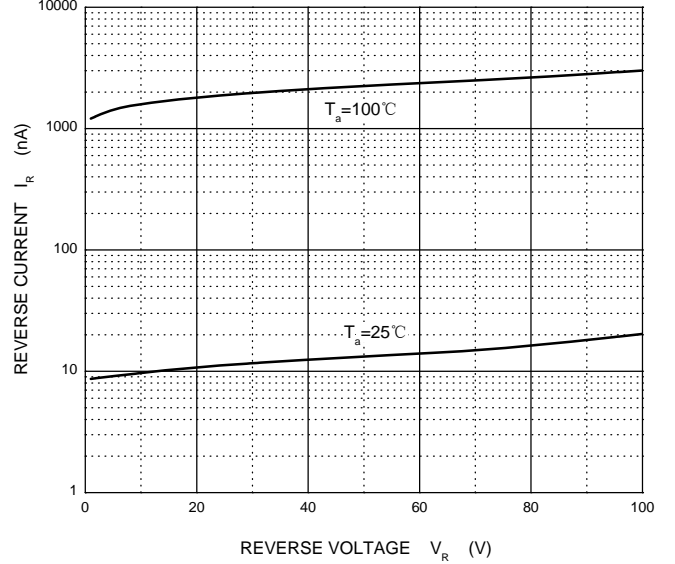

Capacitance Characteristics

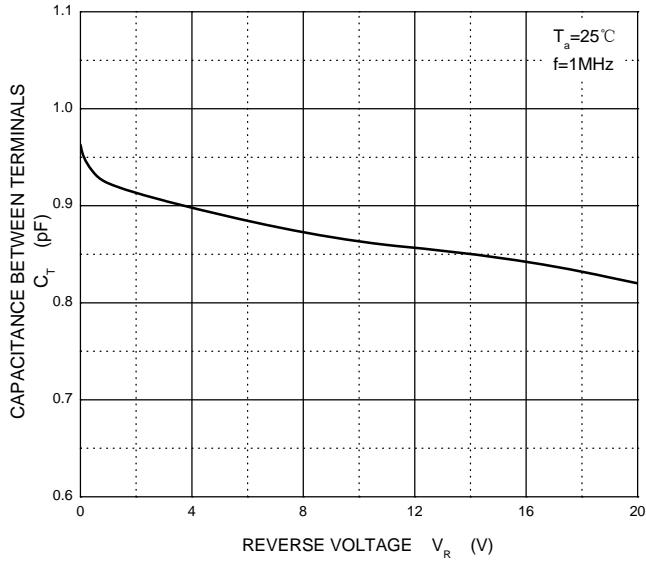

Power Derating Curve

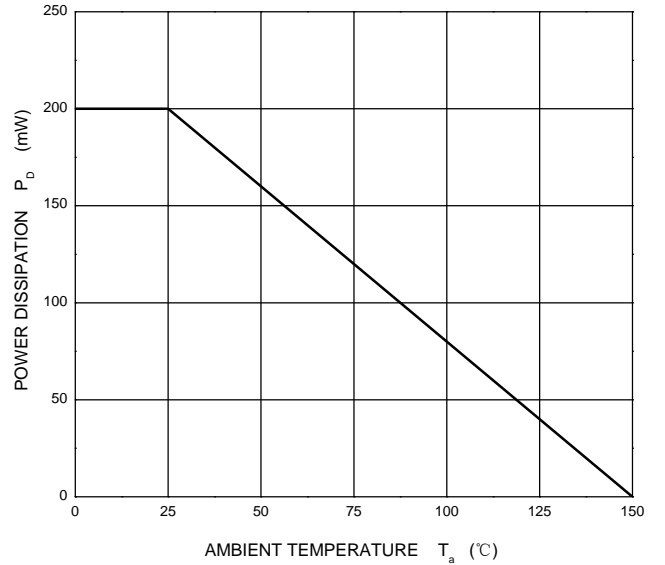

Package Outline Dimensions SOT-363

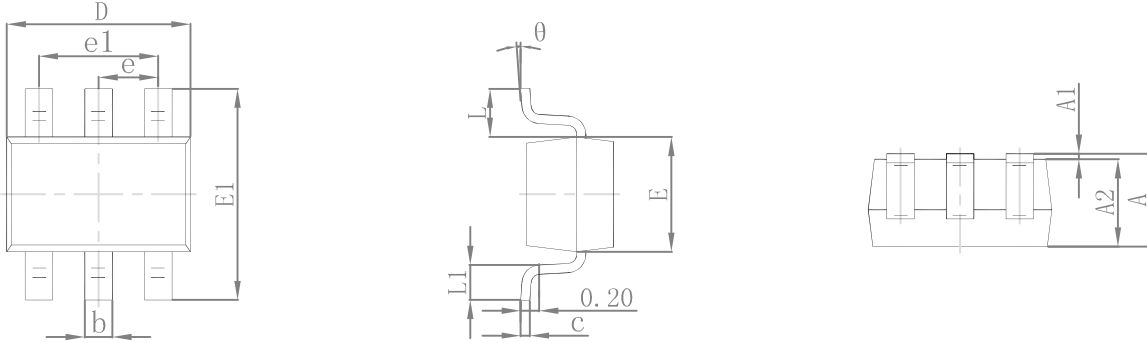

Symbol	Dimensions In Millimeters		Dimensions In Inches	
	Min	Max	Min	Max
A	0.900	1.100	0.035	0.043
A1	0.000	0.100	0.000	0.004
A2	0.900	1.000	0.035	0.039
b	0.150	0.350	0.006	0.014
c	0.100	0.150	0.004	0.006
D	2.000	2.200	0.079	0.087
E	1.150	1.350	0.045	0.053
E1	2.150	2.400	0.085	0.094
e	0.650 TYP		0.026 TYP	
e1	1.200	1.400	0.047	0.055
L	0.525 REF		0.021 REF	
L1	0.260	0.460	0.010	0.018
θ	0°	8°	0°	8°

Suggested Pad Layout

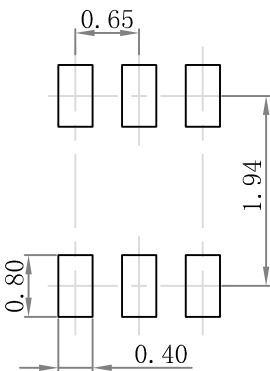

- Note:
1. Controlling dimension: in millimeters.
 2. General tolerance: $\pm 0.05\text{mm}$.
 3. The pad layout is for reference purposes only.

Order Information

Device	Package	Marking	Carrier	Quantity	HSF Status
BAV99DW	SOT-363	KJG	Tape & Reel	3000pcs / Reel	RoHS Compliant