

M5StickC PLUS

SKU:K016-P



Tutorial&Quick-Start

Choose the development platform you want to use, view the corresponding tutorial&quick-Start.

[UIFlow](#) [Arduino](#)

M5StickC-Plus can use most programs of M5StickC. Due to hardware differences such as screens, please download the M5StickC-Plus library before compiling the program and modify the header file reference in the program as [M5StickCPlus.h](#).

Description

M5StickC PLUS is powered by ESP32-PICO-D4 with Bluetooth 4.0 and WiFi and is an upgrade of the original **M5StickC** with a bigger screen .It is a portable, easy-to-use, open source, IoT development board. This tiny device will enable you to realize your ideas, enrich your creativity, and speed up your IoT prototyping. Developing with M5StickC PLUS takes away a lot of the pains from the development process. M5StickC Plus is one of the core devices in M5Stacks product series. The compact body is integrated with rich hardware resources, such as infrared, RTC, Microphone, LED, IMU, Buttons, PMU,etc. Improvements from the regular StickC are a buzzer, bigger screen (1.14-inch, 135 * 240 resolution LCD Screen) and more stable hardware design. This revision increases the display area by 18.7%, and the battery capacity from 95mAh to 120mAh. It also supports the HAT and Unit family of products.

Power switch operation:

- Power on : Press power button for 2 seconds
- Power off : Press power button for 6 seconds

Notice:

- Baud rate supported by M5StickC Plus: 1200 ~115200, 250K, 500K, 750K, 1500K
- G36/G25 share the same port, when one of the pins is used, the other pin should be set as a floating input
- For example, to use the G36 pin as the ADC input, Configuration the G25 pin as FLOATING
- The input range of VBUS_VIN and VBUS_USB is limited to 4.8-5.5V, and the internal battery will be charged through AXP192 power management when VBUS is powered.

```
{
  M5.begin();
  pinMode(36, INPUT);
  gpio_pulldown_dis(GPIO_NUM_25);
  gpio_pullup_dis(GPIO_NUM_25);
}
```

Product Features

- ESP32-based support BLE 4.2 and WiFi
- Built-in 6-Axis IMU
- Red LED
- IR transmitter
- Microphone
- RTC
- Buttons, LCD(1.14 inch)
- Built-in Lipo Battery
- Extendable Socket
- Built-in Passive Buzzer
- Wearable & Wall mounted
- Development Platform [UIFlow](#), [MicroPython](#), [Arduino](#)

Include

- 1x M5StickC Plus

Applications

- Internet of things terminal controller
- Wearable devices
- Stem education product
- DIY creation

USB Drive problems

UnitV/M5StickV/M5StickC/ATOM may not work without driver in some systems. Users can manually install **FTDI driver** to fix this problem. Take the win10 environment as an example, download the driver file that matches the operating system, decompress it, and install it through the device manager. (Note: In some system environments, the driver needs to be installed twice for the driver to take effect. The unrecognized device name is usually **M5Stack** or **USB Serial**. Windows recommends using the driver file to install directly in the device manager (custom Update), the executable file installation method may not work properly).



← Update Drivers - USB Serial Port
[Browse for drivers on your computer](#)



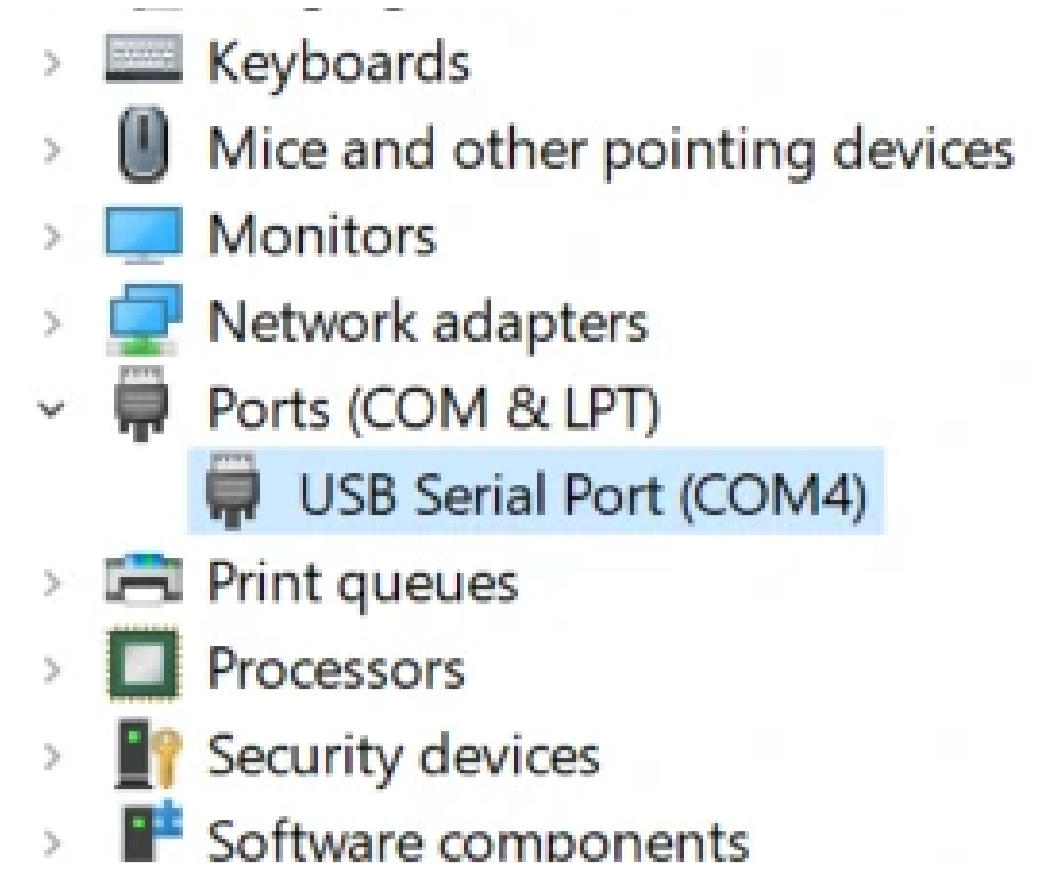
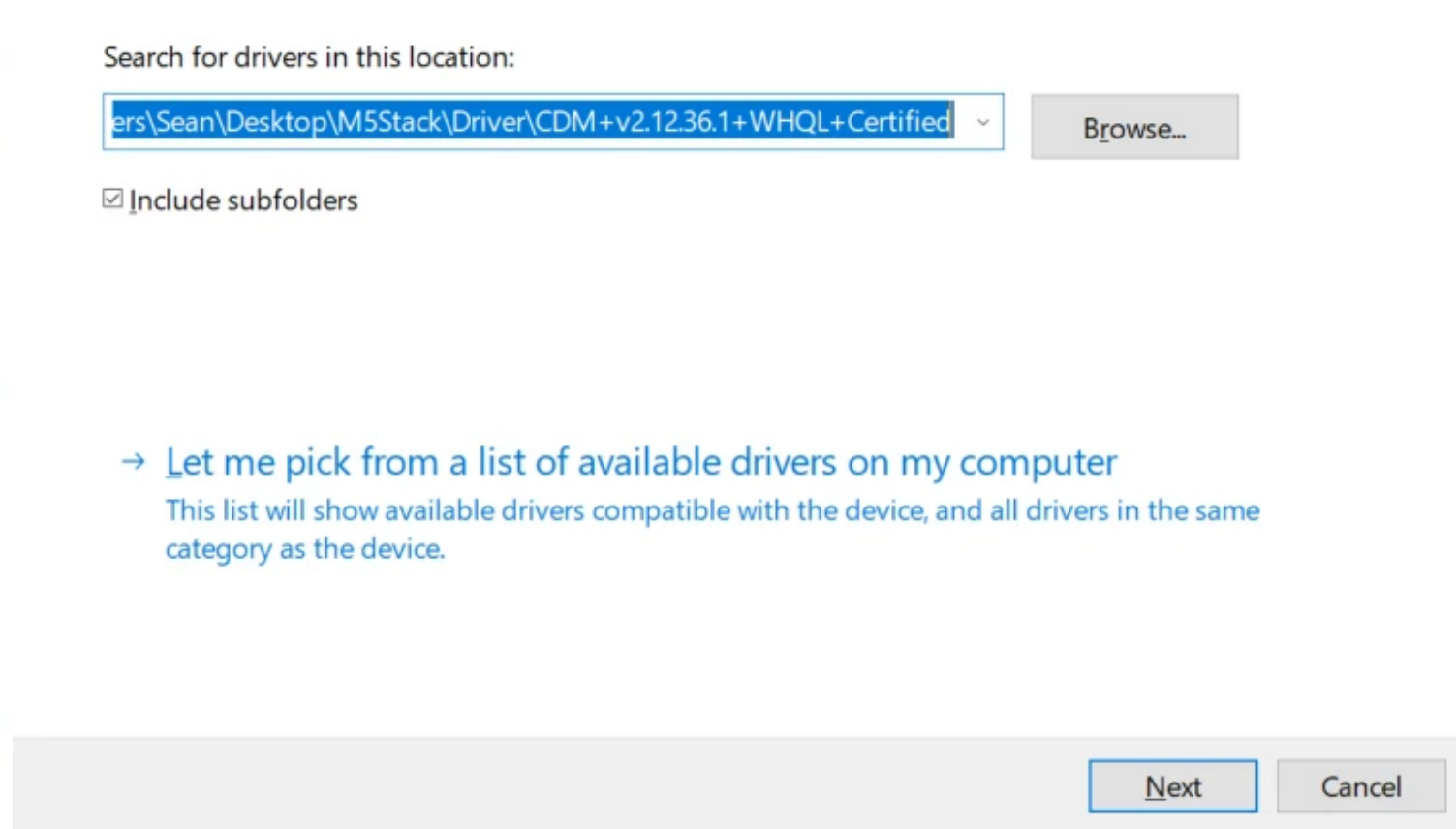
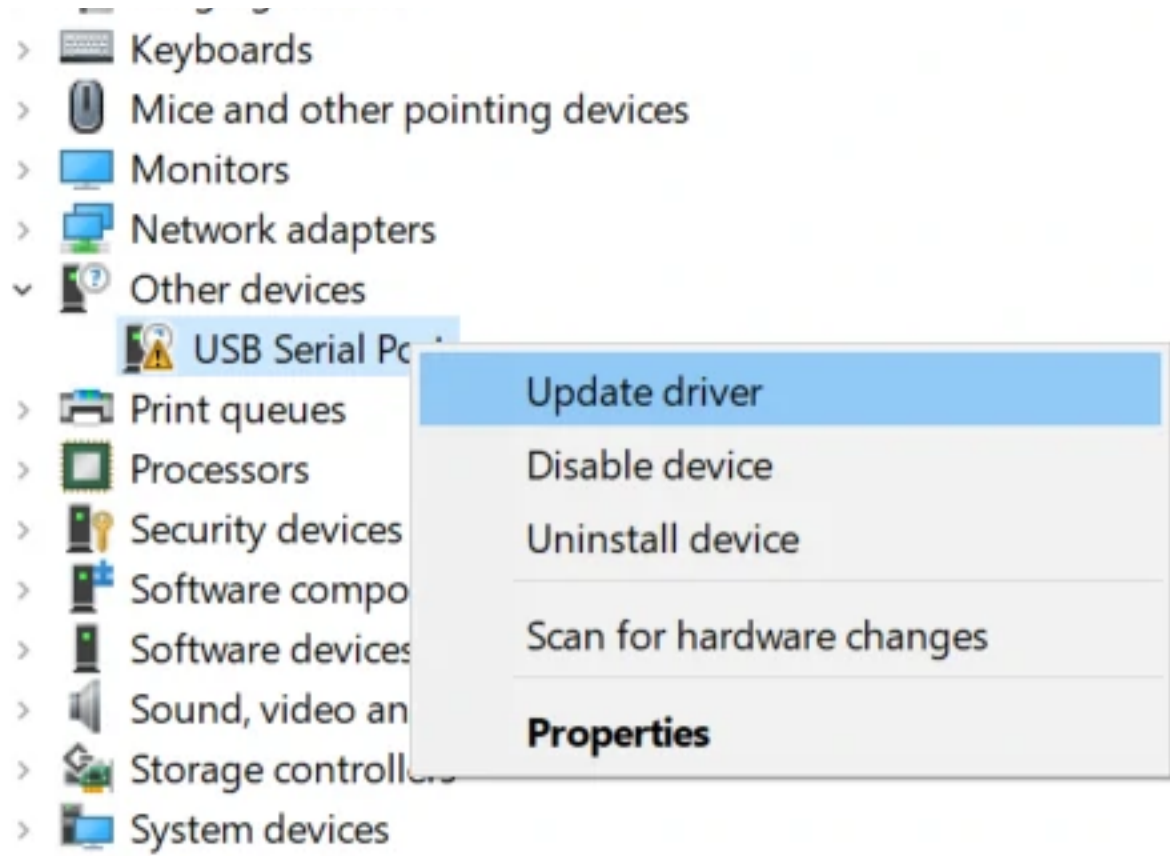

Specification

Resources	Parameter
ESP32	240MHz dual core, 600 DMIPS, 520KB SRAM, Wi-Fi, dual mode Bluetooth
Flash Memory	4MB
Power Input	5V @ 500mA
Port	TypeC x 1, GROVE(I2C+I/O+UART) x 1
LCD screen	1.14 inch, 135*240 Colorful TFT LCD, ST7789v2
Button	Custom button x 2
LED	RED LED
MEMS	MPU6886
Buzzer	built-in buzzer
IR	Infrared transmission
MIC	SPM1423
RTC	BM8563
PMU	AXP192
Battery	120 mAh @ 3.7V
Antenna	2.4G 3D Antenna
PIN port	G0, G25/G36, G26, G32, G33
Operating Temperature	32°F to 104°F (0°C to 40°C)
Net weight	15g
Gross weight	21g
Product Size	48.2*25.5*13.7mm
Package Size	65*25*15mm
Case Material	Plastic (PC)

EasyLoader

EasyLoader is a concise and fast program writer, which has a built-in case program related to the product. It can be burned to the main control by simple steps to perform a series of function verification. Please install the corresponding driver according to the

device type. M5Core host [Please click here to view the CP210X driver installation tutorial](#), M5StickC/M5StickV/M5StickT/ATOM series can be used without driver)

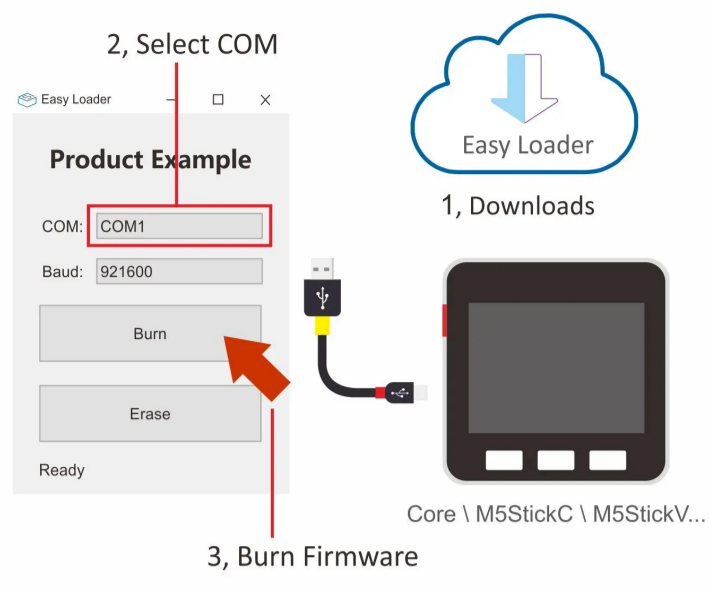

Windows

MacOS

Schematic

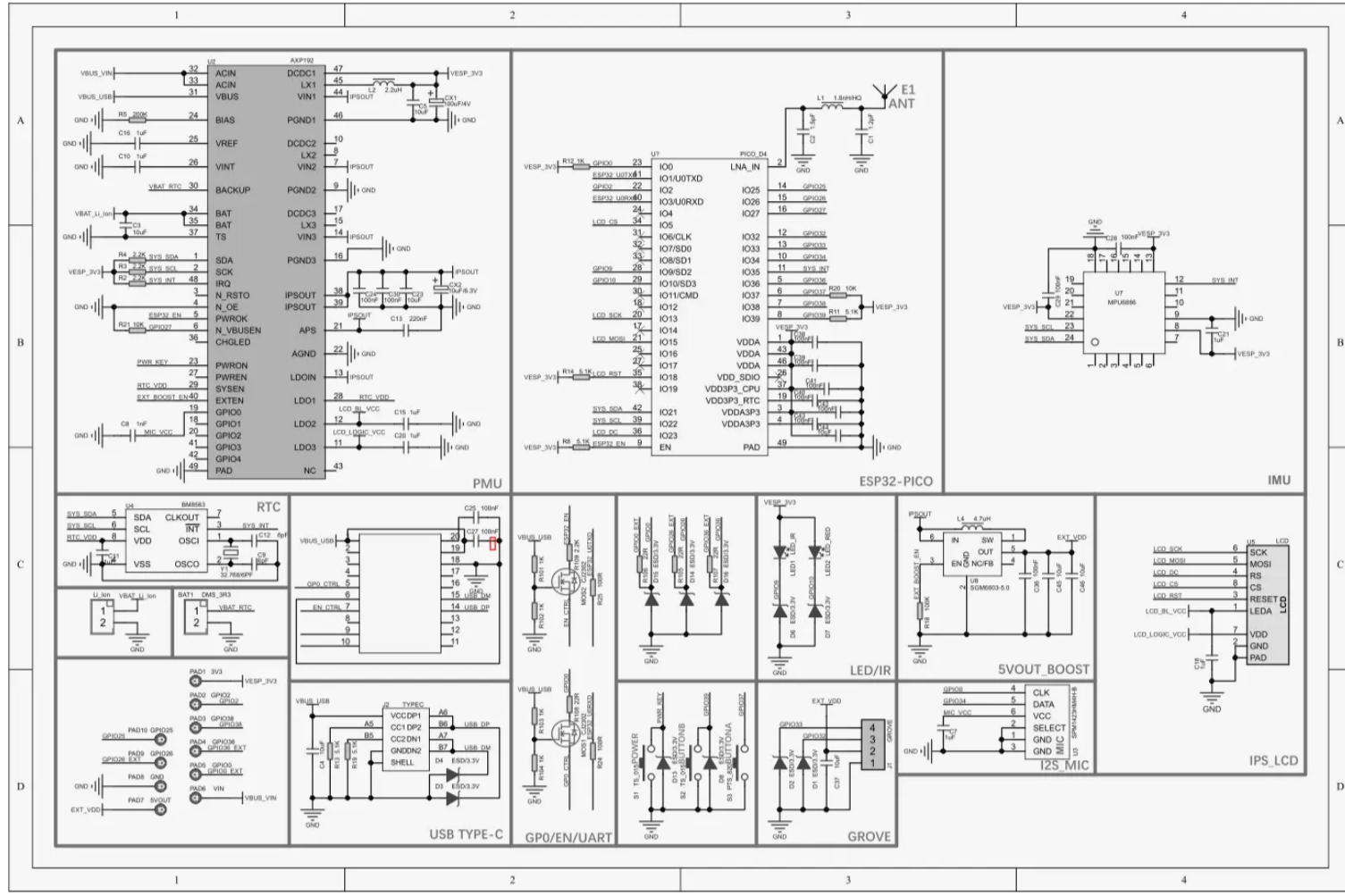

[PDF Download](#)

PinMap

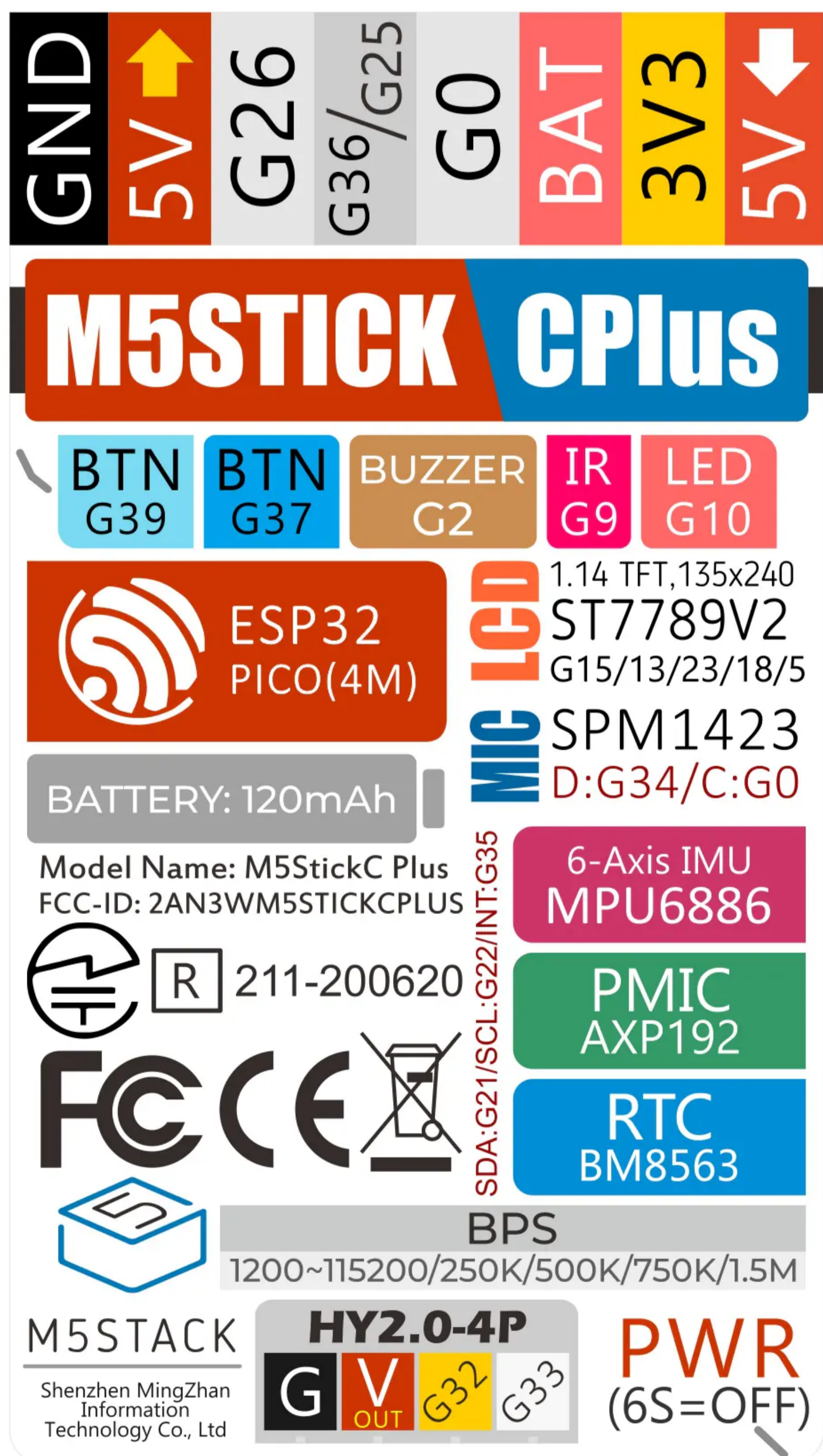

Power structure block diagram



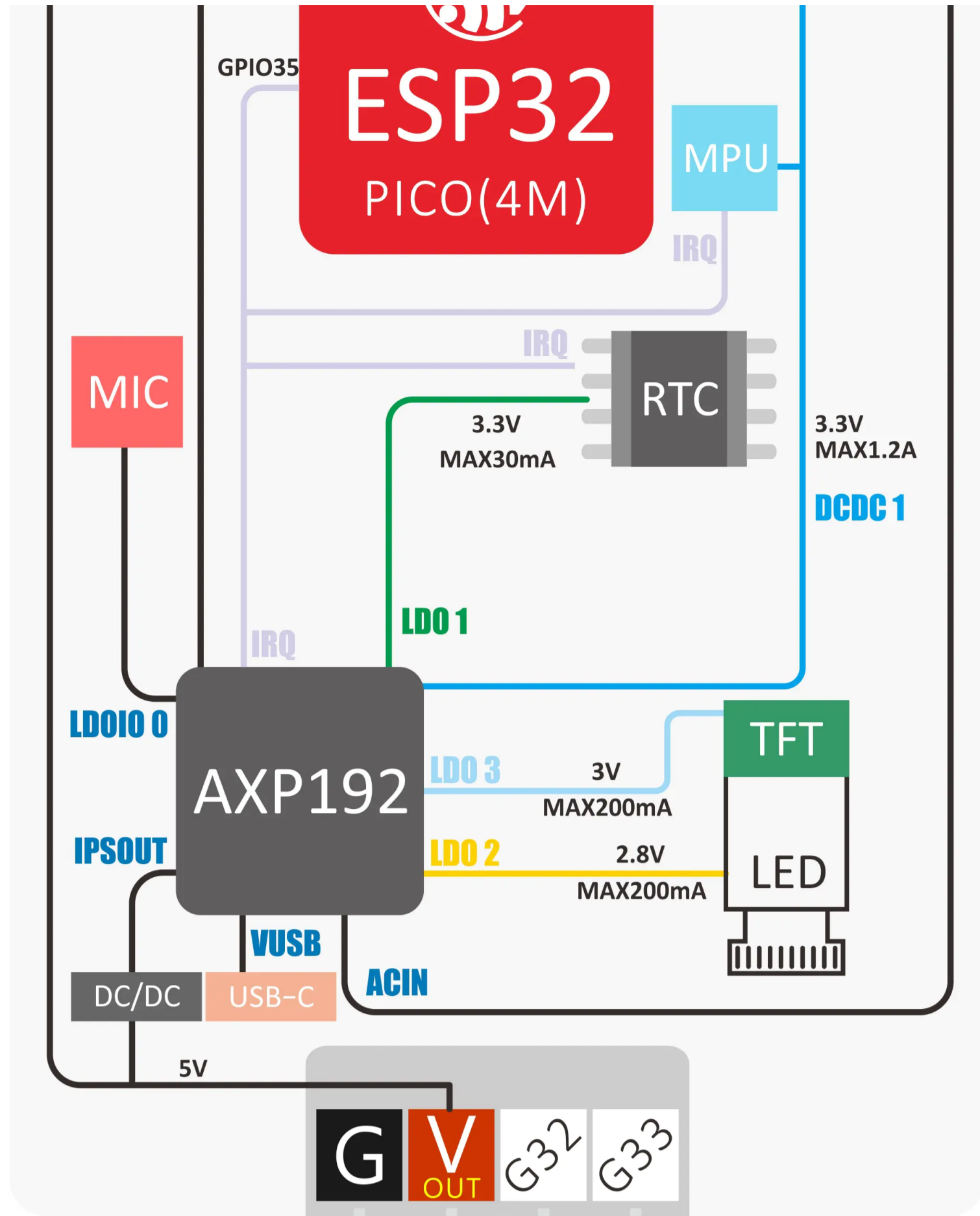

RED LED & IR Transmitter & BUTTON A & BUTTON B

ESP32	GPIO10	GPIO9	GPIO37	GPIO39	GPIO2
RED LED	LED Pin				
IR Transmitter		Transmitter Pin			
BUTTON A			Button Pin		
BUTTON B				Button Pin	
Buzzer					Buzzer Pin

TFT LCD

Driver IC: ST7789v2

Resolution: 135 * 240

ESP32	GPIO15	GPIO13	GPIO23	GPIO18	GPIO5
TFT LCD	TFT_MOSI	TFT_CLK	TFT_DC	TFT_RST	TFT_CS

GROVE PORT

ESP32	GPIO33	GPIO32	5V	GND
GROVE port	SCL	SDA	5V	GND

MIC (SPM1423)

ESP32	GPIO0	GPIO34
MICPHONE	CLK	DATA

6-Axis posture sensor (MPU6886) & power management IC (AXP192)

ESP32	GPIO22	GPIO21
6-Axis IMU sensor	SCL	SDA
Power management IC	SCL	SDA

AXP192

Microphone	RTC	TFT backlight	TFT IC	ESP32/3.3V MPU6886	5V GROVE
LDOio0	LDO1	LDO2	LDO3	DC-DC1	IPSOUT

Related Link

- **datasheet**

- [ESP32-PICO](#)
- [ST7789v2](#)
- [BM8563](#)
- [MPU6886](#)
- [AXP192](#)
- [SPM1423](#)

- **API**

- [Arduino API](#)

- **Arduino Library**

- [M5StickC_PLUS Library](#)

| Example

Arduino

- [M5StickC Plus factory test code](#)