

# MAT-WDB-DA-RM-2-0203-1m Series

2 dBi at 2.4 GHz or 3 dBi at 5 GHz, RP-SMA-type(male), 2x2 MIMO, dual-band desktop antennas with 1 m cables



## Features and Benefits

- Small size for easy installation
- Desktop mount
- RP-SMA-type (male) connector

## Introduction

The MAT-WDB-DA-RM-2-0203-1m antenna is a compact MIMO 2x2 dual-band desktop antenna with a RP-SMA-type (male) connector. The antenna can be used in both the 2.4 GHz and 5 GHz frequencies, provides an antenna gain of 2/3 dBi, and comes with a 1-m cable.

## Field Patterns

### Port 1 Frequency: 2.4 GHz

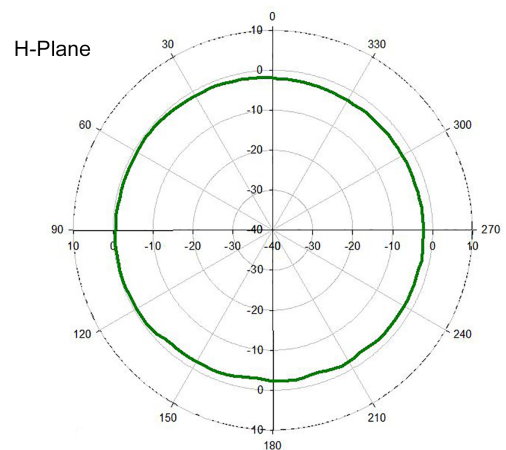
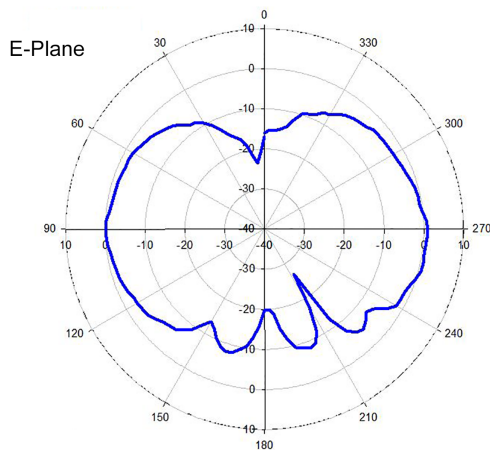

### Port 2 Frequency: 2.4 GHz

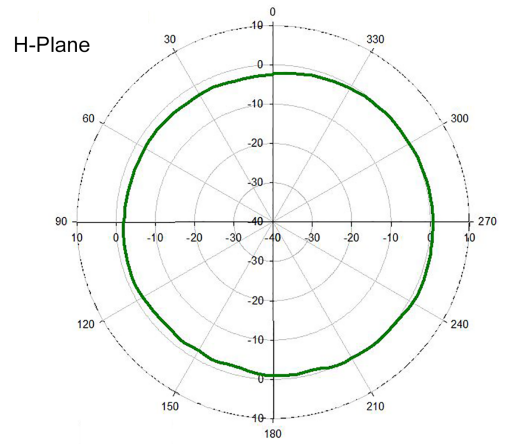
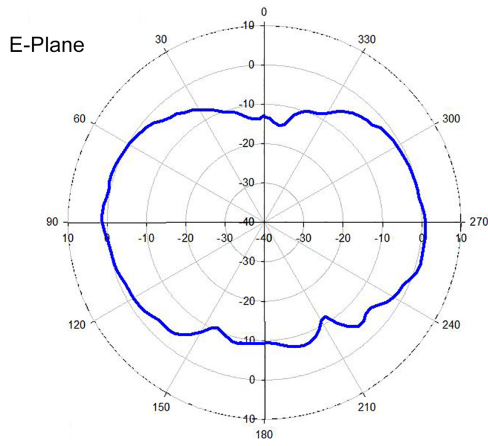

### Port 1 Frequency: 5 GHz

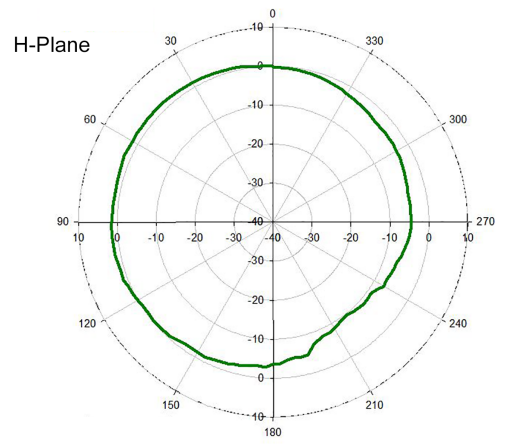
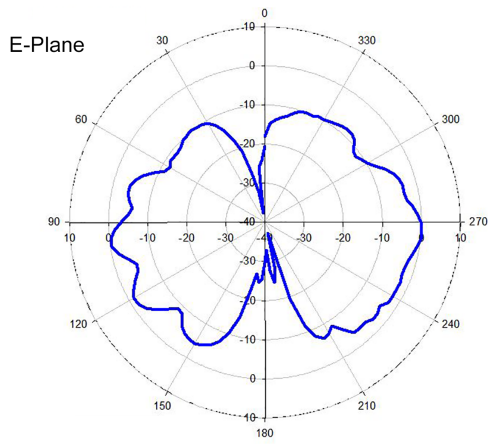

### Port 2 Frequency: 5 GHz

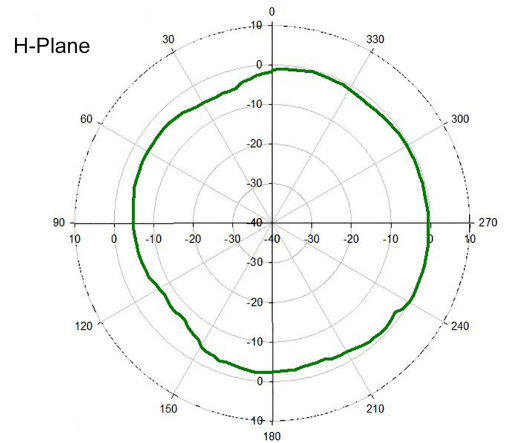
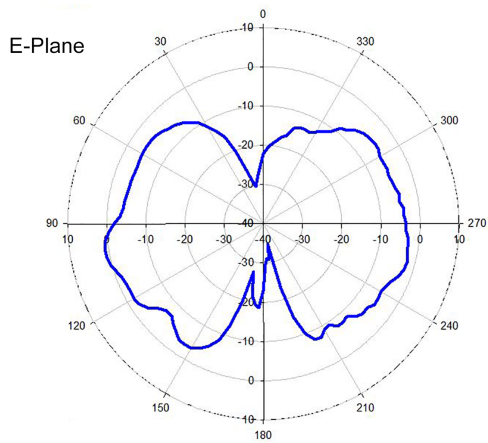

## Specifications

### Antenna Characteristics

Frequency	2.4 to 2.5, 4.9 to 5.85 GHz
Antenna Type	MIMO 2x2, Omni-directional
Typical Antenna Gain	2/3 dBi
Connector	RP-SMA (male)
Impedance	50 ohms

Polarization	Linear, Vertical
HPBW/Horizontal	360/114°
HPBW/Vertical	75/54°
V.S.W.R.	2:1 max.
Power Handling	2 W (max.)

#### Physical Characteristics

Weight	156 g (0.34 lb)
Length (including RF cable)	194.3 mm (7.65 in)
IP Rating	IP55
Radome Color	Black
Radome Material	PC-1250G
Installation	Desktop Mount
Cable	RG-174
Cable Length	1 m

#### Environmental Limits

Operating Temperature	-40 to 75°C (-40 to 167°F)
Storage Temperature (package included)	-40 to 75°C (-40 to 167°F)
Ambient Relative Humidity	5 to 95% (30°C, non-condensing)

#### Warranty

Warranty Period	1 year
Details	See <a href="http://www.moxa.com/warranty">www.moxa.com/warranty</a>

## Dimensions

Unit: mm

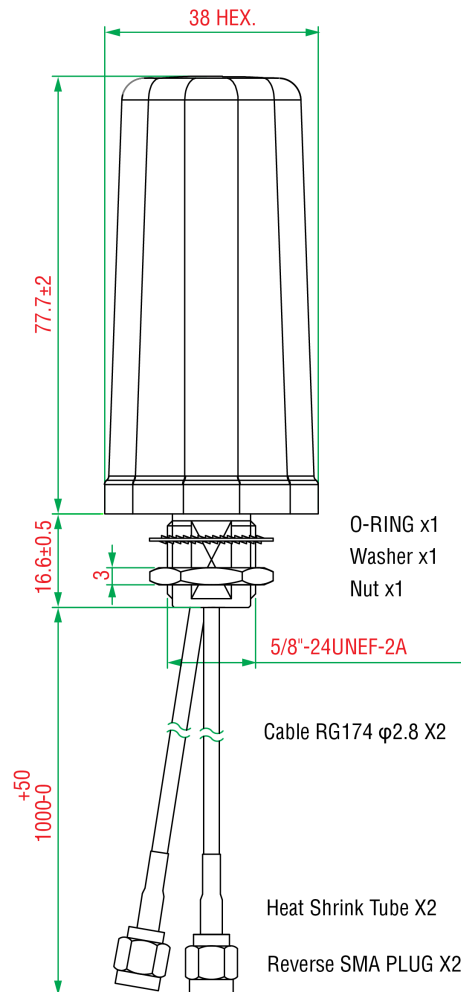

## Ordering Information

Model Name	Frequency	Antenna Type	Antenna Gain	Connector
MAT-WDB-DA-RM-2-0203-1m	2.4 to 2.5, 4.9 to 5.85 GHz	MIMO 2x2, Omni-directional	2/3 dBi	RP-SMA (male)

© Moxa Inc. All rights reserved. Updated Jul 15, 2021.

This document and any portion thereof may not be reproduced or used in any manner whatsoever without the express written permission of Moxa Inc. Product specifications subject to change without notice. Visit our website for the most up-to-date product information.