

Reference Specification

Leaded MLCC for General Purpose
RDE Series

Product specifications in this catalog are as of Mar. 2022, and are subject to change or obsolescence without notice.
Please consult the approval sheet before ordering. Please read rating and Cautions first.

⚠ CAUTION**1. OPERATING VOLTAGE**

When DC-rated capacitors are to be used in AC or ripple current circuits, be sure to maintain the V_{p-p} value of the applied voltage or the V_{o-p} which contains DC bias within the rated voltage range. When the voltage is started to apply to the circuit or it is stopped applying, the irregular voltage may be generated for a transit period because of resonance or switching. Be sure to use a capacitor within rated voltage containing these irregular voltage.

When DC-rated capacitors are to be used in input circuits from commercial power source (AC filter), be sure to use Safety Recognized Capacitors because various regulations on withstand voltage or impulse withstand established for each equipment should be taken into considerations.

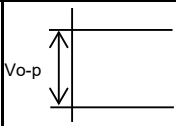
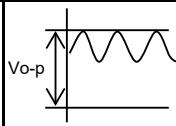
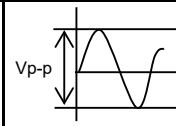
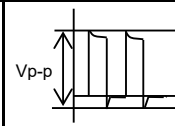
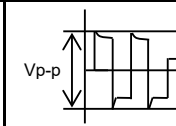
Voltage	DC Voltage	DC+AC Voltage	AC Voltage	Pulse Voltage(1)	Pulse Voltage(2)
Positional Measurement					

2. OPERATING TEMPERATURE AND SELF-GENERATED HEAT

Keep the surface temperature of a capacitor below the upper limit of its rated operating temperature range. Be sure to take into account the heat generated by the capacitor itself.

When the capacitor is used in a high-frequency current, pulse current or the like, it may have the self-generated heat due to dielectric-loss. In case of Class 2 capacitors (Temp.Char. : X7R,X7S,X8L, etc.), applied voltage should be the load such as self-generated heat is within 20 °C on the condition of atmosphere temperature 25 °C. Please contact us if self-generated heat is occurred with Class 1 capacitors (Temp.Char. : C0G,U2J,X8G, etc.). When measuring, use a thermocouple of small thermal capacity-K of $\Phi 0.1\text{mm}$ and be in the condition where capacitor is not affected by radiant heat of other components and wind of surroundings. Excessive heat may lead to deterioration of the capacitor's characteristics and reliability.

3. FAIL-SAFE

Be sure to provide an appropriate fail-safe function on your product to prevent a second damage that may be caused by the abnormal function or the failure of our product.

4. OPERATING AND STORAGE ENVIRONMENT

The insulating coating of capacitors does not form a perfect seal; therefore, do not use or store capacitors in a corrosive atmosphere, especially where chloride gas, sulfide gas, acid, alkali, salt or the like are present. And avoid exposure to moisture. Before cleaning, bonding, or molding this product, verify that these processes do not affect product quality by testing the performance of a cleaned, bonded or molded product in the intended equipment. Store the capacitors where the temperature and relative humidity do not exceed 5 to 40 °C and 20 to 70%. Use capacitors within 6 months.

5. VIBRATION AND IMPACT

Do not expose a capacitor or its leads to excessive shock or vibration during use.

6. SOLDERING

When soldering this product to a PCB/PWB, do not exceed the solder heat resistance specification of the capacitor. Subjecting this product to excessive heating could melt the internal junction solder and may result in thermal shocks that can crack the ceramic element.

7. BONDING AND RESIN MOLDING, RESIN COAT

In case of bonding, molding or coating this product, verify that these processes do not affect the quality of capacitor by testing the performance of a bonded or molded product in the intended equipment.

In case of the amount of applications, dryness / hardening conditions of adhesives and molding resins containing organic solvents (ethyl acetate, methyl ethyl ketone, toluene, etc.) are unsuitable, the outer coating resin of a capacitor is damaged by the organic solvents and it may result, worst case, in a short circuit.

The variation in thickness of adhesive or molding resin may cause a outer coating resin cracking and/or ceramic element cracking of a capacitor in a temperature cycling.

8. TREATMENT AFTER BONDING AND RESIN MOLDING, RESIN COAT

When the outer coating is hot (over 100 °C) after soldering, it becomes soft and fragile.

So please be careful not to give it mechanical stress.

Failure to follow the above cautions may result, worst case, in a short circuit and cause fuming or partial dispersion when the product is used.

9. LIMITATION OF APPLICATIONS

Please contact us before using our products for the applications listed below which require especially high reliability for the prevention of defects which might directly cause damage to the third party's life, body or property.

1. Aircraft equipment
2. Aerospace equipment
3. Undersea equipment
4. Power plant control equipment
5. Medical equipment
6. Transportation equipment (vehicles, trains, ships, etc.)
7. Traffic signal equipment
8. Disaster prevention / crime prevention equipment
9. Data-processing equipment exerting influence on public
10. Application of similar complexity and/or reliability requirements to the applications listed in the above.

NOTICE

1. CLEANING (ULTRASONIC CLEANING)

To perform ultrasonic cleaning, observe the following conditions.

Rinse bath capacity : Output of 20 watts per liter or less.

Rinsing time : 5 min maximum.

Do not vibrate the PCB/PWB directly.

Excessive ultrasonic cleaning may lead to fatigue destruction of the lead wires.

2. SOLDERING AND MOUNTING

Insertion of the Lead Wire

- When soldering, insert the lead wire into the PCB without mechanically stressing the lead wire.
- Insert the lead wire into the PCB with a distance appropriate to the lead space.

3. CAPACITANCE CHANGE OF CAPACITORS

- Class 2 capacitors (Temp.Char. : X7R,X7S,X8L etc.)

Class 2 capacitors an aging characteristic, whereby the capacitor continually decreases its capacitance slightly if the capacitor leaves for a long time. Moreover, capacitance might change greatly depending on a surrounding temperature or an applied voltage. So, it is not likely to be able to use for the time constant circuit.

Please contact us if you need a detail information.

NOTE

1. Please make sure that your product has been evaluated in view of your specifications with our product being mounted to your product.
2. You are requested not to use our product deviating from this specification.

1. Application

This product specification is applied to Leaded MLCC RDE series used for General Electronic equipment.

Do not use these products in any automotive power train or safety equipment including battery chargers for electric vehicles and plug-in hybrids.

2. Rating

• Part Number Configuration

ex.)	RDE	5C	1H	1R0	C	0	P1	H03	B
	Series	Temperature Characteristics	Rated Voltage	Capacitance	Capacitance Tolerance	Dimension (LxW)	Lead Style	Individual Specification	Package

• Temperature Characteristics

Code	Temp. Char.	Temp. Range	Temp.coef.	Standard Temp.	Operating Temp. Range
5C	C0G (EIA code)	-55~25°C	0+30/-72ppm/°C	25°C	-55~125°C
		25~125°C	0+/-30ppm/°C		

• Rated Voltage

Code	Rated voltage
1H	DC50V
2A	DC100V

• Capacitance

The first two digits denote significant figures ; the last digit denotes the multiplier of 10 in pF.

If there is a decimal point, it is expressed by the capital letter "R". In this case, all figures are significant digits.

ex.) In case of 102.

$$10 \times 10^2 = 1000 \text{pF}$$

In case of 1R0.

1.0pF

• Capacitance Tolerance

Code	Capacitance Tolerance
C	+/-0.25pF
D	+/-0.5pF
J	+/-5%

• Dimension (LxW)

Please refer to [Part number list].

• Lead Style

*Lead wire is "solder coated CP wire".

Code	Lead Style	Lead spacing (mm)
K1	Inside crimp type	5.0+/-0.8
M1	Inside crimp taping type	5.0+0.6/-0.2
P1	Outside crimp type	2.5+/-0.8
S1	Outside crimp taping type	2.5+0.4/-0.2

• Individual Specification

Murata's control code.

Please refer to [Part number list].



• Package

Code	Package
A	Taping type of Ammo
B	Bulk type

3. Marking

- Temp. char. : Letter code : A (C0G Char.)
- Capacitance : Actual numbers (Less than 100pF)
3 digit numbers (100pF and over)
- Capacitance tolerance : Code
- Rated voltage : Letter code : 5 (DC50V. Except dimension code : 0,1)
Letter code : 1 (DC100V. Except dimension code : 0,1)
- Company name code : Abbreviation :  (Except dimension code : 0,1)

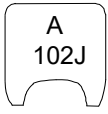
(Ex.)

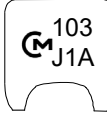
Rated voltage Dimension code	DC50V	DC100V
	0,1	
2		

4. Part number list

- Outside Crimp
(Lead Style : P1)

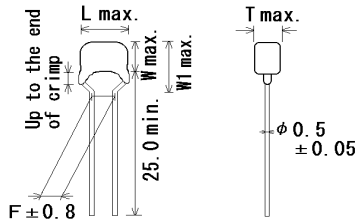

Unit : mm

Customer Part Number	Murata Part Number	T.C.	DC Rated Volt. (V)	Cap.	Cap. Tol.	Dimension (mm)					Dimension (LxW) Lead Style	Pack qty. (pcs)
						L	W	W1	F	T		
	RDE5C1H1R0C0P1H03B	C0G	50	1pF	±0.25pF	5.0	3.5	6.0	2.5	2.5	0P1	500
	RDE5C1H2R0C0P1H03B	C0G	50	2pF	±0.25pF	5.0	3.5	6.0	2.5	2.5	0P1	500
	RDE5C1H3R0C0P1H03B	C0G	50	3pF	±0.25pF	5.0	3.5	6.0	2.5	2.5	0P1	500
	RDE5C1H4R0C0P1H03B	C0G	50	4pF	±0.25pF	5.0	3.5	6.0	2.5	2.5	0P1	500
	RDE5C1H5R0C0P1H03B	C0G	50	5pF	±0.25pF	5.0	3.5	6.0	2.5	2.5	0P1	500
	RDE5C1H6R0D0P1H03B	C0G	50	6pF	±0.5pF	5.0	3.5	6.0	2.5	2.5	0P1	500
	RDE5C1H7R0D0P1H03B	C0G	50	7pF	±0.5pF	5.0	3.5	6.0	2.5	2.5	0P1	500
	RDE5C1H8R0D0P1H03B	C0G	50	8pF	±0.5pF	5.0	3.5	6.0	2.5	2.5	0P1	500
	RDE5C1H9R0D0P1H03B	C0G	50	9pF	±0.5pF	5.0	3.5	6.0	2.5	2.5	0P1	500
	RDE5C1H100J0P1H03B	C0G	50	10pF	±5%	5.0	3.5	6.0	2.5	2.5	0P1	500
	RDE5C1H120J0P1H03B	C0G	50	12pF	±5%	5.0	3.5	6.0	2.5	2.5	0P1	500
	RDE5C1H150J0P1H03B	C0G	50	15pF	±5%	5.0	3.5	6.0	2.5	2.5	0P1	500
	RDE5C1H180J0P1H03B	C0G	50	18pF	±5%	5.0	3.5	6.0	2.5	2.5	0P1	500
	RDE5C1H220J0P1H03B	C0G	50	22pF	±5%	5.0	3.5	6.0	2.5	2.5	0P1	500
	RDE5C1H270J0P1H03B	C0G	50	27pF	±5%	5.0	3.5	6.0	2.5	2.5	0P1	500
	RDE5C1H330J0P1H03B	C0G	50	33pF	±5%	5.0	3.5	6.0	2.5	2.5	0P1	500
	RDE5C1H390J0P1H03B	C0G	50	39pF	±5%	5.0	3.5	6.0	2.5	2.5	0P1	500
	RDE5C1H470J0P1H03B	C0G	50	47pF	±5%	5.0	3.5	6.0	2.5	2.5	0P1	500
	RDE5C1H560J0P1H03B	C0G	50	56pF	±5%	5.0	3.5	6.0	2.5	2.5	0P1	500
	RDE5C1H680J0P1H03B	C0G	50	68pF	±5%	5.0	3.5	6.0	2.5	2.5	0P1	500
	RDE5C1H820J0P1H03B	C0G	50	82pF	±5%	5.0	3.5	6.0	2.5	2.5	0P1	500
	RDE5C1H101J0P1H03B	C0G	50	100pF	±5%	5.0	3.5	6.0	2.5	2.5	0P1	500
	RDE5C1H121J0P1H03B	C0G	50	120pF	±5%	5.0	3.5	6.0	2.5	2.5	0P1	500
	RDE5C1H151J0P1H03B	C0G	50	150pF	±5%	5.0	3.5	6.0	2.5	2.5	0P1	500
	RDE5C1H181J0P1H03B	C0G	50	180pF	±5%	5.0	3.5	6.0	2.5	2.5	0P1	500
	RDE5C1H221J0P1H03B	C0G	50	220pF	±5%	5.0	3.5	6.0	2.5	2.5	0P1	500
	RDE5C1H271J0P1H03B	C0G	50	270pF	±5%	5.0	3.5	6.0	2.5	2.5	0P1	500
	RDE5C1H331J0P1H03B	C0G	50	330pF	±5%	5.0	3.5	6.0	2.5	2.5	0P1	500
	RDE5C1H391J0P1H03B	C0G	50	390pF	±5%	5.0	3.5	6.0	2.5	2.5	0P1	500
	RDE5C1H471J0P1H03B	C0G	50	470pF	±5%	5.0	3.5	6.0	2.5	2.5	0P1	500
	RDE5C1H561J0P1H03B	C0G	50	560pF	±5%	5.0	3.5	6.0	2.5	2.5	0P1	500
	RDE5C1H681J0P1H03B	C0G	50	680pF	±5%	5.0	3.5	6.0	2.5	2.5	0P1	500
	RDE5C1H821J0P1H03B	C0G	50	820pF	±5%	5.0	3.5	6.0	2.5	2.5	0P1	500
	RDE5C1H102J0P1H03B	C0G	50	1000pF	±5%	5.0	3.5	6.0	2.5	2.5	0P1	500
	RDE5C1H122J0P1H03B	C0G	50	1200pF	±5%	5.0	3.5	6.0	2.5	2.5	0P1	500
	RDE5C1H152J0P1H03B	C0G	50	1500pF	±5%	5.0	3.5	6.0	2.5	2.5	0P1	500
	RDE5C1H182J0P1H03B	C0G	50	1800pF	±5%	5.0	3.5	6.0	2.5	2.5	0P1	500
	RDE5C1H222J0P1H03B	C0G	50	2200pF	±5%	5.0	3.5	6.0	2.5	2.5	0P1	500
	RDE5C1H272J0P1H03B	C0G	50	2700pF	±5%	5.0	3.5	6.0	2.5	2.5	0P1	500
	RDE5C1H332J0P1H03B	C0G	50	3300pF	±5%	5.0	3.5	6.0	2.5	2.5	0P1	500

- Outside Crimp
(Lead Style : P1)

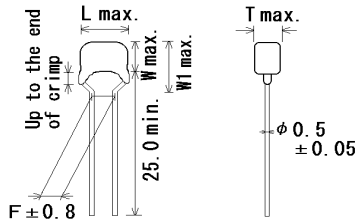

Unit : mm

Customer Part Number	Murata Part Number	T.C.	DC Rated Volt. (V)	Cap.	Cap. Tol.	Dimension (mm)					Dimension (LxW) Lead Style	Pack qty. (pcs)
						L	W	W1	F	T		
	RDE5C1H392J0P1H03B	C0G	50	3900pF	±5%	5.0	3.5	6.0	2.5	2.5	0P1	500
	RDE5C1H472J1P1H03B	C0G	50	4700pF	±5%	5.0	3.5	5.0	2.5	3.15	1P1	500
	RDE5C1H562J1P1H03B	C0G	50	5600pF	±5%	5.0	3.5	5.0	2.5	3.15	1P1	500
	RDE5C1H682J1P1H03B	C0G	50	6800pF	±5%	5.0	3.5	5.0	2.5	3.15	1P1	500
	RDE5C1H822J1P1H03B	C0G	50	8200pF	±5%	5.0	3.5	5.0	2.5	3.15	1P1	500
	RDE5C1H103J1P1H03B	C0G	50	10000pF	±5%	5.0	3.5	5.0	2.5	3.15	1P1	500
	RDE5C1H123J1P1H03B	C0G	50	12000pF	±5%	5.0	3.5	5.0	2.5	3.15	1P1	500
	RDE5C1H153J1P1H03B	C0G	50	15000pF	±5%	5.0	3.5	5.0	2.5	3.15	1P1	500
	RDE5C1H183J1P1H03B	C0G	50	18000pF	±5%	5.0	3.5	5.0	2.5	3.15	1P1	500
	RDE5C1H223J1P1H03B	C0G	50	22000pF	±5%	5.0	3.5	5.0	2.5	3.15	1P1	500
	RDE5C1H273J2P1H03B	C0G	50	27000pF	±5%	5.5	4.0	6.0	2.5	3.15	2P1	500
	RDE5C1H333J2P1H03B	C0G	50	33000pF	±5%	5.5	4.0	6.0	2.5	3.15	2P1	500
	RDE5C1H393J2P1H03B	C0G	50	39000pF	±5%	5.5	4.0	6.0	2.5	3.15	2P1	500
	RDE5C1H473J2P1H03B	C0G	50	47000pF	±5%	5.5	4.0	6.0	2.5	3.15	2P1	500
	RDE5C1H563J2P1H03B	C0G	50	56000pF	±5%	5.5	4.0	6.0	2.5	3.15	2P1	500
	RDE5C1H683J2P1H03B	C0G	50	68000pF	±5%	5.5	4.0	6.0	2.5	3.15	2P1	500
	RDE5C1H823J2P1H03B	C0G	50	82000pF	±5%	5.5	4.0	6.0	2.5	3.15	2P1	500
	RDE5C1H104J2P1H03B	C0G	50	0.1μF	±5%	5.5	4.0	6.0	2.5	3.15	2P1	500
	RDE5C2A1R0C0P1H03B	C0G	100	1pF	±0.25pF	5.0	3.5	6.0	2.5	2.5	0P1	500
	RDE5C2A2R0C0P1H03B	C0G	100	2pF	±0.25pF	5.0	3.5	6.0	2.5	2.5	0P1	500
	RDE5C2A3R0C0P1H03B	C0G	100	3pF	±0.25pF	5.0	3.5	6.0	2.5	2.5	0P1	500
	RDE5C2A4R0C0P1H03B	C0G	100	4pF	±0.25pF	5.0	3.5	6.0	2.5	2.5	0P1	500
	RDE5C2A5R0C0P1H03B	C0G	100	5pF	±0.25pF	5.0	3.5	6.0	2.5	2.5	0P1	500
	RDE5C2A6R0D0P1H03B	C0G	100	6pF	±0.5pF	5.0	3.5	6.0	2.5	2.5	0P1	500
	RDE5C2A7R0D0P1H03B	C0G	100	7pF	±0.5pF	5.0	3.5	6.0	2.5	2.5	0P1	500
	RDE5C2A8R0D0P1H03B	C0G	100	8pF	±0.5pF	5.0	3.5	6.0	2.5	2.5	0P1	500
	RDE5C2A9R0D0P1H03B	C0G	100	9pF	±0.5pF	5.0	3.5	6.0	2.5	2.5	0P1	500
	RDE5C2A100J0P1H03B	C0G	100	10pF	±5%	5.0	3.5	6.0	2.5	2.5	0P1	500
	RDE5C2A120J0P1H03B	C0G	100	12pF	±5%	5.0	3.5	6.0	2.5	2.5	0P1	500
	RDE5C2A150J0P1H03B	C0G	100	15pF	±5%	5.0	3.5	6.0	2.5	2.5	0P1	500
	RDE5C2A180J0P1H03B	C0G	100	18pF	±5%	5.0	3.5	6.0	2.5	2.5	0P1	500
	RDE5C2A220J0P1H03B	C0G	100	22pF	±5%	5.0	3.5	6.0	2.5	2.5	0P1	500
	RDE5C2A270J0P1H03B	C0G	100	27pF	±5%	5.0	3.5	6.0	2.5	2.5	0P1	500
	RDE5C2A330J0P1H03B	C0G	100	33pF	±5%	5.0	3.5	6.0	2.5	2.5	0P1	500
	RDE5C2A390J0P1H03B	C0G	100	39pF	±5%	5.0	3.5	6.0	2.5	2.5	0P1	500
	RDE5C2A470J0P1H03B	C0G	100	47pF	±5%	5.0	3.5	6.0	2.5	2.5	0P1	500
	RDE5C2A560J0P1H03B	C0G	100	56pF	±5%	5.0	3.5	6.0	2.5	2.5	0P1	500
	RDE5C2A680J0P1H03B	C0G	100	68pF	±5%	5.0	3.5	6.0	2.5	2.5	0P1	500
	RDE5C2A820J0P1H03B	C0G	100	82pF	±5%	5.0	3.5	6.0	2.5	2.5	0P1	500
	RDE5C2A101J0P1H03B	C0G	100	100pF	±5%	5.0	3.5	6.0	2.5	2.5	0P1	500

- Outside Crimp
(Lead Style : P1)

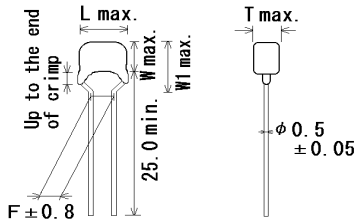

- Inside Crimp
(Lead Style : K*)

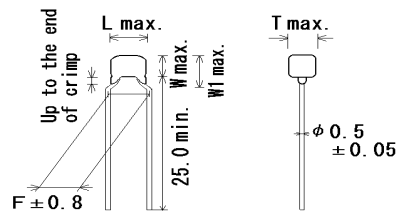

Unit : mm

Customer Part Number	Murata Part Number	T.C.	DC Rated Volt. (V)	Cap.	Cap. Tol.	Dimension (mm)					Dimension (LxW) Lead Style	Pack qty. (pcs)
						L	W	W1	F	T		
	RDE5C2A121J0P1H03B	C0G	100	120pF	±5%	5.0	3.5	6.0	2.5	2.5	0P1	500
	RDE5C2A151J0P1H03B	C0G	100	150pF	±5%	5.0	3.5	6.0	2.5	2.5	0P1	500
	RDE5C2A181J0P1H03B	C0G	100	180pF	±5%	5.0	3.5	6.0	2.5	2.5	0P1	500
	RDE5C2A221J0P1H03B	C0G	100	220pF	±5%	5.0	3.5	6.0	2.5	2.5	0P1	500
	RDE5C2A271J0P1H03B	C0G	100	270pF	±5%	5.0	3.5	6.0	2.5	2.5	0P1	500
	RDE5C2A331J0P1H03B	C0G	100	330pF	±5%	5.0	3.5	6.0	2.5	2.5	0P1	500
	RDE5C2A391J0P1H03B	C0G	100	390pF	±5%	5.0	3.5	6.0	2.5	2.5	0P1	500
	RDE5C2A471J0P1H03B	C0G	100	470pF	±5%	5.0	3.5	6.0	2.5	2.5	0P1	500
	RDE5C2A561J0P1H03B	C0G	100	560pF	±5%	5.0	3.5	6.0	2.5	2.5	0P1	500
	RDE5C2A681J0P1H03B	C0G	100	680pF	±5%	5.0	3.5	6.0	2.5	2.5	0P1	500
	RDE5C2A821J0P1H03B	C0G	100	820pF	±5%	5.0	3.5	6.0	2.5	2.5	0P1	500
	RDE5C2A102J0P1H03B	C0G	100	1000pF	±5%	5.0	3.5	6.0	2.5	2.5	0P1	500
	RDE5C2A122J0P1H03B	C0G	100	1200pF	±5%	5.0	3.5	6.0	2.5	2.5	0P1	500
	RDE5C2A152J0P1H03B	C0G	100	1500pF	±5%	5.0	3.5	6.0	2.5	2.5	0P1	500
	RDE5C2A182J1P1H03B	C0G	100	1800pF	±5%	5.0	3.5	5.0	2.5	3.15	1P1	500
	RDE5C2A222J1P1H03B	C0G	100	2200pF	±5%	5.0	3.5	5.0	2.5	3.15	1P1	500
	RDE5C2A272J1P1H03B	C0G	100	2700pF	±5%	5.0	3.5	5.0	2.5	3.15	1P1	500
	RDE5C2A332J1P1H03B	C0G	100	3300pF	±5%	5.0	3.5	5.0	2.5	3.15	1P1	500
	RDE5C2A392J2P1H03B	C0G	100	3900pF	±5%	5.5	4.0	6.0	2.5	3.15	2P1	500
	RDE5C2A472J2P1H03B	C0G	100	4700pF	±5%	5.5	4.0	6.0	2.5	3.15	2P1	500
	RDE5C2A562J2P1H03B	C0G	100	5600pF	±5%	5.5	4.0	6.0	2.5	3.15	2P1	500
	RDE5C2A682J2P1H03B	C0G	100	6800pF	±5%	5.5	4.0	6.0	2.5	3.15	2P1	500
	RDE5C2A822J2P1H03B	C0G	100	8200pF	±5%	5.5	4.0	6.0	2.5	3.15	2P1	500
	RDE5C2A103J2P1H03B	C0G	100	10000pF	±5%	5.5	4.0	6.0	2.5	3.15	2P1	500
	RDE5C2A123J2P1H03B	C0G	100	12000pF	±5%	5.5	4.0	6.0	2.5	3.15	2P1	500
	RDE5C2A153J2P1H03B	C0G	100	15000pF	±5%	5.5	4.0	6.0	2.5	3.15	2P1	500
	RDE5C2A183J2P1H03B	C0G	100	18000pF	±5%	5.5	4.0	6.0	2.5	3.15	2P1	500
	RDE5C2A223J2P1H03B	C0G	100	22000pF	±5%	5.5	4.0	6.0	2.5	3.15	2P1	500
	RDE5C1H1R0C0K1H03B	C0G	50	1pF	±0.25pF	4.0	3.5	6.0	5.0	2.5	0K1	500
	RDE5C1H2R0C0K1H03B	C0G	50	2pF	±0.25pF	4.0	3.5	6.0	5.0	2.5	0K1	500
	RDE5C1H3R0C0K1H03B	C0G	50	3pF	±0.25pF	4.0	3.5	6.0	5.0	2.5	0K1	500
	RDE5C1H4R0C0K1H03B	C0G	50	4pF	±0.25pF	4.0	3.5	6.0	5.0	2.5	0K1	500
	RDE5C1H5R0C0K1H03B	C0G	50	5pF	±0.25pF	4.0	3.5	6.0	5.0	2.5	0K1	500
	RDE5C1H6R0D0K1H03B	C0G	50	6pF	±0.5pF	4.0	3.5	6.0	5.0	2.5	0K1	500
	RDE5C1H7R0D0K1H03B	C0G	50	7pF	±0.5pF	4.0	3.5	6.0	5.0	2.5	0K1	500
	RDE5C1H8R0D0K1H03B	C0G	50	8pF	±0.5pF	4.0	3.5	6.0	5.0	2.5	0K1	500
	RDE5C1H9R0D0K1H03B	C0G	50	9pF	±0.5pF	4.0	3.5	6.0	5.0	2.5	0K1	500
	RDE5C1H10J0K1H03B	C0G	50	10pF	±5%	4.0	3.5	6.0	5.0	2.5	0K1	500
	RDE5C1H12J0K1H03B	C0G	50	12pF	±5%	4.0	3.5	6.0	5.0	2.5	0K1	500
	RDE5C1H15J0K1H03B	C0G	50	15pF	±5%	4.0	3.5	6.0	5.0	2.5	0K1	500

- Inside Crimp
(Lead Style : K*)

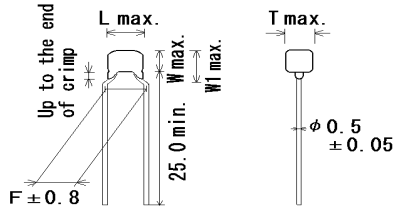

Unit : mm

Customer Part Number	Murata Part Number	T.C.	DC Rated Volt. (V)	Cap.	Cap. Tol.	Dimension (mm)					Dimension (LxW) Lead Style	Pack qty. (pcs)
						L	W	W1	F	T		
	RDE5C1H180J0K1H03B	C0G	50	18pF	±5%	4.0	3.5	6.0	5.0	2.5	0K1	500
	RDE5C1H220J0K1H03B	C0G	50	22pF	±5%	4.0	3.5	6.0	5.0	2.5	0K1	500
	RDE5C1H270J0K1H03B	C0G	50	27pF	±5%	4.0	3.5	6.0	5.0	2.5	0K1	500
	RDE5C1H330J0K1H03B	C0G	50	33pF	±5%	4.0	3.5	6.0	5.0	2.5	0K1	500
	RDE5C1H390J0K1H03B	C0G	50	39pF	±5%	4.0	3.5	6.0	5.0	2.5	0K1	500
	RDE5C1H470J0K1H03B	C0G	50	47pF	±5%	4.0	3.5	6.0	5.0	2.5	0K1	500
	RDE5C1H560J0K1H03B	C0G	50	56pF	±5%	4.0	3.5	6.0	5.0	2.5	0K1	500
	RDE5C1H680J0K1H03B	C0G	50	68pF	±5%	4.0	3.5	6.0	5.0	2.5	0K1	500
	RDE5C1H820J0K1H03B	C0G	50	82pF	±5%	4.0	3.5	6.0	5.0	2.5	0K1	500
	RDE5C1H101J0K1H03B	C0G	50	100pF	±5%	4.0	3.5	6.0	5.0	2.5	0K1	500
	RDE5C1H121J0K1H03B	C0G	50	120pF	±5%	4.0	3.5	6.0	5.0	2.5	0K1	500
	RDE5C1H151J0K1H03B	C0G	50	150pF	±5%	4.0	3.5	6.0	5.0	2.5	0K1	500
	RDE5C1H181J0K1H03B	C0G	50	180pF	±5%	4.0	3.5	6.0	5.0	2.5	0K1	500
	RDE5C1H221J0K1H03B	C0G	50	220pF	±5%	4.0	3.5	6.0	5.0	2.5	0K1	500
	RDE5C1H271J0K1H03B	C0G	50	270pF	±5%	4.0	3.5	6.0	5.0	2.5	0K1	500
	RDE5C1H331J0K1H03B	C0G	50	330pF	±5%	4.0	3.5	6.0	5.0	2.5	0K1	500
	RDE5C1H391J0K1H03B	C0G	50	390pF	±5%	4.0	3.5	6.0	5.0	2.5	0K1	500
	RDE5C1H471J0K1H03B	C0G	50	470pF	±5%	4.0	3.5	6.0	5.0	2.5	0K1	500
	RDE5C1H561J0K1H03B	C0G	50	560pF	±5%	4.0	3.5	6.0	5.0	2.5	0K1	500
	RDE5C1H681J0K1H03B	C0G	50	680pF	±5%	4.0	3.5	6.0	5.0	2.5	0K1	500
	RDE5C1H821J0K1H03B	C0G	50	820pF	±5%	4.0	3.5	6.0	5.0	2.5	0K1	500
	RDE5C1H102J0K1H03B	C0G	50	1000pF	±5%	4.0	3.5	6.0	5.0	2.5	0K1	500
	RDE5C1H122J0K1H03B	C0G	50	1200pF	±5%	4.0	3.5	6.0	5.0	2.5	0K1	500
	RDE5C1H152J0K1H03B	C0G	50	1500pF	±5%	4.0	3.5	6.0	5.0	2.5	0K1	500
	RDE5C1H182J0K1H03B	C0G	50	1800pF	±5%	4.0	3.5	6.0	5.0	2.5	0K1	500
	RDE5C1H222J0K1H03B	C0G	50	2200pF	±5%	4.0	3.5	6.0	5.0	2.5	0K1	500
	RDE5C1H272J0K1H03B	C0G	50	2700pF	±5%	4.0	3.5	6.0	5.0	2.5	0K1	500
	RDE5C1H332J0K1H03B	C0G	50	3300pF	±5%	4.0	3.5	6.0	5.0	2.5	0K1	500
	RDE5C1H392J0K1H03B	C0G	50	3900pF	±5%	4.0	3.5	6.0	5.0	2.5	0K1	500
	RDE5C1H472J1K1H03B	C0G	50	4700pF	±5%	4.5	3.5	5.0	5.0	3.15	1K1	500
	RDE5C1H562J1K1H03B	C0G	50	5600pF	±5%	4.5	3.5	5.0	5.0	3.15	1K1	500
	RDE5C1H682J1K1H03B	C0G	50	6800pF	±5%	4.5	3.5	5.0	5.0	3.15	1K1	500
	RDE5C1H822J1K1H03B	C0G	50	8200pF	±5%	4.5	3.5	5.0	5.0	3.15	1K1	500
	RDE5C1H103J1K1H03B	C0G	50	10000pF	±5%	4.5	3.5	5.0	5.0	3.15	1K1	500
	RDE5C1H123J1K1H03B	C0G	50	12000pF	±5%	4.5	3.5	5.0	5.0	3.15	1K1	500
	RDE5C1H153J1K1H03B	C0G	50	15000pF	±5%	4.5	3.5	5.0	5.0	3.15	1K1	500
	RDE5C1H183J1K1H03B	C0G	50	18000pF	±5%	4.5	3.5	5.0	5.0	3.15	1K1	500
	RDE5C1H223J1K1H03B	C0G	50	22000pF	±5%	4.5	3.5	5.0	5.0	3.15	1K1	500
	RDE5C1H273J2K1H03B	C0G	50	27000pF	±5%	5.5	4.0	6.0	5.0	3.15	2K1	500
	RDE5C1H333J2K1H03B	C0G	50	33000pF	±5%	5.5	4.0	6.0	5.0	3.15	2K1	500

- Inside Crimp
(Lead Style : K*)

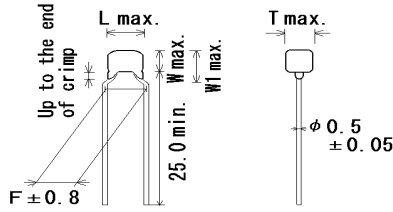

Unit : mm

Customer Part Number	Murata Part Number	T.C.	DC Rated Volt. (V)	Cap.	Cap. Tol.	Dimension (mm)					Dimension (LxW) Lead Style	Pack qty. (pcs)
						L	W	W1	F	T		
	RDE5C1H393J2K1H03B	C0G	50	39000pF	±5%	5.5	4.0	6.0	5.0	3.15	2K1	500
	RDE5C1H473J2K1H03B	C0G	50	47000pF	±5%	5.5	4.0	6.0	5.0	3.15	2K1	500
	RDE5C1H563J2K1H03B	C0G	50	56000pF	±5%	5.5	4.0	6.0	5.0	3.15	2K1	500
	RDE5C1H683J2K1H03B	C0G	50	68000pF	±5%	5.5	4.0	6.0	5.0	3.15	2K1	500
	RDE5C1H823J2K1H03B	C0G	50	82000pF	±5%	5.5	4.0	6.0	5.0	3.15	2K1	500
	RDE5C1H104J2K1H03B	C0G	50	0.1μF	±5%	5.5	4.0	6.0	5.0	3.15	2K1	500
	RDE5C2A1R0C0K1H03B	C0G	100	1pF	±0.25pF	4.0	3.5	6.0	5.0	2.5	0K1	500
	RDE5C2A2R0C0K1H03B	C0G	100	2pF	±0.25pF	4.0	3.5	6.0	5.0	2.5	0K1	500
	RDE5C2A3R0C0K1H03B	C0G	100	3pF	±0.25pF	4.0	3.5	6.0	5.0	2.5	0K1	500
	RDE5C2A4R0C0K1H03B	C0G	100	4pF	±0.25pF	4.0	3.5	6.0	5.0	2.5	0K1	500
	RDE5C2A5R0C0K1H03B	C0G	100	5pF	±0.25pF	4.0	3.5	6.0	5.0	2.5	0K1	500
	RDE5C2A6R0D0K1H03B	C0G	100	6pF	±0.5pF	4.0	3.5	6.0	5.0	2.5	0K1	500
	RDE5C2A7R0D0K1H03B	C0G	100	7pF	±0.5pF	4.0	3.5	6.0	5.0	2.5	0K1	500
	RDE5C2A8R0D0K1H03B	C0G	100	8pF	±0.5pF	4.0	3.5	6.0	5.0	2.5	0K1	500
	RDE5C2A9R0D0K1H03B	C0G	100	9pF	±0.5pF	4.0	3.5	6.0	5.0	2.5	0K1	500
	RDE5C2A100J0K1H03B	C0G	100	10pF	±5%	4.0	3.5	6.0	5.0	2.5	0K1	500
	RDE5C2A120J0K1H03B	C0G	100	12pF	±5%	4.0	3.5	6.0	5.0	2.5	0K1	500
	RDE5C2A150J0K1H03B	C0G	100	15pF	±5%	4.0	3.5	6.0	5.0	2.5	0K1	500
	RDE5C2A180J0K1H03B	C0G	100	18pF	±5%	4.0	3.5	6.0	5.0	2.5	0K1	500
	RDE5C2A220J0K1H03B	C0G	100	22pF	±5%	4.0	3.5	6.0	5.0	2.5	0K1	500
	RDE5C2A270J0K1H03B	C0G	100	27pF	±5%	4.0	3.5	6.0	5.0	2.5	0K1	500
	RDE5C2A330J0K1H03B	C0G	100	33pF	±5%	4.0	3.5	6.0	5.0	2.5	0K1	500
	RDE5C2A390J0K1H03B	C0G	100	39pF	±5%	4.0	3.5	6.0	5.0	2.5	0K1	500
	RDE5C2A470J0K1H03B	C0G	100	47pF	±5%	4.0	3.5	6.0	5.0	2.5	0K1	500
	RDE5C2A560J0K1H03B	C0G	100	56pF	±5%	4.0	3.5	6.0	5.0	2.5	0K1	500
	RDE5C2A680J0K1H03B	C0G	100	68pF	±5%	4.0	3.5	6.0	5.0	2.5	0K1	500
	RDE5C2A820J0K1H03B	C0G	100	82pF	±5%	4.0	3.5	6.0	5.0	2.5	0K1	500
	RDE5C2A101J0K1H03B	C0G	100	100pF	±5%	4.0	3.5	6.0	5.0	2.5	0K1	500
	RDE5C2A121J0K1H03B	C0G	100	120pF	±5%	4.0	3.5	6.0	5.0	2.5	0K1	500
	RDE5C2A151J0K1H03B	C0G	100	150pF	±5%	4.0	3.5	6.0	5.0	2.5	0K1	500
	RDE5C2A181J0K1H03B	C0G	100	180pF	±5%	4.0	3.5	6.0	5.0	2.5	0K1	500
	RDE5C2A221J0K1H03B	C0G	100	220pF	±5%	4.0	3.5	6.0	5.0	2.5	0K1	500
	RDE5C2A271J0K1H03B	C0G	100	270pF	±5%	4.0	3.5	6.0	5.0	2.5	0K1	500
	RDE5C2A331J0K1H03B	C0G	100	330pF	±5%	4.0	3.5	6.0	5.0	2.5	0K1	500
	RDE5C2A391J0K1H03B	C0G	100	390pF	±5%	4.0	3.5	6.0	5.0	2.5	0K1	500
	RDE5C2A471J0K1H03B	C0G	100	470pF	±5%	4.0	3.5	6.0	5.0	2.5	0K1	500
	RDE5C2A561J0K1H03B	C0G	100	560pF	±5%	4.0	3.5	6.0	5.0	2.5	0K1	500
	RDE5C2A681J0K1H03B	C0G	100	680pF	±5%	4.0	3.5	6.0	5.0	2.5	0K1	500
	RDE5C2A821J0K1H03B	C0G	100	820pF	±5%	4.0	3.5	6.0	5.0	2.5	0K1	500
	RDE5C2A102J0K1H03B	C0G	100	1000pF	±5%	4.0	3.5	6.0	5.0	2.5	0K1	500

- Inside Crimp
(Lead Style : K*)

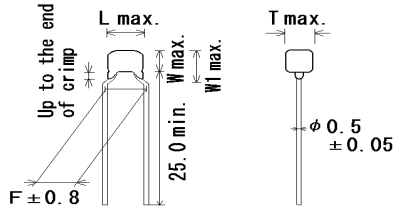

Unit : mm

Customer Part Number	Murata Part Number	T.C.	DC Rated Volt. (V)	Cap.	Cap. Tol.	Dimension (mm)					Dimension (LxW) Lead Style	Pack qty. (pcs)
						L	W	W1	F	T		
	RDE5C2A122J0K1H03B	C0G	100	1200pF	±5%	4.0	3.5	6.0	5.0	2.5	0K1	500
	RDE5C2A152J0K1H03B	C0G	100	1500pF	±5%	4.0	3.5	6.0	5.0	2.5	0K1	500
	RDE5C2A182J1K1H03B	C0G	100	1800pF	±5%	4.5	3.5	5.0	5.0	3.15	1K1	500
	RDE5C2A222J1K1H03B	C0G	100	2200pF	±5%	4.5	3.5	5.0	5.0	3.15	1K1	500
	RDE5C2A272J1K1H03B	C0G	100	2700pF	±5%	4.5	3.5	5.0	5.0	3.15	1K1	500
	RDE5C2A332J1K1H03B	C0G	100	3300pF	±5%	4.5	3.5	5.0	5.0	3.15	1K1	500
	RDE5C2A392J2K1H03B	C0G	100	3900pF	±5%	5.5	4.0	6.0	5.0	3.15	2K1	500
	RDE5C2A472J2K1H03B	C0G	100	4700pF	±5%	5.5	4.0	6.0	5.0	3.15	2K1	500
	RDE5C2A562J2K1H03B	C0G	100	5600pF	±5%	5.5	4.0	6.0	5.0	3.15	2K1	500
	RDE5C2A682J2K1H03B	C0G	100	6800pF	±5%	5.5	4.0	6.0	5.0	3.15	2K1	500
	RDE5C2A822J2K1H03B	C0G	100	8200pF	±5%	5.5	4.0	6.0	5.0	3.15	2K1	500
	RDE5C2A103J2K1H03B	C0G	100	10000pF	±5%	5.5	4.0	6.0	5.0	3.15	2K1	500
	RDE5C2A123J2K1H03B	C0G	100	12000pF	±5%	5.5	4.0	6.0	5.0	3.15	2K1	500
	RDE5C2A153J2K1H03B	C0G	100	15000pF	±5%	5.5	4.0	6.0	5.0	3.15	2K1	500
	RDE5C2A183J2K1H03B	C0G	100	18000pF	±5%	5.5	4.0	6.0	5.0	3.15	2K1	500
	RDE5C2A223J2K1H03B	C0G	100	22000pF	±5%	5.5	4.0	6.0	5.0	3.15	2K1	500

- Outside Crimp Taping
(Lead Style:S*)

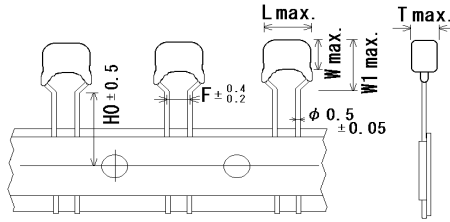

Unit : mm

Customer Part Number	Murata Part Number	T.C.	DC Rated Volt. (V)	Cap.	Cap. Tol.	Dimension (mm)						Dimension (LxW) Lead Style	Pack qty. (pcs)
						L	W	W1	F	T	H/H0		
	RDE5C1H1R0C0S1H03A	COG	50	1pF	±0.25pF	5.0	3.5	6.0	2.5	2.5	16.0	0S1	2000
	RDE5C1H2R0C0S1H03A	COG	50	2pF	±0.25pF	5.0	3.5	6.0	2.5	2.5	16.0	0S1	2000
	RDE5C1H3R0C0S1H03A	COG	50	3pF	±0.25pF	5.0	3.5	6.0	2.5	2.5	16.0	0S1	2000
	RDE5C1H4R0C0S1H03A	COG	50	4pF	±0.25pF	5.0	3.5	6.0	2.5	2.5	16.0	0S1	2000
	RDE5C1H5R0C0S1H03A	COG	50	5pF	±0.25pF	5.0	3.5	6.0	2.5	2.5	16.0	0S1	2000
	RDE5C1H6R0D0S1H03A	COG	50	6pF	±0.5pF	5.0	3.5	6.0	2.5	2.5	16.0	0S1	2000
	RDE5C1H7R0D0S1H03A	COG	50	7pF	±0.5pF	5.0	3.5	6.0	2.5	2.5	16.0	0S1	2000
	RDE5C1H8R0D0S1H03A	COG	50	8pF	±0.5pF	5.0	3.5	6.0	2.5	2.5	16.0	0S1	2000
	RDE5C1H9R0D0S1H03A	COG	50	9pF	±0.5pF	5.0	3.5	6.0	2.5	2.5	16.0	0S1	2000
	RDE5C1H100J0S1H03A	COG	50	10pF	±5%	5.0	3.5	6.0	2.5	2.5	16.0	0S1	2000
	RDE5C1H120J0S1H03A	COG	50	12pF	±5%	5.0	3.5	6.0	2.5	2.5	16.0	0S1	2000
	RDE5C1H150J0S1H03A	COG	50	15pF	±5%	5.0	3.5	6.0	2.5	2.5	16.0	0S1	2000
	RDE5C1H180J0S1H03A	COG	50	18pF	±5%	5.0	3.5	6.0	2.5	2.5	16.0	0S1	2000
	RDE5C1H220J0S1H03A	COG	50	22pF	±5%	5.0	3.5	6.0	2.5	2.5	16.0	0S1	2000
	RDE5C1H270J0S1H03A	COG	50	27pF	±5%	5.0	3.5	6.0	2.5	2.5	16.0	0S1	2000
	RDE5C1H330J0S1H03A	COG	50	33pF	±5%	5.0	3.5	6.0	2.5	2.5	16.0	0S1	2000
	RDE5C1H390J0S1H03A	COG	50	39pF	±5%	5.0	3.5	6.0	2.5	2.5	16.0	0S1	2000
	RDE5C1H470J0S1H03A	COG	50	47pF	±5%	5.0	3.5	6.0	2.5	2.5	16.0	0S1	2000
	RDE5C1H560J0S1H03A	COG	50	56pF	±5%	5.0	3.5	6.0	2.5	2.5	16.0	0S1	2000
	RDE5C1H680J0S1H03A	COG	50	68pF	±5%	5.0	3.5	6.0	2.5	2.5	16.0	0S1	2000
	RDE5C1H820J0S1H03A	COG	50	82pF	±5%	5.0	3.5	6.0	2.5	2.5	16.0	0S1	2000
	RDE5C1H101J0S1H03A	COG	50	100pF	±5%	5.0	3.5	6.0	2.5	2.5	16.0	0S1	2000
	RDE5C1H121J0S1H03A	COG	50	120pF	±5%	5.0	3.5	6.0	2.5	2.5	16.0	0S1	2000
	RDE5C1H151J0S1H03A	COG	50	150pF	±5%	5.0	3.5	6.0	2.5	2.5	16.0	0S1	2000
	RDE5C1H181J0S1H03A	COG	50	180pF	±5%	5.0	3.5	6.0	2.5	2.5	16.0	0S1	2000
	RDE5C1H221J0S1H03A	COG	50	220pF	±5%	5.0	3.5	6.0	2.5	2.5	16.0	0S1	2000
	RDE5C1H271J0S1H03A	COG	50	270pF	±5%	5.0	3.5	6.0	2.5	2.5	16.0	0S1	2000
	RDE5C1H331J0S1H03A	COG	50	330pF	±5%	5.0	3.5	6.0	2.5	2.5	16.0	0S1	2000
	RDE5C1H391J0S1H03A	COG	50	390pF	±5%	5.0	3.5	6.0	2.5	2.5	16.0	0S1	2000
	RDE5C1H471J0S1H03A	COG	50	470pF	±5%	5.0	3.5	6.0	2.5	2.5	16.0	0S1	2000
	RDE5C1H561J0S1H03A	COG	50	560pF	±5%	5.0	3.5	6.0	2.5	2.5	16.0	0S1	2000
	RDE5C1H681J0S1H03A	COG	50	680pF	±5%	5.0	3.5	6.0	2.5	2.5	16.0	0S1	2000
	RDE5C1H821J0S1H03A	COG	50	820pF	±5%	5.0	3.5	6.0	2.5	2.5	16.0	0S1	2000
	RDE5C1H102J0S1H03A	COG	50	1000pF	±5%	5.0	3.5	6.0	2.5	2.5	16.0	0S1	2000
	RDE5C1H122J0S1H03A	COG	50	1200pF	±5%	5.0	3.5	6.0	2.5	2.5	16.0	0S1	2000
	RDE5C1H152J0S1H03A	COG	50	1500pF	±5%	5.0	3.5	6.0	2.5	2.5	16.0	0S1	2000
	RDE5C1H182J0S1H03A	COG	50	1800pF	±5%	5.0	3.5	6.0	2.5	2.5	16.0	0S1	2000
	RDE5C1H222J0S1H03A	COG	50	2200pF	±5%	5.0	3.5	6.0	2.5	2.5	16.0	0S1	2000
	RDE5C1H272J0S1H03A	COG	50	2700pF	±5%	5.0	3.5	6.0	2.5	2.5	16.0	0S1	2000
	RDE5C1H332J0S1H03A	COG	50	3300pF	±5%	5.0	3.5	6.0	2.5	2.5	16.0	0S1	2000

- Outside Crimp Taping
(Lead Style:S*)

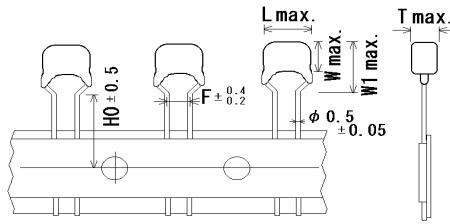

Unit : mm

Customer Part Number	Murata Part Number	T.C.	DC Rated Volt. (V)	Cap.	Cap. Tol.	Dimension (mm)						Dimension (LxW) Lead Style	Pack qty. (pcs)
						L	W	W1	F	T	H/H0		
	RDE5C1H392J0S1H03A	COG	50	3900pF	±5%	5.0	3.5	6.0	2.5	2.5	16.0	0S1	2000
	RDE5C1H472J1S1H03A	COG	50	4700pF	±5%	5.0	3.5	5.0	2.5	3.15	16.0	1S1	2000
	RDE5C1H562J1S1H03A	COG	50	5600pF	±5%	5.0	3.5	5.0	2.5	3.15	16.0	1S1	2000
	RDE5C1H682J1S1H03A	COG	50	6800pF	±5%	5.0	3.5	5.0	2.5	3.15	16.0	1S1	2000
	RDE5C1H822J1S1H03A	COG	50	8200pF	±5%	5.0	3.5	5.0	2.5	3.15	16.0	1S1	2000
	RDE5C1H103J1S1H03A	COG	50	10000pF	±5%	5.0	3.5	5.0	2.5	3.15	16.0	1S1	2000
	RDE5C1H123J1S1H03A	COG	50	12000pF	±5%	5.0	3.5	5.0	2.5	3.15	16.0	1S1	2000
	RDE5C1H153J1S1H03A	COG	50	15000pF	±5%	5.0	3.5	5.0	2.5	3.15	16.0	1S1	2000
	RDE5C1H183J1S1H03A	COG	50	18000pF	±5%	5.0	3.5	5.0	2.5	3.15	16.0	1S1	2000
	RDE5C1H223J1S1H03A	COG	50	22000pF	±5%	5.0	3.5	5.0	2.5	3.15	16.0	1S1	2000
	RDE5C1H273J2S1H03A	COG	50	27000pF	±5%	5.5	4.0	6.0	2.5	3.15	16.0	2S1	2000
	RDE5C1H333J2S1H03A	COG	50	33000pF	±5%	5.5	4.0	6.0	2.5	3.15	16.0	2S1	2000
	RDE5C1H393J2S1H03A	COG	50	39000pF	±5%	5.5	4.0	6.0	2.5	3.15	16.0	2S1	2000
	RDE5C1H473J2S1H03A	COG	50	47000pF	±5%	5.5	4.0	6.0	2.5	3.15	16.0	2S1	2000
	RDE5C1H563J2S1H03A	COG	50	56000pF	±5%	5.5	4.0	6.0	2.5	3.15	16.0	2S1	2000
	RDE5C1H683J2S1H03A	COG	50	68000pF	±5%	5.5	4.0	6.0	2.5	3.15	16.0	2S1	2000
	RDE5C1H823J2S1H03A	COG	50	82000pF	±5%	5.5	4.0	6.0	2.5	3.15	16.0	2S1	2000
	RDE5C1H104J2S1H03A	COG	50	0.1μF	±5%	5.5	4.0	6.0	2.5	3.15	16.0	2S1	2000
	RDE5C2A1R0C0S1H03A	COG	100	1pF	±0.25pF	5.0	3.5	6.0	2.5	2.5	16.0	0S1	2000
	RDE5C2A2R0C0S1H03A	COG	100	2pF	±0.25pF	5.0	3.5	6.0	2.5	2.5	16.0	0S1	2000
	RDE5C2A3R0C0S1H03A	COG	100	3pF	±0.25pF	5.0	3.5	6.0	2.5	2.5	16.0	0S1	2000
	RDE5C2A4R0C0S1H03A	COG	100	4pF	±0.25pF	5.0	3.5	6.0	2.5	2.5	16.0	0S1	2000
	RDE5C2A5R0C0S1H03A	COG	100	5pF	±0.25pF	5.0	3.5	6.0	2.5	2.5	16.0	0S1	2000
	RDE5C2A6R0D0S1H03A	COG	100	6pF	±0.5pF	5.0	3.5	6.0	2.5	2.5	16.0	0S1	2000
	RDE5C2A7R0D0S1H03A	COG	100	7pF	±0.5pF	5.0	3.5	6.0	2.5	2.5	16.0	0S1	2000
	RDE5C2A8R0D0S1H03A	COG	100	8pF	±0.5pF	5.0	3.5	6.0	2.5	2.5	16.0	0S1	2000
	RDE5C2A9R0D0S1H03A	COG	100	9pF	±0.5pF	5.0	3.5	6.0	2.5	2.5	16.0	0S1	2000
	RDE5C2A100J0S1H03A	COG	100	10pF	±5%	5.0	3.5	6.0	2.5	2.5	16.0	0S1	2000
	RDE5C2A120J0S1H03A	COG	100	12pF	±5%	5.0	3.5	6.0	2.5	2.5	16.0	0S1	2000
	RDE5C2A150J0S1H03A	COG	100	15pF	±5%	5.0	3.5	6.0	2.5	2.5	16.0	0S1	2000
	RDE5C2A180J0S1H03A	COG	100	18pF	±5%	5.0	3.5	6.0	2.5	2.5	16.0	0S1	2000
	RDE5C2A220J0S1H03A	COG	100	22pF	±5%	5.0	3.5	6.0	2.5	2.5	16.0	0S1	2000
	RDE5C2A270J0S1H03A	COG	100	27pF	±5%	5.0	3.5	6.0	2.5	2.5	16.0	0S1	2000
	RDE5C2A330J0S1H03A	COG	100	33pF	±5%	5.0	3.5	6.0	2.5	2.5	16.0	0S1	2000
	RDE5C2A390J0S1H03A	COG	100	39pF	±5%	5.0	3.5	6.0	2.5	2.5	16.0	0S1	2000
	RDE5C2A470J0S1H03A	COG	100	47pF	±5%	5.0	3.5	6.0	2.5	2.5	16.0	0S1	2000
	RDE5C2A560J0S1H03A	COG	100	56pF	±5%	5.0	3.5	6.0	2.5	2.5	16.0	0S1	2000
	RDE5C2A680J0S1H03A	COG	100	68pF	±5%	5.0	3.5	6.0	2.5	2.5	16.0	0S1	2000
	RDE5C2A820J0S1H03A	COG	100	82pF	±5%	5.0	3.5	6.0	2.5	2.5	16.0	0S1	2000
	RDE5C2A101J0S1H03A	COG	100	100pF	±5%	5.0	3.5	6.0	2.5	2.5	16.0	0S1	2000

Reference only

• Outside Crimp Taping
(Lead Style: S*)

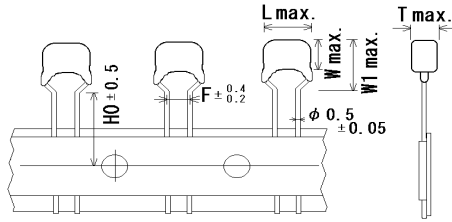

• Inside Crimp Taping
(Lead Style: M*)

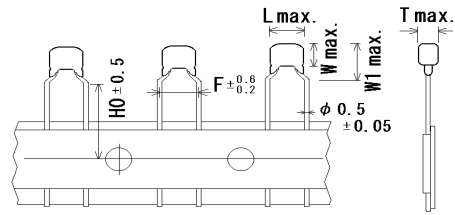

Unit : mm

Customer Part Number	Murata Part Number	T.C.	DC Rated Volt. (V)	Cap.	Cap. Tol.	Dimension (mm)						Dimension (LxW) Lead Style	Pack qty. (pcs)
						L	W	W1	F	T	H/H0		
	RDE5C2A121J0S1H03A	COG	100	120pF	±5%	5.0	3.5	6.0	2.5	2.5	16.0	0S1	2000
	RDE5C2A151J0S1H03A	COG	100	150pF	±5%	5.0	3.5	6.0	2.5	2.5	16.0	0S1	2000
	RDE5C2A181J0S1H03A	COG	100	180pF	±5%	5.0	3.5	6.0	2.5	2.5	16.0	0S1	2000
	RDE5C2A221J0S1H03A	COG	100	220pF	±5%	5.0	3.5	6.0	2.5	2.5	16.0	0S1	2000
	RDE5C2A271J0S1H03A	COG	100	270pF	±5%	5.0	3.5	6.0	2.5	2.5	16.0	0S1	2000
	RDE5C2A331J0S1H03A	COG	100	330pF	±5%	5.0	3.5	6.0	2.5	2.5	16.0	0S1	2000
	RDE5C2A391J0S1H03A	COG	100	390pF	±5%	5.0	3.5	6.0	2.5	2.5	16.0	0S1	2000
	RDE5C2A471J0S1H03A	COG	100	470pF	±5%	5.0	3.5	6.0	2.5	2.5	16.0	0S1	2000
	RDE5C2A561J0S1H03A	COG	100	560pF	±5%	5.0	3.5	6.0	2.5	2.5	16.0	0S1	2000
	RDE5C2A681J0S1H03A	COG	100	680pF	±5%	5.0	3.5	6.0	2.5	2.5	16.0	0S1	2000
	RDE5C2A821J0S1H03A	COG	100	820pF	±5%	5.0	3.5	6.0	2.5	2.5	16.0	0S1	2000
	RDE5C2A102J0S1H03A	COG	100	1000pF	±5%	5.0	3.5	6.0	2.5	2.5	16.0	0S1	2000
	RDE5C2A122J0S1H03A	COG	100	1200pF	±5%	5.0	3.5	6.0	2.5	2.5	16.0	0S1	2000
	RDE5C2A152J0S1H03A	COG	100	1500pF	±5%	5.0	3.5	6.0	2.5	2.5	16.0	0S1	2000
	RDE5C2A182J1S1H03A	COG	100	1800pF	±5%	5.0	3.5	5.0	2.5	3.15	16.0	1S1	2000
	RDE5C2A222J1S1H03A	COG	100	2200pF	±5%	5.0	3.5	5.0	2.5	3.15	16.0	1S1	2000
	RDE5C2A272J1S1H03A	COG	100	2700pF	±5%	5.0	3.5	5.0	2.5	3.15	16.0	1S1	2000
	RDE5C2A332J1S1H03A	COG	100	3300pF	±5%	5.0	3.5	5.0	2.5	3.15	16.0	1S1	2000
	RDE5C2A392J2S1H03A	COG	100	3900pF	±5%	5.5	4.0	6.0	2.5	3.15	16.0	2S1	2000
	RDE5C2A472J2S1H03A	COG	100	4700pF	±5%	5.5	4.0	6.0	2.5	3.15	16.0	2S1	2000
	RDE5C2A562J2S1H03A	COG	100	5600pF	±5%	5.5	4.0	6.0	2.5	3.15	16.0	2S1	2000
	RDE5C2A682J2S1H03A	COG	100	6800pF	±5%	5.5	4.0	6.0	2.5	3.15	16.0	2S1	2000
	RDE5C2A822J2S1H03A	COG	100	8200pF	±5%	5.5	4.0	6.0	2.5	3.15	16.0	2S1	2000
	RDE5C2A103J2S1H03A	COG	100	10000pF	±5%	5.5	4.0	6.0	2.5	3.15	16.0	2S1	2000
	RDE5C2A123J2S1H03A	COG	100	12000pF	±5%	5.5	4.0	6.0	2.5	3.15	16.0	2S1	2000
	RDE5C2A153J2S1H03A	COG	100	15000pF	±5%	5.5	4.0	6.0	2.5	3.15	16.0	2S1	2000
	RDE5C2A183J2S1H03A	COG	100	18000pF	±5%	5.5	4.0	6.0	2.5	3.15	16.0	2S1	2000
	RDE5C2A223J2S1H03A	COG	100	22000pF	±5%	5.5	4.0	6.0	2.5	3.15	16.0	2S1	2000
	RDE5C1H1R0C0M1H03A	COG	50	1pF	±0.25pF	4.0	3.5	6.0	5.0	2.5	16.0	0M1	2000
	RDE5C1H2R0C0M1H03A	COG	50	2pF	±0.25pF	4.0	3.5	6.0	5.0	2.5	16.0	0M1	2000
	RDE5C1H3R0C0M1H03A	COG	50	3pF	±0.25pF	4.0	3.5	6.0	5.0	2.5	16.0	0M1	2000
	RDE5C1H4R0C0M1H03A	COG	50	4pF	±0.25pF	4.0	3.5	6.0	5.0	2.5	16.0	0M1	2000
	RDE5C1H5R0C0M1H03A	COG	50	5pF	±0.25pF	4.0	3.5	6.0	5.0	2.5	16.0	0M1	2000
	RDE5C1H6R0D0M1H03A	COG	50	6pF	±0.5pF	4.0	3.5	6.0	5.0	2.5	16.0	0M1	2000
	RDE5C1H7R0D0M1H03A	COG	50	7pF	±0.5pF	4.0	3.5	6.0	5.0	2.5	16.0	0M1	2000
	RDE5C1H8R0D0M1H03A	COG	50	8pF	±0.5pF	4.0	3.5	6.0	5.0	2.5	16.0	0M1	2000
	RDE5C1H9R0D0M1H03A	COG	50	9pF	±0.5pF	4.0	3.5	6.0	5.0	2.5	16.0	0M1	2000
	RDE5C1H100J0M1H03A	COG	50	10pF	±5%	4.0	3.5	6.0	5.0	2.5	16.0	0M1	2000
	RDE5C1H120J0M1H03A	COG	50	12pF	±5%	4.0	3.5	6.0	5.0	2.5	16.0	0M1	2000
	RDE5C1H150J0M1H03A	COG	50	15pF	±5%	4.0	3.5	6.0	5.0	2.5	16.0	0M1	2000

• Inside Crimp Taping
(Lead Style: M*)

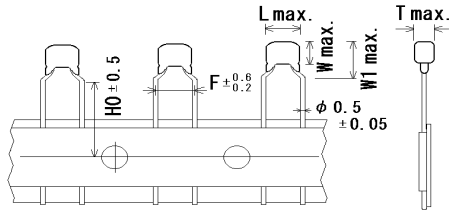

Unit : mm

Customer Part Number	Murata Part Number	T.C.	DC Rated Volt. (V)	Cap.	Cap. Tol.	Dimension (mm)						Dimension (LxW) Lead Style	Pack qty. (pcs)
						L	W	W1	F	T	H/H0		
	RDE5C1H180J0M1H03A	COG	50	18pF	±5%	4.0	3.5	6.0	5.0	2.5	16.0	0M1	2000
	RDE5C1H220J0M1H03A	COG	50	22pF	±5%	4.0	3.5	6.0	5.0	2.5	16.0	0M1	2000
	RDE5C1H270J0M1H03A	COG	50	27pF	±5%	4.0	3.5	6.0	5.0	2.5	16.0	0M1	2000
	RDE5C1H330J0M1H03A	COG	50	33pF	±5%	4.0	3.5	6.0	5.0	2.5	16.0	0M1	2000
	RDE5C1H390J0M1H03A	COG	50	39pF	±5%	4.0	3.5	6.0	5.0	2.5	16.0	0M1	2000
	RDE5C1H470J0M1H03A	COG	50	47pF	±5%	4.0	3.5	6.0	5.0	2.5	16.0	0M1	2000
	RDE5C1H560J0M1H03A	COG	50	56pF	±5%	4.0	3.5	6.0	5.0	2.5	16.0	0M1	2000
	RDE5C1H680J0M1H03A	COG	50	68pF	±5%	4.0	3.5	6.0	5.0	2.5	16.0	0M1	2000
	RDE5C1H820J0M1H03A	COG	50	82pF	±5%	4.0	3.5	6.0	5.0	2.5	16.0	0M1	2000
	RDE5C1H101J0M1H03A	COG	50	100pF	±5%	4.0	3.5	6.0	5.0	2.5	16.0	0M1	2000
	RDE5C1H121J0M1H03A	COG	50	120pF	±5%	4.0	3.5	6.0	5.0	2.5	16.0	0M1	2000
	RDE5C1H151J0M1H03A	COG	50	150pF	±5%	4.0	3.5	6.0	5.0	2.5	16.0	0M1	2000
	RDE5C1H181J0M1H03A	COG	50	180pF	±5%	4.0	3.5	6.0	5.0	2.5	16.0	0M1	2000
	RDE5C1H221J0M1H03A	COG	50	220pF	±5%	4.0	3.5	6.0	5.0	2.5	16.0	0M1	2000
	RDE5C1H271J0M1H03A	COG	50	270pF	±5%	4.0	3.5	6.0	5.0	2.5	16.0	0M1	2000
	RDE5C1H331J0M1H03A	COG	50	330pF	±5%	4.0	3.5	6.0	5.0	2.5	16.0	0M1	2000
	RDE5C1H391J0M1H03A	COG	50	390pF	±5%	4.0	3.5	6.0	5.0	2.5	16.0	0M1	2000
	RDE5C1H471J0M1H03A	COG	50	470pF	±5%	4.0	3.5	6.0	5.0	2.5	16.0	0M1	2000
	RDE5C1H561J0M1H03A	COG	50	560pF	±5%	4.0	3.5	6.0	5.0	2.5	16.0	0M1	2000
	RDE5C1H681J0M1H03A	COG	50	680pF	±5%	4.0	3.5	6.0	5.0	2.5	16.0	0M1	2000
	RDE5C1H821J0M1H03A	COG	50	820pF	±5%	4.0	3.5	6.0	5.0	2.5	16.0	0M1	2000
	RDE5C1H102J0M1H03A	COG	50	1000pF	±5%	4.0	3.5	6.0	5.0	2.5	16.0	0M1	2000
	RDE5C1H122J0M1H03A	COG	50	1200pF	±5%	4.0	3.5	6.0	5.0	2.5	16.0	0M1	2000
	RDE5C1H152J0M1H03A	COG	50	1500pF	±5%	4.0	3.5	6.0	5.0	2.5	16.0	0M1	2000
	RDE5C1H182J0M1H03A	COG	50	1800pF	±5%	4.0	3.5	6.0	5.0	2.5	16.0	0M1	2000
	RDE5C1H222J0M1H03A	COG	50	2200pF	±5%	4.0	3.5	6.0	5.0	2.5	16.0	0M1	2000
	RDE5C1H272J0M1H03A	COG	50	2700pF	±5%	4.0	3.5	6.0	5.0	2.5	16.0	0M1	2000
	RDE5C1H332J0M1H03A	COG	50	3300pF	±5%	4.0	3.5	6.0	5.0	2.5	16.0	0M1	2000
	RDE5C1H392J0M1H03A	COG	50	3900pF	±5%	4.0	3.5	6.0	5.0	2.5	16.0	0M1	2000
	RDE5C1H472J1M1H03A	COG	50	4700pF	±5%	4.5	3.5	5.0	5.0	3.15	16.0	1M1	2000
	RDE5C1H562J1M1H03A	COG	50	5600pF	±5%	4.5	3.5	5.0	5.0	3.15	16.0	1M1	2000
	RDE5C1H682J1M1H03A	COG	50	6800pF	±5%	4.5	3.5	5.0	5.0	3.15	16.0	1M1	2000
	RDE5C1H822J1M1H03A	COG	50	8200pF	±5%	4.5	3.5	5.0	5.0	3.15	16.0	1M1	2000
	RDE5C1H103J1M1H03A	COG	50	10000pF	±5%	4.5	3.5	5.0	5.0	3.15	16.0	1M1	2000
	RDE5C1H123J1M1H03A	COG	50	12000pF	±5%	4.5	3.5	5.0	5.0	3.15	16.0	1M1	2000
	RDE5C1H153J1M1H03A	COG	50	15000pF	±5%	4.5	3.5	5.0	5.0	3.15	16.0	1M1	2000
	RDE5C1H183J1M1H03A	COG	50	18000pF	±5%	4.5	3.5	5.0	5.0	3.15	16.0	1M1	2000
	RDE5C1H223J1M1H03A	COG	50	22000pF	±5%	4.5	3.5	5.0	5.0	3.15	16.0	1M1	2000
	RDE5C1H273J2M1H03A	COG	50	27000pF	±5%	5.5	4.0	6.0	5.0	3.15	16.0	2M1	2000
	RDE5C1H333J2M1H03A	COG	50	33000pF	±5%	5.5	4.0	6.0	5.0	3.15	16.0	2M1	2000

• Inside Crimp Taping
(Lead Style: M*)

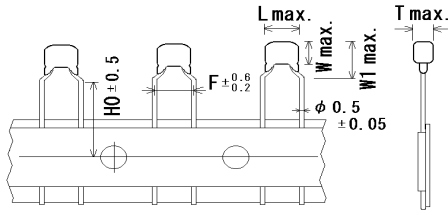

Unit : mm

Customer Part Number	Murata Part Number	T.C.	DC Rated Volt. (V)	Cap.	Cap. Tol.	Dimension (mm)						Dimension (LxW) Lead Style	Pack qty. (pcs)
						L	W	W1	F	T	H/H0		
	RDE5C1H393J2M1H03A	COG	50	39000pF	±5%	5.5	4.0	6.0	5.0	3.15	16.0	2M1	2000
	RDE5C1H473J2M1H03A	COG	50	47000pF	±5%	5.5	4.0	6.0	5.0	3.15	16.0	2M1	2000
	RDE5C1H563J2M1H03A	COG	50	56000pF	±5%	5.5	4.0	6.0	5.0	3.15	16.0	2M1	2000
	RDE5C1H683J2M1H03A	COG	50	68000pF	±5%	5.5	4.0	6.0	5.0	3.15	16.0	2M1	2000
	RDE5C1H823J2M1H03A	COG	50	82000pF	±5%	5.5	4.0	6.0	5.0	3.15	16.0	2M1	2000
	RDE5C1H104J2M1H03A	COG	50	0.1μF	±5%	5.5	4.0	6.0	5.0	3.15	16.0	2M1	2000
	RDE5C2A1R0C0M1H03A	COG	100	1pF	±0.25pF	4.0	3.5	6.0	5.0	2.5	16.0	0M1	2000
	RDE5C2A2R0C0M1H03A	COG	100	2pF	±0.25pF	4.0	3.5	6.0	5.0	2.5	16.0	0M1	2000
	RDE5C2A3R0C0M1H03A	COG	100	3pF	±0.25pF	4.0	3.5	6.0	5.0	2.5	16.0	0M1	2000
	RDE5C2A4R0C0M1H03A	COG	100	4pF	±0.25pF	4.0	3.5	6.0	5.0	2.5	16.0	0M1	2000
	RDE5C2A5R0C0M1H03A	COG	100	5pF	±0.25pF	4.0	3.5	6.0	5.0	2.5	16.0	0M1	2000
	RDE5C2A6R0D0M1H03A	COG	100	6pF	±0.5pF	4.0	3.5	6.0	5.0	2.5	16.0	0M1	2000
	RDE5C2A7R0D0M1H03A	COG	100	7pF	±0.5pF	4.0	3.5	6.0	5.0	2.5	16.0	0M1	2000
	RDE5C2A8R0D0M1H03A	COG	100	8pF	±0.5pF	4.0	3.5	6.0	5.0	2.5	16.0	0M1	2000
	RDE5C2A9R0D0M1H03A	COG	100	9pF	±0.5pF	4.0	3.5	6.0	5.0	2.5	16.0	0M1	2000
	RDE5C2A100J0M1H03A	COG	100	10pF	±5%	4.0	3.5	6.0	5.0	2.5	16.0	0M1	2000
	RDE5C2A120J0M1H03A	COG	100	12pF	±5%	4.0	3.5	6.0	5.0	2.5	16.0	0M1	2000
	RDE5C2A150J0M1H03A	COG	100	15pF	±5%	4.0	3.5	6.0	5.0	2.5	16.0	0M1	2000
	RDE5C2A180J0M1H03A	COG	100	18pF	±5%	4.0	3.5	6.0	5.0	2.5	16.0	0M1	2000
	RDE5C2A220J0M1H03A	COG	100	22pF	±5%	4.0	3.5	6.0	5.0	2.5	16.0	0M1	2000
	RDE5C2A270J0M1H03A	COG	100	27pF	±5%	4.0	3.5	6.0	5.0	2.5	16.0	0M1	2000
	RDE5C2A330J0M1H03A	COG	100	33pF	±5%	4.0	3.5	6.0	5.0	2.5	16.0	0M1	2000
	RDE5C2A390J0M1H03A	COG	100	39pF	±5%	4.0	3.5	6.0	5.0	2.5	16.0	0M1	2000
	RDE5C2A470J0M1H03A	COG	100	47pF	±5%	4.0	3.5	6.0	5.0	2.5	16.0	0M1	2000
	RDE5C2A560J0M1H03A	COG	100	56pF	±5%	4.0	3.5	6.0	5.0	2.5	16.0	0M1	2000
	RDE5C2A680J0M1H03A	COG	100	68pF	±5%	4.0	3.5	6.0	5.0	2.5	16.0	0M1	2000
	RDE5C2A820J0M1H03A	COG	100	82pF	±5%	4.0	3.5	6.0	5.0	2.5	16.0	0M1	2000
	RDE5C2A101J0M1H03A	COG	100	100pF	±5%	4.0	3.5	6.0	5.0	2.5	16.0	0M1	2000
	RDE5C2A121J0M1H03A	COG	100	120pF	±5%	4.0	3.5	6.0	5.0	2.5	16.0	0M1	2000
	RDE5C2A151J0M1H03A	COG	100	150pF	±5%	4.0	3.5	6.0	5.0	2.5	16.0	0M1	2000
	RDE5C2A181J0M1H03A	COG	100	180pF	±5%	4.0	3.5	6.0	5.0	2.5	16.0	0M1	2000
	RDE5C2A221J0M1H03A	COG	100	220pF	±5%	4.0	3.5	6.0	5.0	2.5	16.0	0M1	2000
	RDE5C2A271J0M1H03A	COG	100	270pF	±5%	4.0	3.5	6.0	5.0	2.5	16.0	0M1	2000
	RDE5C2A331J0M1H03A	COG	100	330pF	±5%	4.0	3.5	6.0	5.0	2.5	16.0	0M1	2000
	RDE5C2A391J0M1H03A	COG	100	390pF	±5%	4.0	3.5	6.0	5.0	2.5	16.0	0M1	2000
	RDE5C2A471J0M1H03A	COG	100	470pF	±5%	4.0	3.5	6.0	5.0	2.5	16.0	0M1	2000
	RDE5C2A561J0M1H03A	COG	100	560pF	±5%	4.0	3.5	6.0	5.0	2.5	16.0	0M1	2000
	RDE5C2A681J0M1H03A	COG	100	680pF	±5%	4.0	3.5	6.0	5.0	2.5	16.0	0M1	2000
	RDE5C2A821J0M1H03A	COG	100	820pF	±5%	4.0	3.5	6.0	5.0	2.5	16.0	0M1	2000
	RDE5C2A102J0M1H03A	COG	100	1000pF	±5%	4.0	3.5	6.0	5.0	2.5	16.0	0M1	2000

• Inside Crimp Taping
(Lead Style: M*)

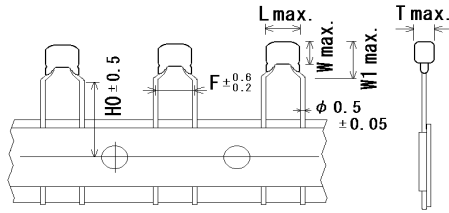

Unit : mm

Customer Part Number	Murata Part Number	T.C.	DC Rated Volt. (V)	Cap.	Cap. Tol.	Dimension (mm)						Dimension (LxW) Lead Style	Pack qty. (pcs)
						L	W	W1	F	T	H/H0		
	RDE5C2A122J0M1H03A	C0G	100	1200pF	±5%	4.0	3.5	6.0	5.0	2.5	16.0	0M1	2000
	RDE5C2A152J0M1H03A	C0G	100	1500pF	±5%	4.0	3.5	6.0	5.0	2.5	16.0	0M1	2000
	RDE5C2A182J1M1H03A	C0G	100	1800pF	±5%	4.5	3.5	5.0	5.0	3.15	16.0	1M1	2000
	RDE5C2A222J1M1H03A	C0G	100	2200pF	±5%	4.5	3.5	5.0	5.0	3.15	16.0	1M1	2000
	RDE5C2A272J1M1H03A	C0G	100	2700pF	±5%	4.5	3.5	5.0	5.0	3.15	16.0	1M1	2000
	RDE5C2A332J1M1H03A	C0G	100	3300pF	±5%	4.5	3.5	5.0	5.0	3.15	16.0	1M1	2000
	RDE5C2A392J2M1H03A	C0G	100	3900pF	±5%	5.5	4.0	6.0	5.0	3.15	16.0	2M1	2000
	RDE5C2A472J2M1H03A	C0G	100	4700pF	±5%	5.5	4.0	6.0	5.0	3.15	16.0	2M1	2000
	RDE5C2A562J2M1H03A	C0G	100	5600pF	±5%	5.5	4.0	6.0	5.0	3.15	16.0	2M1	2000
	RDE5C2A682J2M1H03A	C0G	100	6800pF	±5%	5.5	4.0	6.0	5.0	3.15	16.0	2M1	2000
	RDE5C2A822J2M1H03A	C0G	100	8200pF	±5%	5.5	4.0	6.0	5.0	3.15	16.0	2M1	2000
	RDE5C2A103J2M1H03A	C0G	100	10000pF	±5%	5.5	4.0	6.0	5.0	3.15	16.0	2M1	2000
	RDE5C2A123J2M1H03A	C0G	100	12000pF	±5%	5.5	4.0	6.0	5.0	3.15	16.0	2M1	2000
	RDE5C2A153J2M1H03A	C0G	100	15000pF	±5%	5.5	4.0	6.0	5.0	3.15	16.0	2M1	2000
	RDE5C2A183J2M1H03A	C0G	100	18000pF	±5%	5.5	4.0	6.0	5.0	3.15	16.0	2M1	2000
	RDE5C2A223J2M1H03A	C0G	100	22000pF	±5%	5.5	4.0	6.0	5.0	3.15	16.0	2M1	2000

Reference only

5. SPECIFICATIONS AND TEST METHODS																
No.	Item		Specification	Test Method												
1	Appearance		No defects or abnormalities.	Visual inspection.												
2	Dimension and Marking		Within the specified dimensions and Marking	Visual inspection, Using Caliper.												
3	Dielectric Strength	Between Terminals	No defects or abnormalities.	The capacitor should not be damaged when DC voltage of 300% of the rated voltage is applied between the terminations for 1 to 5 seconds. (Charge/Discharge current \leq 50mA.) The capacitor is placed in a container with metal balls of 1mm diameter so that each terminal, short-circuit, is kept approximately 2mm from the balls, and 250% of the rated DC voltage is impressed for 1 to 5 seconds between capacitor terminals and metal balls. (Charge/Discharge current \leq 50mA.)												
		Body Insulation	No defects or abnormalities.													
4	Insulation Resistance (I.R.)	Between Terminals	10,000M Ω or 500M Ω · μ F min. (Whichever is smaller)	The insulation resistance should be measured with a DC voltage not exceeding the rated voltage at normal temperature and humidity and within 2 minutes of charging. (Charge/Discharge current \leq 50mA.)												
5	Capacitance		Within the specified tolerance.	The capacitance, Q should be measured at 25°C at the frequency and voltage shown in the table.												
6	Q		30pF \leq C : Q \geq 1,000 30pF > C : Q \geq 400+20C C : Nominal Capacitance (pF)													
				<table border="1"> <thead> <tr> <th>Nominal Cap.</th> <th>Frequency</th> <th>Voltage</th> </tr> </thead> <tbody> <tr> <td>C \leq 1000pF</td> <td>1\pm0.1MHz</td> <td>AC0.5 to 5V(r.m.s.)</td> </tr> <tr> <td>C > 1000pF</td> <td>1\pm0.1kHz</td> <td>AC1\pm0.2V(r.m.s.)</td> </tr> </tbody> </table>	Nominal Cap.	Frequency	Voltage	C \leq 1000pF	1 \pm 0.1MHz	AC0.5 to 5V(r.m.s.)	C > 1000pF	1 \pm 0.1kHz	AC1 \pm 0.2V(r.m.s.)			
Nominal Cap.	Frequency	Voltage														
C \leq 1000pF	1 \pm 0.1MHz	AC0.5 to 5V(r.m.s.)														
C > 1000pF	1 \pm 0.1kHz	AC1 \pm 0.2V(r.m.s.)														
7	Capacitance Temperature Characteristics		Within the specified Tolerance. 25°C to 125°C : 0 \pm 30 ppm/°C -55°C to 25°C : 0+30/-72 ppm/°C	<p>The capacitance change should be measured after 5 minutes at each specified temperature stage.</p> <p>The temperature coefficient is determined using the capacitance measured in step 3 as a reference.</p> <p>When cycling the temperature sequentially from step 1 through 5 (-55°C to 125°C) the capacitance should be within the specified tolerance for the temperature coefficient and capacitance change as Table A.</p> <p>The capacitance drift is calculated by dividing the differences between the maximum and minimum measured values in the step 1, 3 and 5 by the capacitance value in step 3.</p> <table border="1"> <thead> <tr> <th>Step</th> <th>Temperature(°C)</th> </tr> </thead> <tbody> <tr> <td>1</td> <td>25\pm2</td> </tr> <tr> <td>2</td> <td>-55\pm3</td> </tr> <tr> <td>3</td> <td>25\pm2</td> </tr> <tr> <td>4</td> <td>125\pm3</td> </tr> <tr> <td>5</td> <td>25\pm2</td> </tr> </tbody> </table>	Step	Temperature(°C)	1	25 \pm 2	2	-55 \pm 3	3	25 \pm 2	4	125 \pm 3	5	25 \pm 2
Step	Temperature(°C)															
1	25 \pm 2															
2	-55 \pm 3															
3	25 \pm 2															
4	125 \pm 3															
5	25 \pm 2															
8	Terminal Strength	Tensile Strength	Termination not to be broken or loosened	<p>As in the figure, fix the capacitor body, apply the force gradually to each lead in the radial direction of the capacitor until reaching 10N and then keep applied the force for 10\pm1 seconds.</p> 												
		Bending Strength	Termination not to be broken or loosened		<p>Each lead wire should be subjected to a force of 2.5N and then be bent 90° at the point of egress in one direction.</p> <p>Each wire is then returned to the original position and bent 90° in the opposite direction at the rate of one bend per 2 to 3 seconds.</p>											
9	Vibration Resistance	Appearance	No defects or abnormalities.	The capacitor should be subjected to a simple harmonic motion having a total amplitude of 1.5mm, the frequency being varied uniformly between the approximate limits of 10Hz and 55Hz. The frequency range, from 10Hz to 55Hz and return to 10Hz, shall be traversed in approximately 1 minute. This motion shall be applied for a period of 2 hours in each 3 mutually perpendicular directions (total of 6 hours).												
		Capacitance	Within the specified tolerance.													
		Q	30pF \leq C : Q \geq 1,000 30pF > C : Q \geq 400+20C C : Nominal Capacitance (pF)													
10	Solderability of Lead		Solder is deposited on unintermittingly immersed portion in axial direction covering 3/4 or more in circumferential direction of lead wires.	<p>The terminal of capacitor is dipped into a solution of ethanol (JIS K 8101) and rosin (JIS K 5902) (25% rosin in weight proportion). Immerse in solder solution for 2\pm0.5 seconds. In both cases the depth of dipping is up to about 1.5 to 2mm from the terminal body.</p> <p>Temp. of solder :</p> <p>245\pm5°C Lead Free Solder (Sn-3.0Ag-0.5Cu) 235\pm5°C H60A or H63A Eutectic Solder</p>												

Reference only

No.	Item	Specification	Test Method
11-1	Resistance to Soldering Heat (Non-Preheat)	Appearance	The lead wires should be immersed in the melted solder 1.5 to 2.0mm from the root of terminal at 260±5°C for 10±1 seconds. • Post-treatment Capacitor should be stored for 24±2 hours at *room condition.
		Capacitance Change	
		Dielectric Strength (Between terminals)	
11-2	Resistance to Soldering Heat (On-Preheat)	Appearance	First the capacitor should be stored at 120+0/-5°C for 60+0/-5 seconds. Then, the lead wires should be immersed in the melted solder 1.5 to 2.0mm from the root of terminal at 260±5°C for 7.5+0/-1 seconds. • Post-treatment Capacitor should be stored for 24±2 hours at *room condition.
		Capacitance Change	
		Dielectric Strength (Between terminals)	
11-3	Resistance to Soldering Heat (soldering iron method)	Appearance	Test condition Temperature of iron-tip : 350±10°C Soldering time : 3.5±0.5 seconds Soldering position Straight Lead : 1.5 to 2.0mm from the root of terminal. Crimp Lead : 1.5 to 2.0mm from the end of lead bend. • Post-treatment Capacitor should be stored for 24±2 hours at *room condition.
		Capacitance Change	
		Dielectric Strength (Between terminals)	
12	Temperature Cycle	Appearance	Repeat 5 cycles according to the 4 heat treatments listed in the following table. Set at *room condition for 24±2 hours, then measure.
		Capacitance Change	
		Q	
		I.R.	
		Dielectric Strength (Between Terminals)	
13	Humidity (Steady State)	Appearance	Set the capacitor at 40±2°C and relative humidity 90 to 95% for 500+24/-0 hours. Remove and set for 24±2 hours at *room condition, then measure.
		Capacitance Change	
		Q	
		I.R.	
		Dielectric Strength (Between Terminals)	
14	Humidity Load	Appearance	Apply the rated voltage at 40±2°C and relative humidity of 90 to 95% for 500+24/-0 hours. Remove and set for 24±2 hours at *room condition, then measure. (Charge/Discharge current ≤ 50mA)
		Capacitance Change	
		Q	
		I.R.	

Step	1	2	3	4
Temp. (°C)	Min. Operating Temp. ±3	Room Temp.	Max. Operating Temp. ±3	Room Temp.
Time (min.)	30±3	3 max.	30±3	3 max.

* "room condition" Temperature : 15 to 35°C, Relative humidity : 45 to 75%, Atmosphere pressure : 86 to 106kPa

Reference only

No.	Item	Specification	Test Method
15	High Temperature Load	Appearance	Apply 150% of the rated voltage at the maximum operating temperature $\pm 3^{\circ}\text{C}$ for 1000+48/-0 hours. Remove and set for 24 \pm 2 hours at *room condition, then measure. (Charge/Discharge current $\leq 50\text{mA}$)
		Capacitance	
		Change	
		Q	
		I.R.	
	Marking	Legible	
16	Solvent Resistance	Appearance	The capacitor should be fully immersed, unagitated, in reagent at 20 to 25 $^{\circ}\text{C}$ for 30 \pm 5 seconds and then remove gently. Marking on the surface of the capacitor shall immediately be visually examined. Regent : Isopropyl alcohol
		Marking	

* "room condition" Temperature : 15 to 35 $^{\circ}\text{C}$, Relative humidity : 45 to 75%, Atmosphere pressure : 86 to 106kPa

6. Packing specification

- Bulk type (Packing style code : B)

The size of packing case and packing way

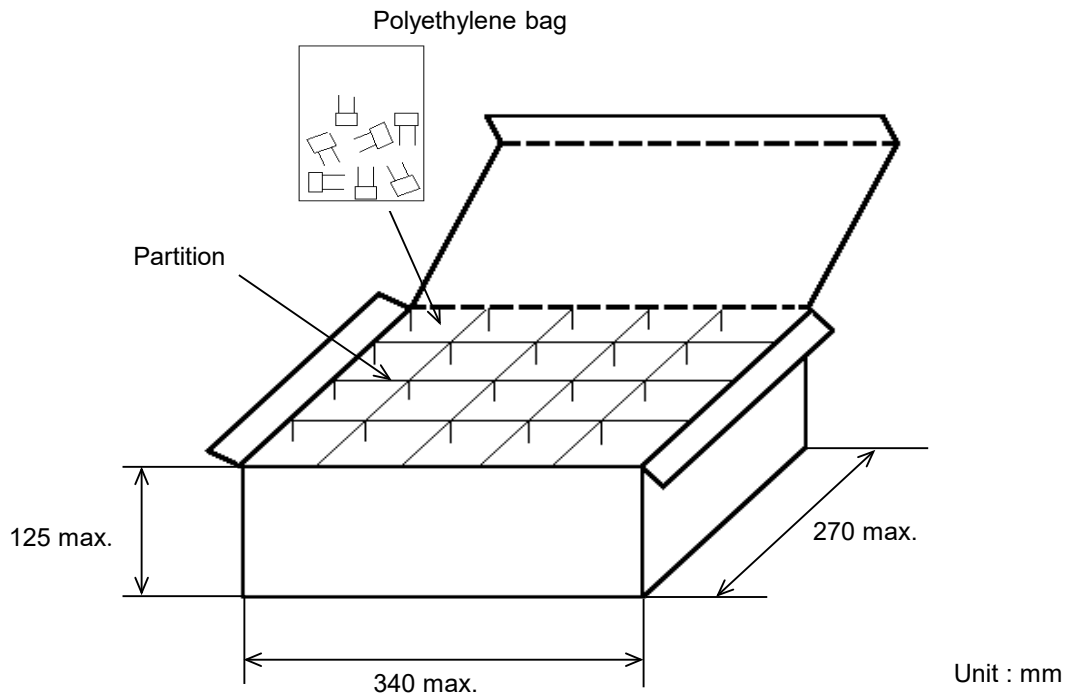

The number of packing = ^{*1} Packing quantity × ^{*2} n

*1 : Please refer to [Part number list].

*2 : Standard n = 20 (bag)

Note)

The outer package and the number of outer packing be changed by the order getting amount.

• Ammo pack taping type (Packing style code : A)

A crease is made every 25 pitches, and the tape with capacitors is packed zigzag into a case. When body of the capacitor is piled on other body under it.

The size of packing case and packing way

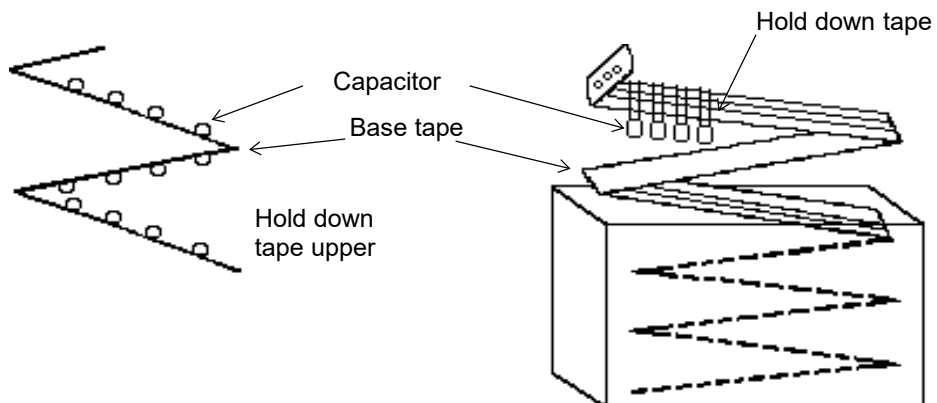
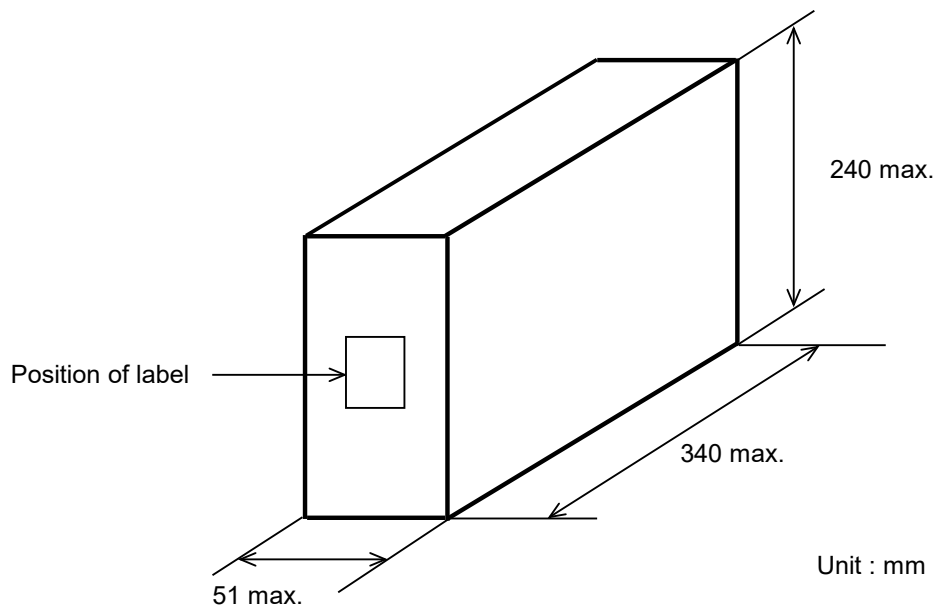

7. Taping specification

7-1. Dimension of capacitors on tape

Inside crimp taping type < Lead code : M1 >

Pitch of component 12.7mm / Lead spacing 5.0mm

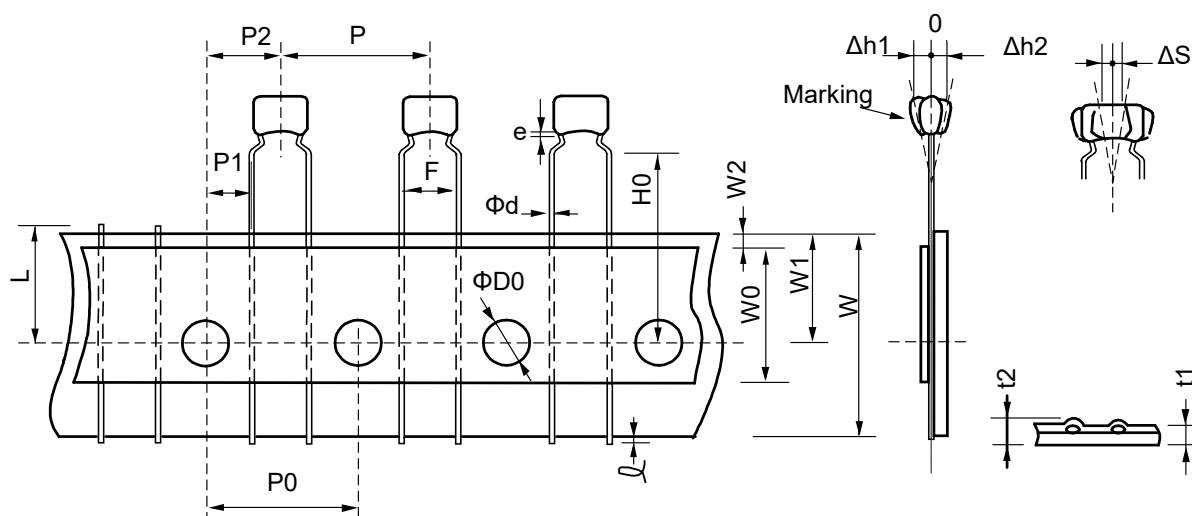

Unit : mm

Item	Code	Dimensions	Remarks
Pitch of component	P	12.7+/-1.0	
Pitch of sprocket hole	P0	12.7+/-0.2	
Lead spacing	F	5.0+0.6/-0.2	
Length from hole center to component center	P2	6.35+/-1.3	Deviation of progress direction
Length from hole center to lead	P1	3.85+/-0.7	
Deviation along tape, left or right defect	ΔS	0+/-2.0	They include deviation by lead bend
Carrier tape width	W	18.0+/-0.5	
Position of sprocket hole	W1	9.0+0/-0.5	Deviation of tape width direction
Lead distance between reference and bottom plane	H0	16.0+/-0.5	
Protrusion length	ℓ	0.5 max.	
Diameter of sprocket hole	ΦD0	4.0+/-0.1	
Lead diameter	Φd	0.5+/-0.05	
Total tape thickness	t1	0.6+/-0.3	They include hold down tape thickness
Total thickness of tape and lead wire	t2	1.5 max.	
Deviation across tape	Δh1	2.0 max. (Dimension code : W)	
	Δh2	1.0 max. (except as above)	
Portion to cut in case of defect	L	11.0+0/-1.0	
Hold down tape width	W0	9.5 min.	
Hold down tape position	W2	1.5+/-1.5	
Coating extension on lead	e	Up to the end of crimp	

Reference only

Outside crimp taping type < Lead code : S1 >
 Pitch of component 12.7mm / Lead spacing 2.5mm

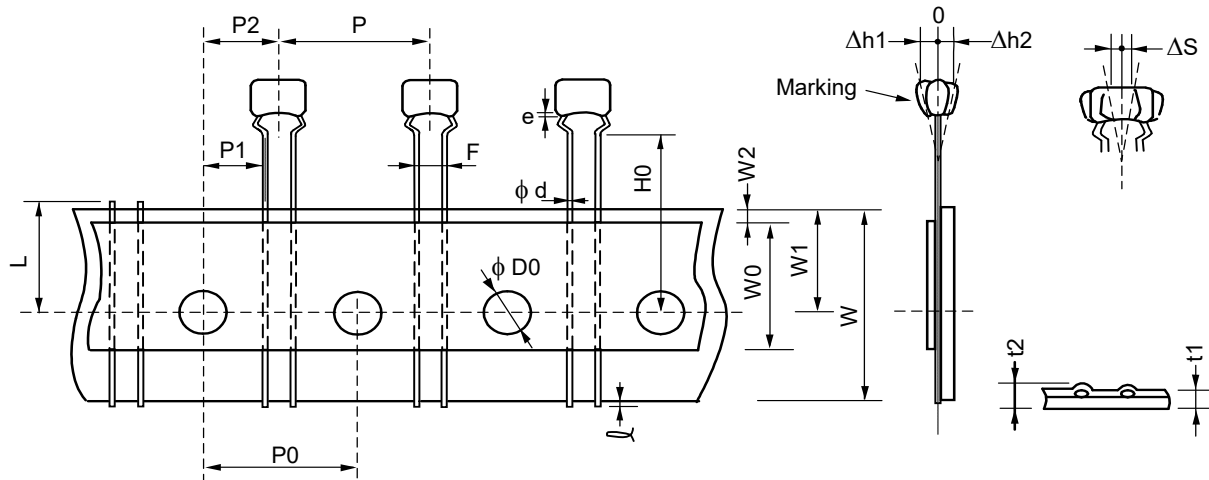

Unit : mm

Item	Code	Dimensions	Remarks
Pitch of component	P	12.7+/-1.0	
Pitch of sprocket hole	P0	12.7+/-0.2	
Lead spacing	F	2.5+0.4/-0.2	
Length from hole center to component center	P2	6.35+/-1.3	Deviation of progress direction
Length from hole center to lead	P1	3.85+/-0.7	
Deviation along tape, left or right defect	ΔS	0+/-2.0	They include deviation by lead bend
Carrier tape width	W	18.0+/-0.5	
Position of sprocket hole	W1	9.0+0/-0.5	Deviation of tape width direction
Lead distance between reference and bottom plane	H0	16.0+/-0.5	
Protrusion length	l	0.5 max.	
Diameter of sprocket hole	$\Phi D0$	4.0+/-0.1	
Lead diameter	Φd	0.5+/-0.05	
Total tape thickness	t1	0.6+/-0.3	They include hold down tape thickness
Total thickness of tape and lead wire	t2	1.5 max.	
Deviation across tape	$\Delta h1$	1.0 max.	
	$\Delta h2$		
Portion to cut in case of defect	L	11.0+0/-1.0	
Hold down tape width	W0	9.5 min.	
Hold down tape position	W2	1.5+/-1.5	
Coating extension on lead	e	Up to the end of crimp	

7-2. Splicing way of tape

1) Adhesive force of tape is over 3N at test condition as below.

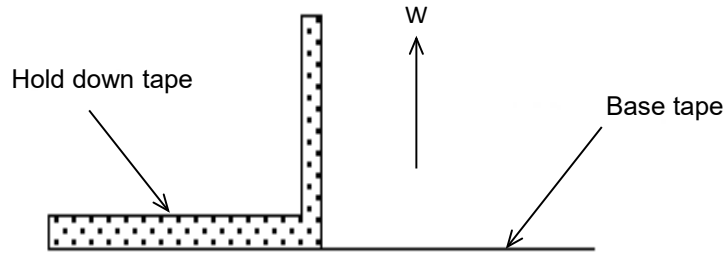

2) Splicing of tape

a) When base tape is spliced

- Base tape shall be spliced by cellophane tape.
(Total tape thickness shall be less than 1.05mm.)

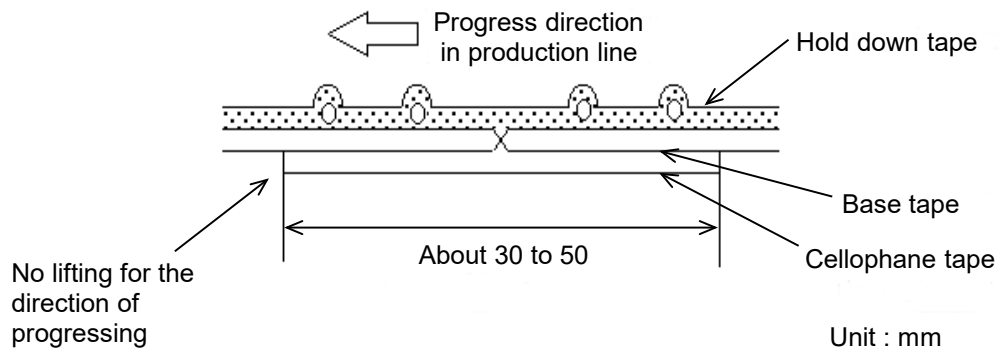

b) When hold down tape is spliced

- Hold down tape shall be spliced with overlapping.
(Total tape thickness shall be less than 1.05mm.)

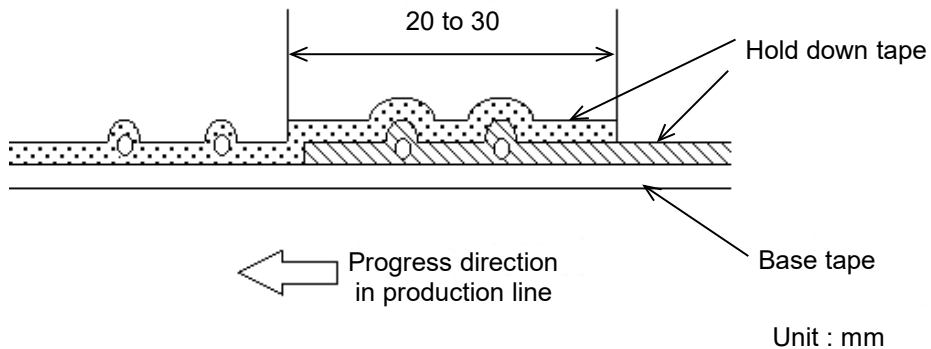

c) When both tape are spliced

- Base tape and hold down tape shall be spliced with splicing tape.