

Product Summary (@T_A = +25°C)

V _{RRM} (V)	I _o (A)	V _F Max (V)	I _R Max (mA)
45	10	0.47	0.28

Description and Applications

Packaged in the compact thermally efficient PowerDI[®]5 package, the SBR10E45P5 provides ultra-low forward-voltage drop (V_F) and excellent low reverse leakage stability at high temperatures. It is ideal for use as a rectification, freewheeling or polarity protection diode in applications such as:

- >10W AC-DC Adaptors/Chargers
- DC-DC Converters

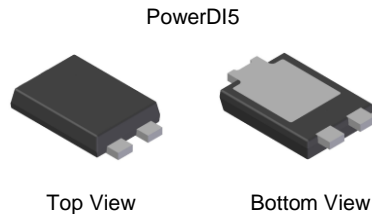

Features and Benefits

- Patented Super Barrier Rectifier SBR[®] Technology
- Ultra Low Forward Voltage Drop (V_F) Helps Minimize Power Losses
- Excellent Reverse Leakage (I_R) Stability at Higher Temperatures
- Thermally Efficient Package for Cooler Running Applications
- Less than 1.1mm Package Profile Ideal for Thin Applications
- Lead-Free Finish; RoHS Compliant (Notes 1 & 2)**
- Halogen and Antimony Free. "Green" Device (Note 3)**
- For automotive applications requiring specific change control (i.e. parts qualified to AEC-Q100/101/200, PPAP capable, and manufactured in IATF 16949 certified facilities), please [contact us](mailto:contact_us) or your local Diodes representative. <https://www.diodes.com/quality/product-definitions/>**

Mechanical Data

- Package: PowerDI5
- Package Material: Molded Plastic, "Green" Molding Compound. UL Flammability Classification Rating 94V-0
- Moisture Sensitivity: Level 1 per J-STD-020
- Terminals: Matte Tin Finish Annealed over Copper Leadframe; Solderable per MIL-STD-202, Method 208 (e3)
- Terminal Connections: See Diagram Below
- Weight: 0.093 grams (Approximate)

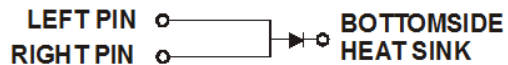

Note: Pins Left & Right must be electrically connected at the printed circuit board.

Ordering Information (Note 4)

Part Number	Package	Packing	
		Qty.	Carrier
SBR10E45P5-13	PowerDI5	5,000	Tape & Reel
SBR10E45P5-13D (Note 5)	PowerDI5	5,000	Tape & Reel
SBR10E45P5-7	PowerDI5	1,500	Tape & Reel

- Notes:
- EU Directive 2002/95/EC (RoHS), 2011/65/EU (RoHS 2) & 2015/863/EU (RoHS 3) compliant. All applicable RoHS exemptions applied.
 - See <https://www.diodes.com/quality/lead-free/> for more information about Diodes Incorporated's definitions of Halogen- and Antimony-free, "Green" and Lead-free.
 - Halogen- and Antimony-free "Green" products are defined as those which contain <900ppm bromine, <900ppm chlorine (<1500ppm total Br + Cl) and <1000ppm antimony compounds.
 - For packaging details, go to our website at <https://www.diodes.com/design/support/packaging/diodes-packaging/>.
 - PowerDI5 available in 5K quantity on 13-inch reel & 12mm tape, part number suffix "13D"; 1.5K quantity on 7-inch reel, part number suffix "7".

Marking Information

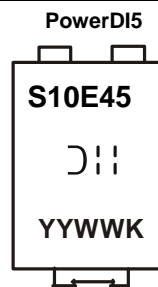

S10E45 = Product Type Marking Code
 YYWW = Date Code Marking
 YY = Last Two Digits of Year (ex: 21 = 2021)
 WW = Week (01 to 53)
 K = Factory Designator

Maximum Ratings (@T_A = +25°C, unless otherwise specified.)

Characteristic	Symbol	Value	Unit
Peak Repetitive Reverse Voltage Working Peak Reverse Voltage DC Blocking Voltage	V _{RRM}	45	V
Average Rectified Output Current	I _O	10	A
Non-Repetitive Peak Forward Surge Current 8.3mS	I _{FSM}	275	A

Parameter	Symbol	Value	Unit
Human Body Model ESD Protection	ESD HBM	8	kV
Machine Model ESD Protection	ESD MM	400	V

Caution: Stresses greater than the 'Absolute Maximum Ratings' specified above may cause permanent damage to the device. These are stress ratings only; functional operation of the device at these or any other conditions exceeding those indicated in this specification is not implied. Device reliability may be affected by exposure to absolute maximum rating conditions for extended periods of time.

Semiconductor devices are ESD sensitive and may be damaged by exposure to ESD events. Suitable ESD precautions should be taken when handling and transporting these devices

Thermal Characteristics

Characteristic	Symbol	Value	Unit
Typical Thermal Resistance Junction to Ambient (Note 6)	R _{θJA}	88	°C/W
Typical Thermal Resistance Junction to Case (Note 6)	R _{θJC}	14	°C/W
Operating and Storage Temperature Range	T _J , T _{STG}	-55 to +150	°C

Electrical Characteristics (@T_A = +25°C, unless otherwise specified.)

Characteristic	Symbol	Min	Typ	Max	Unit	Test Condition
Forward Voltage Drop	V _F	—	0.42	0.47	V	I _F = 10A, T _A = +25°C
		—	0.38	0.41		I _F = 10A, T _A = +125°C
Leakage Current (Note 7)	I _R	—	0.05	0.28	mA	V _R = 45V, T _A = +25°C
		—	—	50		V _R = 45V, T _A = +125°C

Notes: 6. With 2inch*2inch Al board.
7. Short duration pulse test used to minimize self-heating effect.

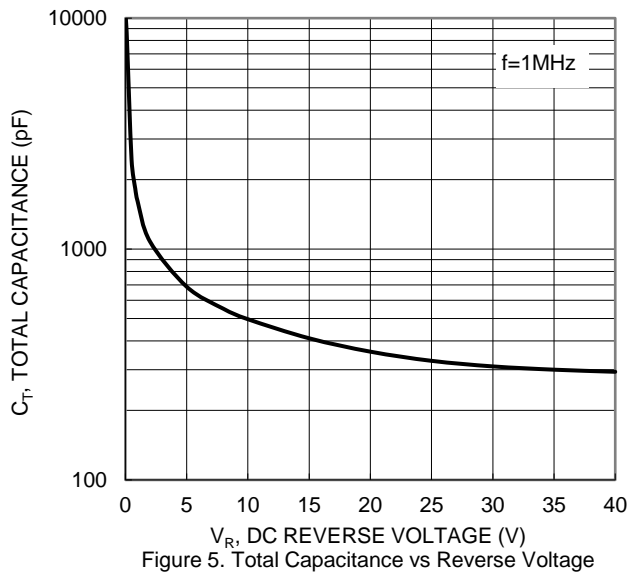
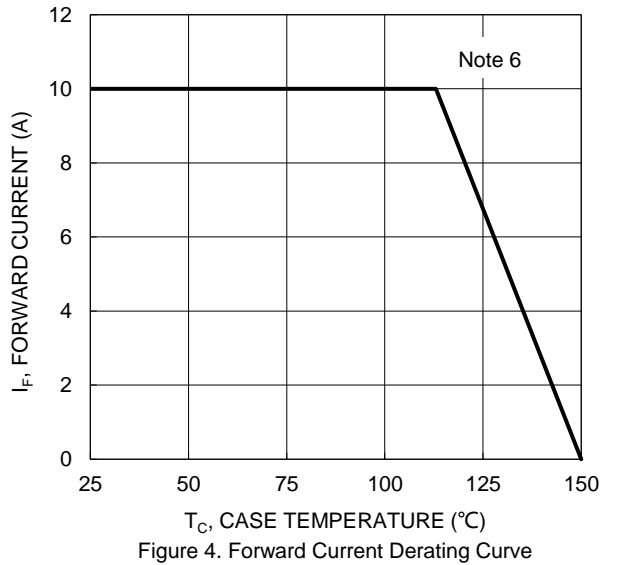
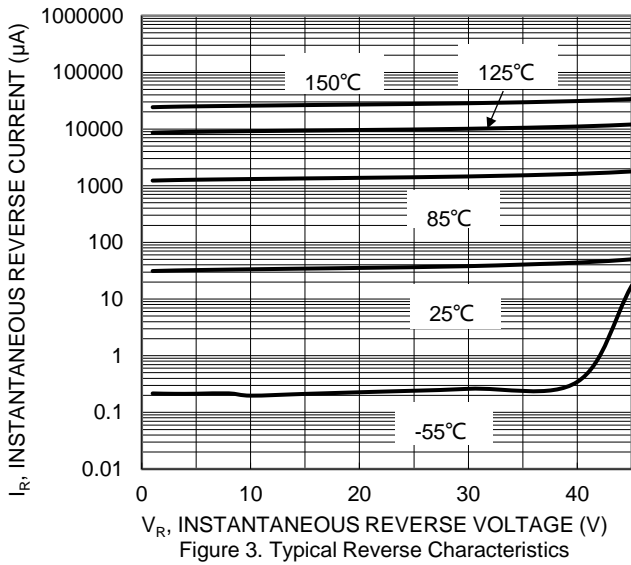
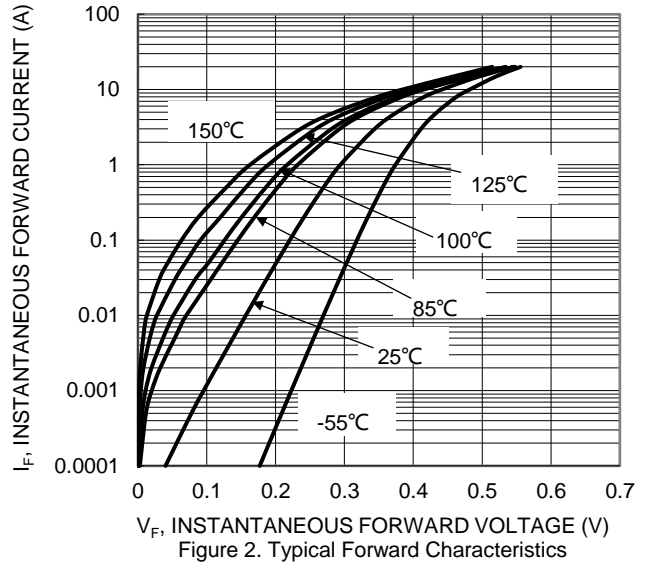
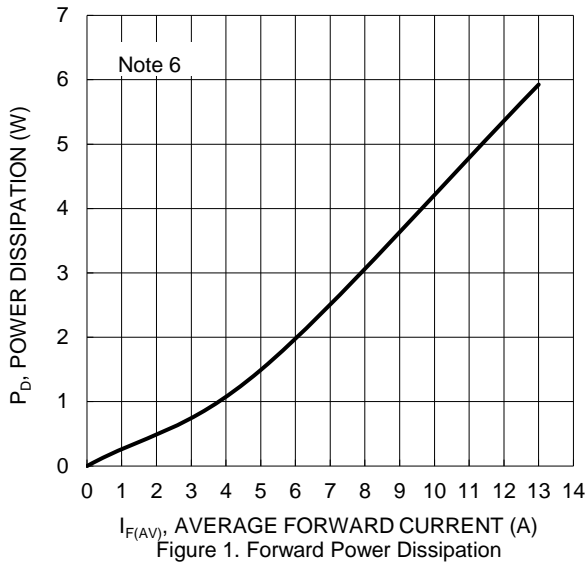

Package Outline Dimensions

Please see <http://www.diodes.com/package-outlines.html> for the latest version.

PowerDI5

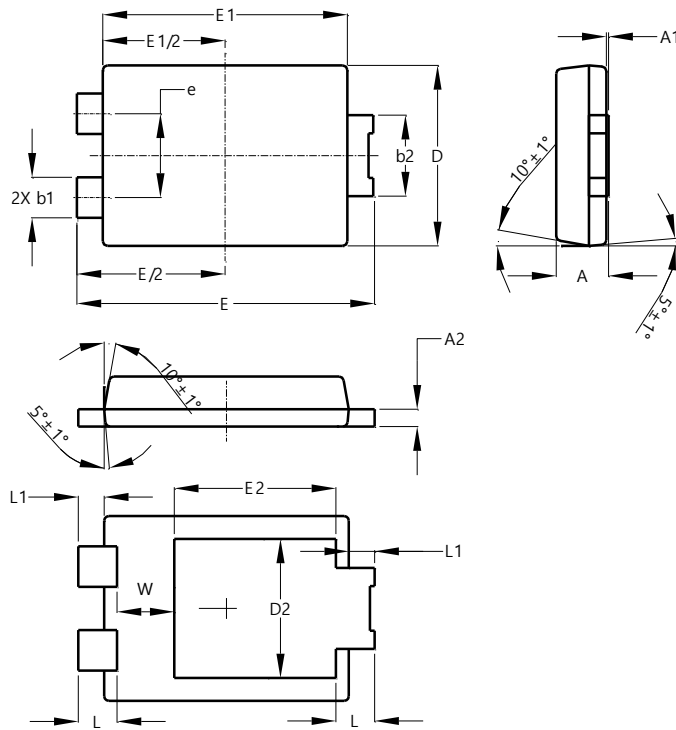

PowerDI5			
Dim	Min	Max	Typ
A	1.05	1.15	1.10
A1	0.00	0.05	--
A2	0.33	0.43	0.381
b1	0.80	0.99	0.89
b2	1.70	1.88	1.78
D	3.90	4.05	3.966
D2	--	--	3.054
E	6.40	6.60	6.51
e	--	--	1.84
E1	5.30	5.45	5.37
E2	--	--	3.549
L	0.75	0.95	0.85
L1	0.50	0.65	0.57
W	1.10	1.41	1.255
All Dimensions in mm			

Suggested Pad Layout

Please see <http://www.diodes.com/package-outlines.html> for the latest version.

PowerDI5

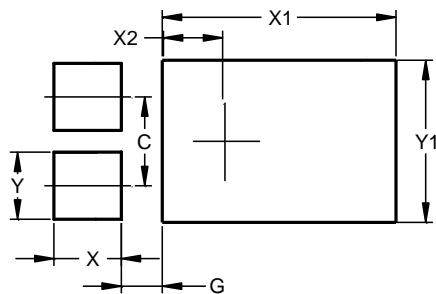

Dimensions	Value (in mm)
C	1.840
G	0.852
X	1.400
X1	4.860
X2	1.310
Y	1.390
Y1	3.360

IMPORTANT NOTICE

1. DIODES INCORPORATED AND ITS SUBSIDIARIES ("DIODES") MAKE NO WARRANTY OF ANY KIND, EXPRESS OR IMPLIED, WITH REGARDS TO ANY INFORMATION CONTAINED IN THIS DOCUMENT, INCLUDING, BUT NOT LIMITED TO, THE IMPLIED WARRANTIES OF MERCHANTABILITY, FITNESS FOR A PARTICULAR PURPOSE OR NON-INFRINGEMENT OF THIRD PARTY INTELLECTUAL PROPERTY RIGHTS (AND THEIR EQUIVALENTS UNDER THE LAWS OF ANY JURISDICTION).
2. The Information contained herein is for informational purpose only and is provided only to illustrate the operation of Diodes products described herein and application examples. Diodes does not assume any liability arising out of the application or use of this document or any product described herein. This document is intended for skilled and technically trained engineering customers and users who design with Diodes products. Diodes products may be used to facilitate safety-related applications; however, in all instances customers and users are responsible for (a) selecting the appropriate Diodes products for their applications, (b) evaluating the suitability of the Diodes products for their intended applications, (c) ensuring their applications, which incorporate Diodes products, comply the applicable legal and regulatory requirements as well as safety and functional-safety related standards, and (d) ensuring they design with appropriate safeguards (including testing, validation, quality control techniques, redundancy, malfunction prevention, and appropriate treatment for aging degradation) to minimize the risks associated with their applications.
3. Diodes assumes no liability for any application-related information, support, assistance or feedback that may be provided by Diodes from time to time. Any customer or user of this document or products described herein will assume all risks and liabilities associated with such use, and will hold Diodes and all companies whose products are represented herein or on Diodes' websites, harmless against all damages and liabilities.
4. Products described herein may be covered by one or more United States, international or foreign patents and pending patent applications. Product names and markings noted herein may also be covered by one or more United States, international or foreign trademarks and trademark applications. Diodes does not convey any license under any of its intellectual property rights or the rights of any third parties (including third parties whose products and services may be described in this document or on Diodes' website) under this document.
5. Diodes products are provided subject to Diodes' Standard Terms and Conditions of Sale (<https://www.diodes.com/about/company/terms-and-conditions/terms-and-conditions-of-sales/>) or other applicable terms. This document does not alter or expand the applicable warranties provided by Diodes. Diodes does not warrant or accept any liability whatsoever in respect of any products purchased through unauthorized sales channel.
6. Diodes products and technology may not be used for or incorporated into any products or systems whose manufacture, use or sale is prohibited under any applicable laws and regulations. Should customers or users use Diodes products in contravention of any applicable laws or regulations, or for any unintended or unauthorized application, customers and users will (a) be solely responsible for any damages, losses or penalties arising in connection therewith or as a result thereof, and (b) indemnify and hold Diodes and its representatives and agents harmless against any and all claims, damages, expenses, and attorney fees arising out of, directly or indirectly, any claim relating to any noncompliance with the applicable laws and regulations, as well as any unintended or unauthorized application.
7. While efforts have been made to ensure the information contained in this document is accurate, complete and current, it may contain technical inaccuracies, omissions and typographical errors. Diodes does not warrant that information contained in this document is error-free and Diodes is under no obligation to update or otherwise correct this information. Notwithstanding the foregoing, Diodes reserves the right to make modifications, enhancements, improvements, corrections or other changes without further notice to this document and any product described herein. This document is written in English but may be translated into multiple languages for reference. Only the English version of this document is the final and determinative format released by Diodes.
8. Any unauthorized copying, modification, distribution, transmission, display or other use of this document (or any portion hereof) is prohibited. Diodes assumes no responsibility for any losses incurred by the customers or users or any third parties arising from any such unauthorized use.

Copyright © 2021 Diodes Incorporated

www.diodes.com