

| | | | |
|---|------------------|--------------------|--------|
| Connector: RP-SMA Jack (Male Pin) | | | |
| Termination: PCB Edge Mount, 0.062" Thick | | | |
| Part Number | CONREVSMA003.062 | CONREVSMA003.062-G | |
| Connector Part | Material | Finish | Finish |
| Bodies | Body: Brass | Nickel | Gold |
| Center Contact | Pin: Brass | Gold | Gold |
| Insulator | PTFE | - | - |

| REVISIONS | | | |
|-----------|--|-----------|------|
| REV | DESCRIPTION | DATE | APPV |
| A | INITIAL RELEASE OF LINX INTERNAL DRAWING | 01/MAR/19 | CLL |

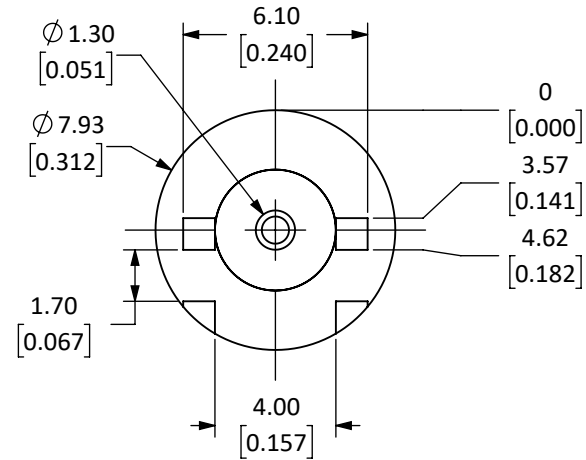
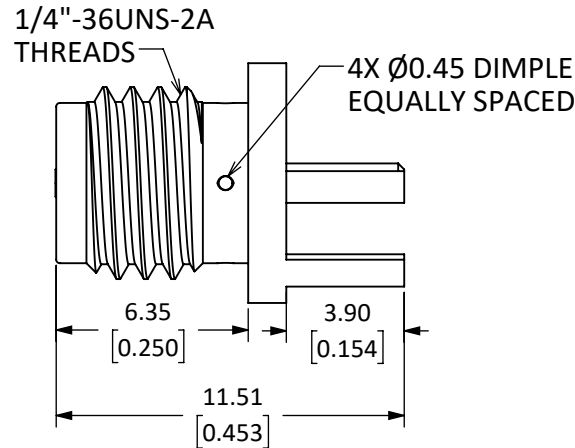

NOTES: (UNLESS OTHERWISE SPECIFIED)

1. ALL DIMENSIONS ARE IN mm [INCHES].
2. DIMENSIONS APPLY AFTER FINISHING.
3. MANUFACTURE TO BE COMPLIANT WITH EU RoHS DIRECTIVE, USE MATERIALS THAT DO NOT CONTAIN REACH SUBSTANCES OF VERY HIGH CONCERN >1000ppm, AND USE DRC CONFLICT-FREE SOURCED MATERIALS.
4. SAFETY BREAK ALL SHARP CORNERS AND EDGES 0.5 MAXIMUM.
5. SEE TABLE I FOR ELECTRICAL SPECIFICATIONS. (SHEET 2)
6. SEE TABLE II FOR ENVIRONMENTAL SPECIFICATIONS. (SHEET 2)
7. SEE TABLE III FOR MECHANICAL SPECIFICATIONS. (SHEET 2)
8. SEE PARTSLIST. "*" INDICATES FINISH TYPE.

WARNING: THIS DRAWING CONTAINS PROPRIETARY INFORMATION THAT IS THE SOLE PROPERTY OF LINX TECHNOLOGIES, AND SHALL BE TREATED AS SUCH. NO DISCLOSURE OR REPRODUCTION OF THIS DOCUMENT IS PERMITTED, IN WHOLE OR IN PART, WITHOUT THE EXPRESS WRITTEN PERMISSION OF LINX TECHNOLOGIES OR ITS DESIGNATED AGENTS.

| | | |
|-----------|--|--|
| MATERIAL: | TOLERANCES: 0.50 [.020]-5.00 [.200]= ±0.20 [.008] 5.00 [.200]-30.00 [1.200]= ±0.40 [.016] 30.0 [1.20]-120.0 [4.75]= ±0.60 [0.24] 120.0 [4.75]-315.0 [12.40]= ±1.0 [.040] | PROJECTION:  |
| FINISH: | DRAWN: M. SCHULTE | DT: 21/JAN/19 |
| | ENGR: D. VARATHARAJAN | DT: 08/MAR/19 |

| | | | |
|--|----------------------|----------------------------------|--|
| Linx | | 159 ORT LANE MERLIN, OR 97532 | |
| TITLE: RP-SMA FEMALE EDGE MOUNT FOR 0.062" THICK BOARD | | | |
| SIZE | DWG. NO. | REV | |
| A | CONREVSMA003.062-* | A | |
| SCALE: 4:1 | DO NOT SCALE DRAWING | SHEET 1 OF 2 | |

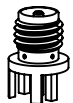

SCALE 1 : 1

5 TABLE I

| Electrical Data | Detail |
|-----------------------|--|
| Impedance | 50 Ω |
| Frequency Range | 0 to 18 GHz |
| Insulation Resistance | 5 000 M Ω min. |
| Voltage Rating | 500 V RMS |
| Contact Resistance | Center: ≤ 2.0 m Ω Outer: ≤ 2.0 m Ω |
| VSWR | $\leq 1.2 : 1$ @ 6 GHz |

6 TABLE II

| Environmental Data | Detail |
|--------------------------|---|
| Corrosion (Salt spray) | ASTM B-117 |
| Thermal Shock | MIL-STD-202 Method 107 test condition B |
| Vibration | MIL-STD-202 Method 204 test condition D |
| Mechanical Shock | MIL-STD-202 Method 213 test condition I |
| Temperature Range | -65 $^{\circ}$ C to +165 $^{\circ}$ C |
| Environmental Compliance | RoHS |

7 TABLE III

| Mechanical Data | Detail |
|------------------------|----------------------------|
| Mounting Type | PCB Board Edge, End Launch |
| Fastening Type | 1/4"-36 Threaded Coupling |
| Recommended Torque | 0.57 N·m (5.0 in·lbs) |
| Coupling Nut Retention | 60 lbs. min. |
| Connector Durability | 500 cycles min. |
| Weight | 1.24 g (0.04 oz) |

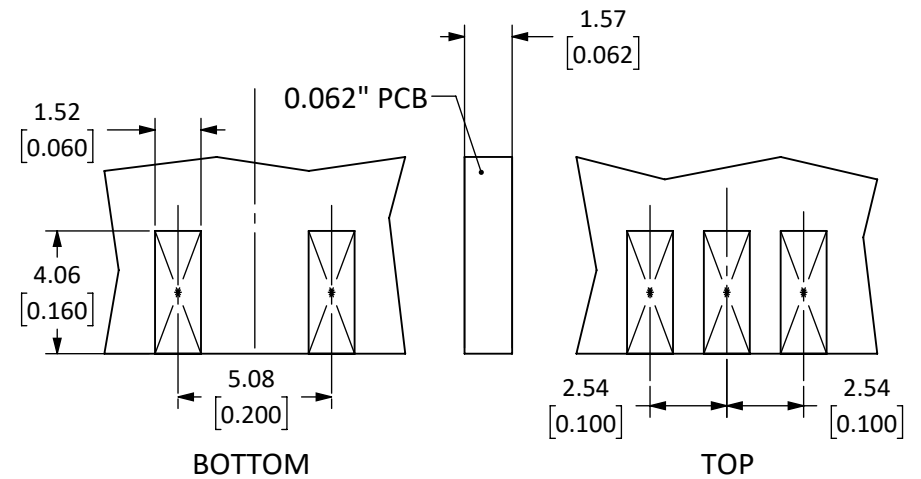

RECOMMENDED FOOTPRINT

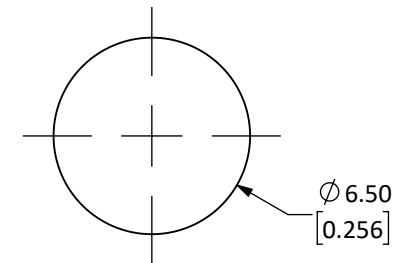

RECOMMENDED MOUNTING HOLE

| SIZE | DWG. NO. | REV |
|------------|----------------------|--------------|
| A | CONREVSMA003.062-* | A |
| SCALE: 4:1 | DO NOT SCALE DRAWING | SHEET 2 OF 2 |

Reflow Soldering

Reflow soldering is the most common method of attaching surface mount electronic components to a circuit board. The goal of the reflow process is to melt the solder and heat the conductive surfaces, without overheating or damaging any electrical components. In the conventional reflow soldering process, there are four distinct stages, or zones, having specific thermal profiles: preheat, thermal soak, reflow, and cooling. For high-volume assembly, surface mount components are generally auto-placed by machine.

Reflow Temperature Profile

The single most critical stage in the automated assembly process is the reflow stage. The reflow profile for any given component should be closely followed because excessive temperatures or transport times during reflow can irreparably damage the component. Assembly personnel need to pay careful attention to the oven's profile to ensure that it meets the requirements necessary to successfully reflow all components while still remaining within the limits mandated by components requiring shorter flow periods.

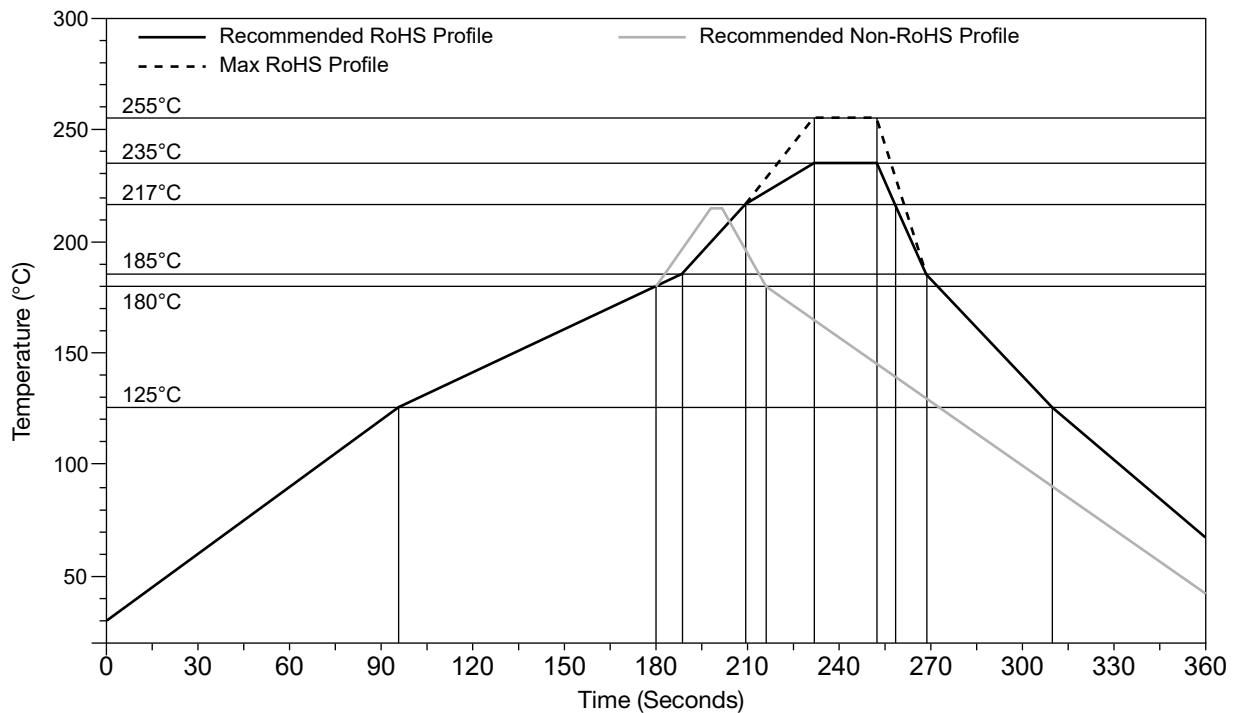

Mouser Electronics

Authorized Distributor

Click to View Pricing, Inventory, Delivery & Lifecycle Information:

[Linx Technologies:](#)

[CONREVSMA003.062](#)