

FEATURES

- RS-232 and RS-422 on One Chip
- Single +5 V Supply
- 0.1 μ F Capacitors
- Short Circuit Protection
- Excellent Noise Immunity
- Low Power BiCMOS Technology
- High Speed, Low Skew RS-422 Operation
- 40°C to +85°C Operations

APPLICATIONS

- DTE-DCE Interface
- Packet Switching
- Local Area Networks
- Data Concentration
- Data Multiplexers
- Integrated Services Digital Network (ISDN)

GENERAL DESCRIPTION

The AD7306 line driver/receiver is a 5 V monolithic product which provides an interface between TTL signal levels and dual standard EIA RS-232/RS-422 signal levels. The part contains two RS-232 drivers, one RS-422 driver, one RS-232 receiver, and one receiver path which can be configured either as RS-232 or as RS-422.

An internal charge pump voltage converter facilitates operation from a single +5 V power supply. The internal charge pump generates ± 10 V levels allowing RS-232 output levels to be developed without the need for external bipolar power supplies.

A highly efficient charge pump design allows operation using non polarized, miniature 0.1 μ F capacitors. This gives a considerable saving in printed circuit board space over conventional products which can use up to 10 μ F capacitors. The charge pump output voltages may also be used to power external circuitry which requires dual supplies.

FUNCTIONAL BLOCK DIAGRAM

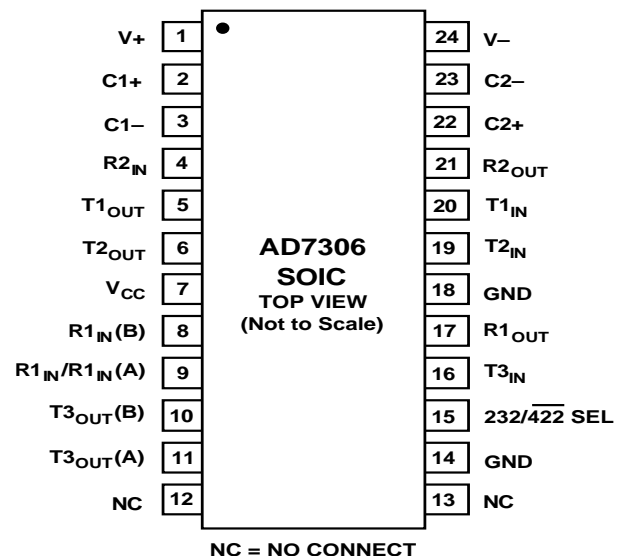

The RS-232 channels are suitable for communications rates up to 100 kHz and the RS-422 channels are suitable for high speed communications up to 5 MHz. The RS-422 transmitter complementary outputs are closely matched and feature low timing skew between the complementary outputs. This is often an essential requirement to meet tight system timing specifications.

All inputs feature ESD protection, all driver outputs feature high source and sink current capability and are internally protected against short circuits on the outputs. An epitaxial layer is used to guard against latch-up.

The part is available in a 24-lead SOIC and 24-pin plastic DIP package.

AD7306—SPECIFICATIONS ($V_{CC} = +5\text{ V} \pm 5\%$, $C1 = C2 = C3 = C4 = 0.1\ \mu\text{F}$. All specifications T_{MIN} to T_{MAX} unless otherwise noted.)

| Parameter | Min | Typ | Max | Units | Test Conditions/Comments |
|--|---------|----------|----------|------------------|---|
| RS-232 DRIVER | | | | | |
| TTL Input Logic Low, V_{INL} | | | 0.8 | V | |
| TTL Input Logic High, V_{INH} | 2.0 | | | V | |
| Input Logic Current | | 0.1 | ± 10 | μA | $V_{IN} = 0\text{ V to }V_{CC}$ |
| RS-232 High Level Output Voltage | 5.0 | 7.3 | | V | $R_L = 3\text{ k}\Omega$ |
| RS-232 Low Level Output Voltage | -5.0 | -6.5 | | V | $R_L = 3\text{ k}\Omega$ |
| Output Short Circuit Current | ± 5 | ± 12 | | mA | $V_{OUT} = 0\text{ V}$, $T_A = 0^\circ\text{C to }+70^\circ\text{C}$ |
| Slew Rate | 8 | 20 | 30 | V/ μs | $C_L = 50\text{ pF}$, $R_L = 3\text{ k}\Omega$ |
| | | 4 | | V/ μs | $C_L = 2500\text{ pF}$, $R_L = 3\text{ k}\Omega$ |
| Output Resistance (Powered Down) | 300 | 10M | | Ω | $V_{CC} = 0\text{ V}$, $V_{OUT} = \pm 3\text{ V}$ |
| RS-232 RECEIVER | | | | | |
| Input Voltage Range | -15 | | +15 | V | |
| RS-232 Input Threshold Low | 0.8 | 1.3 | | V | |
| RS-232 Input Threshold High | | 1.7 | 2.4 | V | |
| RS-232 Input Hysteresis | 0.1 | 0.4 | 1.0 | V | |
| RS-232 Input Resistance | 3 | 5 | 7 | k Ω | |
| TTL Output Voltage Low, V_{OL} | | 0.2 | 0.4 | V | $I_{OUT} = +4\text{ mA}$ |
| TTL Output Voltage High, V_{OH} | 3.5 | 4.8 | | V | $I_{OUT} = -4\text{ mA}$ |
| RS-422 DRIVER | | | | | |
| TTL Input Logic Low, V_{INL} | | | 0.8 | V | |
| TTL Input Logic High, V_{INH} | 2.0 | | | V | |
| Logic Input Current | | 0.1 | ± 10 | μA | $V_{IN} = 0\text{ V to }V_{CC}$ |
| Differential Output Voltage | 2 | | 5.0 | V | $V_{CC} = 5\text{ V}$, $R_L\text{ Diff} = \infty$; Figure 3 |
| | | | 3 | V | $R_L\text{ Diff} = 100\ \Omega$; Figure 3 |
| Common-Mode Output Voltage | | | 3 | V | |
| $\Delta V_{OUT} $ for Complementary O/P States | | | 0.2 | V | $R_L\text{ Diff} = 100\ \Omega$ |
| Output Short Circuit Current | 35 | | 150 | mA | $0\text{ V} \leq V_{CMR} \leq +7\text{ V}$ |
| RS-422 RECEIVER | | | | | |
| Common-Mode Voltage Range | | | ± 7 | V | Typical RS-422 Input Voltage $< 5\text{ V}$ |
| Differential Input Threshold Voltage | -0.2 | | +0.2 | V | |
| Input Voltage Hysteresis | | 70 | | mV | $V_{CM} = 0\text{ V}$ |
| Input Resistance | 3 | 5 | 7 | k Ω | |
| TTL Output Voltage Low, V_{OL} | | 0.2 | 0.4 | V | $I_{OUT} = +4.0\text{ mA}$ |
| TTL Output Voltage High, V_{OH} | 3.5 | 4.8 | | V | $I_{OUT} = -4.0\text{ mA}$ |
| 232/422 SEL Input | | | | | |
| Input Logic Low, V_{INL} | | | 0.8 | V | |
| Input Logic High, V_{INH} | 2.0 | | | V | |
| Logic Input Current | | 0.1 | ± 10 | μA | $V_{IN} = 0\text{ V to }V_{CC}$ |
| POWER SUPPLY CURRENT | | | | | |
| I_{CC} | | 10 | 15 | mA | Outputs Unloaded |
| CHARGE PUMP VOLTAGE GENERATOR | | | | | |
| V+ Output Voltage | | 9 | | V | RS-232 Output Unloaded; See Typical Performance Curves |
| V- Output Voltage | | -9 | | V | RS-232 Outputs Unloaded; See Typical Performance Curves |
| Generator Rise Time | | 200 | | μs | |

Specifications subject to change without notice.

TIMING SPECIFICATIONS ($V_{CC} = +5\text{ V} \pm 5\%$, $C_1 = C_2 = C_3 = C_4 = 0.1\ \mu\text{F}$. All specifications T_{MIN} to T_{MAX} unless otherwise noted.)

| Parameter | Typ | Max | Units | Test Conditions/Comments |
|---|------|-----|-------|---|
| RS-422 Driver | | | | |
| Propagation Delay Input to Output T_{PLH} , T_{PHL} | 35 | 100 | ns | R_L Diff = 100 Ω . $C_{L1} = C_{L2} = 100\text{ pF}$, Figures 2 & 4 |
| RS-422 O/P to O/P T_{SKEW} | 2 | 10 | ns | R_L Diff = 100 Ω . $C_{L1} = C_{L2} = 100\text{ pF}$, Figures 2 & 4 |
| Driver Rise/Fall Time T_R , T_F | 15 | 40 | ns | R_L Diff = 100 Ω . $C_{L1} = C_{L2} = 100\text{ pF}$, Figures 2 & 4 |
| RS-422 Receiver | | | | |
| Propagation Delay Input to Output T_{PLH} , T_{PHL} | 70 | 200 | ns | $C_L = 15\text{ pF}$. Figure 5 |
| RS-232/RS-422 Enable | | | | |
| RS-232 Disable to RS-422 Enable T_{EN1} | 70 | 200 | ns | Figure 6 |
| RS-422 Disable to RS-232 Enable T_{EN2} | 70 | 200 | ns | Figure 6 |
| Transmission Rate (RS-422) | 5 | | MHz | |
| RS-232 Receiver | | | | |
| Propagation Delay Input to Output | 1000 | | ns | |
| Transmission Rate (RS-232) | 100 | | kHz | $C_L = 50\text{ pF}$ |
| | 20 | | kHz | $C_L = 2.5\text{ nF}$ |

ABSOLUTE MAXIMUM RATINGS*

($T_A = +25^\circ\text{C}$ unless otherwise noted)

| | |
|--------------------------|--|
| V_{CC} | +7 V |
| V_+ | ($V_{CC} - 0.3\text{ V}$) to +13.2 V |
| V_- | +0.3 V to -13.2 V |
| Inputs | |
| $T1_{IN}$, $T2_{IN}$ | V_- to V_+ |
| $T3_{IN}$ | -0.3 V to V_+ |
| $R1_{IN}$ A/B, $R2_{IN}$ | -25 V to +25 V |
| 232/422 SEL | -0.3 V to V_+ |
| Outputs | |
| $T1_{OUT}$, $T2_{OUT}$ | -15 V to +15 V |
| $T3_{OUT}$ (A), (B) | -0.3 V to +7 V |
| $R1_{OUT}$, $R2_{OUT}$ | -0.3 V to ($V_{CC} + 0.3\text{ V}$) |

Short Circuit Duration

| | |
|---------------------------------------|---|
| T_{OUT} | Continuous |
| Power Dissipation | |
| Small Outline | 650 mW |
| DIP | 650 mW |
| Operating Temperature Range | |
| Commercial (J Version) | 0°C to $+70^\circ\text{C}$ |
| Industrial (A Version) | -40°C to $+85^\circ\text{C}$ |
| Storage Temperature Range | -65°C to $+150^\circ\text{C}$ |
| Lead Temperature (Soldering, 10 secs) | $+300^\circ\text{C}$ |

*Stresses above those listed under "Absolute Maximum Ratings" may cause permanent damage to the device. This is a stress rating only and functional operation of the device at these or any other conditions above those listed in the operational sections of this specification is not implied. Exposure to absolute maximum ratings for extended periods of time may affect device reliability.

CAUTION

ESD (electrostatic discharge) sensitive device. Electrostatic charges as high as 4000 V readily accumulate on the human body and test equipment and can discharge without detection. Although the AD7306 features proprietary ESD protection circuitry, permanent damage may occur on devices subjected to high energy electrostatic discharges. Therefore, proper ESD precautions are recommended to avoid performance degradation or loss of functionality.



PIN FUNCTION DESCRIPTION

| SOIC Pin | DIP Pin | Mnemonic | Function |
|----------|---------|--|---|
| 1 | 19 | V+ | Internally Generated Positive Supply (+9 V nominal). A 0.1 μ F capacitor must be connected between this pin and GND. |
| 2, 3 | 20, 22 | C1+, C1- | External Capacitor 1 Terminals. A 0.1 μ F capacitor must be connected between these pins. |
| 4 | 23 | R2 _{IN} | RS-232 Receiver R2 Input. This input accepts RS-232 input voltages. |
| 5 | 24 | T1 _{OUT} | RS-232 Transmitter (Driver) T1 Output (Typically ± 7.5 V). |
| 6 | 1 | T2 _{OUT} | RS-232 Transmitter (Driver) T2 Output (Typically ± 7.5 V). |
| 7 | 2 | V _{CC} | Power Supply Input (5 V \pm 5%). |
| 8 | 3 | R1 _{IN} (B) | RS-422 Receiver R1, Differential Input B. |
| 9 | 4 | R1 _{IN} /R1 _{IN} (A) | Receiver R1 Input. May be configured to accept either single ended RS-232 levels or differential RS-422 levels. It is configured using the 232/422 SEL pin. |
| 10 | 5 | T3 _{OUT} (B) | RS-422 Transmitter (Driver) T3, Differential Output B. |
| 11 | 6 | T3 _{OUT} (A) | RS-422 Transmitter (Driver) T3, Differential Output A. |
| 12, 13 | 16, 21 | NC | No Connect Pins. |
| 14, 18 | 7, 11 | GND | Ground Pin. Must be connected to 0 V. |
| 15 | 8 | 232/422 SEL | Select Input. This input configures Receiver R1 to accept either RS-232 or RS-422 signal levels. A Logic 1 on this input selects 232 operation while a Logic 0 selects 422 operation. |
| 16 | 9 | T3 _{IN} | TTL/CMOS Input to the RS-422 Transmitter T3. |
| 17 | 10 | R1 _{OUT} | TTL/CMOS Output from Receiver R1. |
| 19 | 12 | T2 _{IN} | TTL/CMOS Input to RS-232 Transmitter T2. |
| 20 | 13 | T1 _{IN} | TTL/CMOS Input to RS-232 Transmitter T1. |
| 21 | 14 | R2 _{OUT} | TTL/CMOS Output from Receiver R2. |
| 22, 23 | 15, 17 | C2+, C2- | External Capacitor 2 Terminals. A 0.1 μ F capacitor must be connected between these pins. |
| 24 | 18 | V- | Internally Generated Negative Supply (-9 V nominal). A 0.1 μ F capacitor must be connected between this pin and GND. |

PIN CONFIGURATIONS

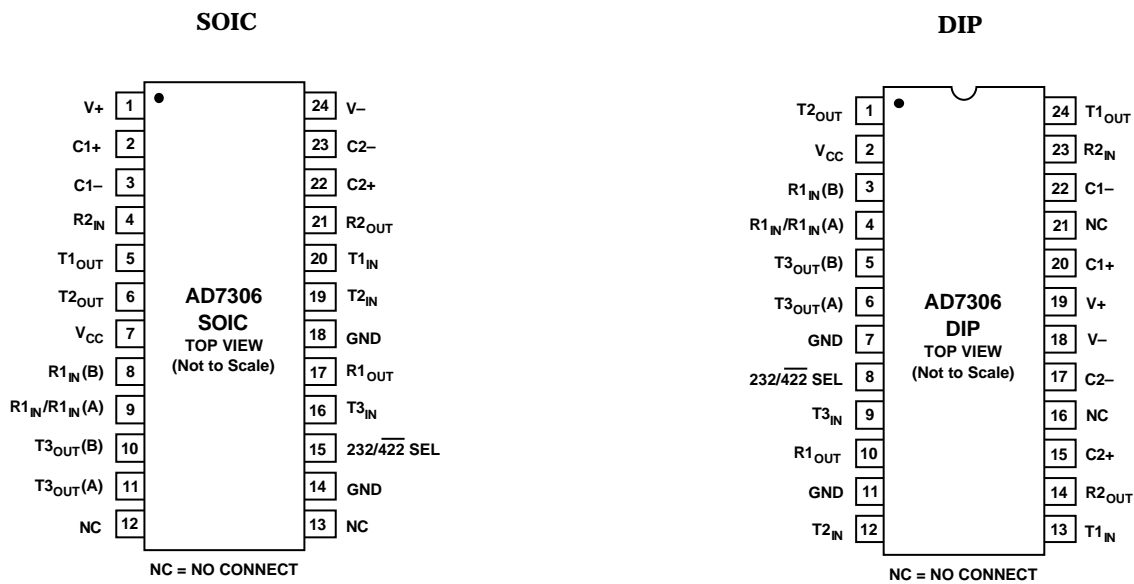

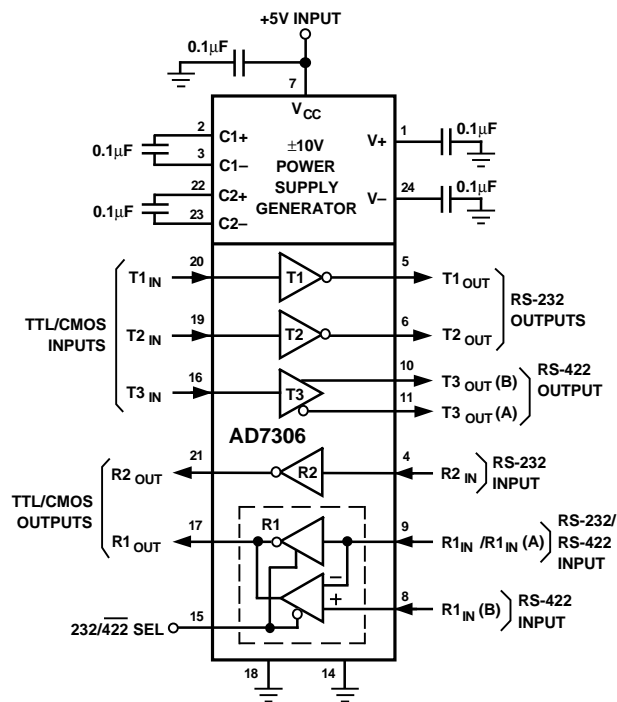

Figure 1. AD7306 Application Circuit

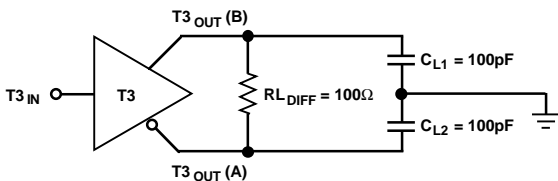

Figure 2. RS-422 Driver. Propagation Delay Test Circuit

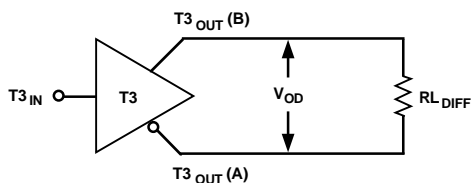

Figure 3. RS-422 Driver. Voltage Measurement Test Circuit

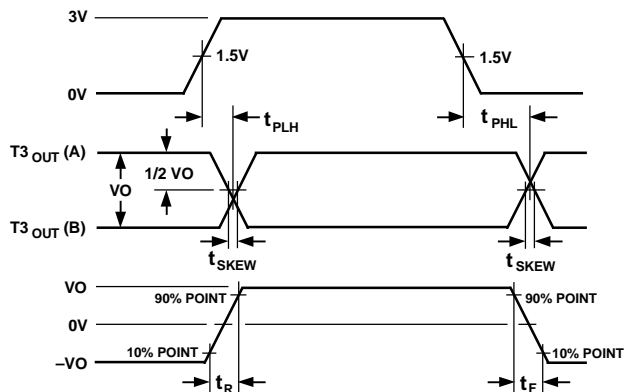

Figure 4. RS-422 Driver. Propagation Delay Rise/Fall Timing

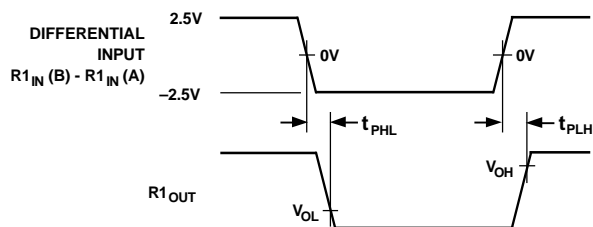

Figure 5. RS-422 Receiver Timing

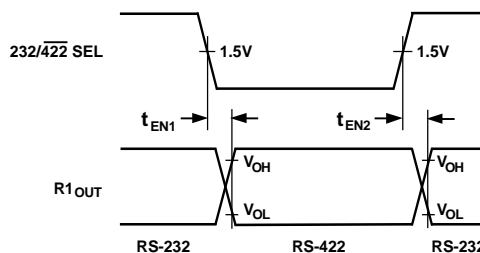

Figure 6. RS-232/RS-422 Receiver Enable Timing

AD7306

GENERAL DESCRIPTION

The AD7306 drivers/receivers provide an interface which is compatible with RS-232/RS-422 standard interfaces. As both standards are widely accepted it is often necessary to provide an interface which is compatible with both. The AD7306 is ideally suited to this type of application as both standards may be met using a single package. This part contains two RS-232 drivers, one RS-422 driver, one RS-232 receiver, and one receiver path which can be configured as either RS-232 or RS-422. This receiver is configured using the 232/422 SEL pin.

This part also contains an internal charge pump voltage converter which facilitates operation using a single +5 V power supply.

Charge Pump DC-DC Voltage Generator

The charge pump voltage generator uses a switched capacitor technique to develop ± 10 V levels from an input +5 V supply. A highly efficient charge pump design coupled with a high frequency internal oscillator permit operation using four 0.1 μ F capacitors.

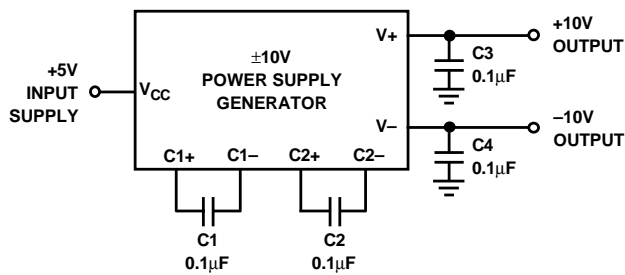

Figure 7. Charge Pump Voltage Generator

Capacitors C1 and C2 act as charge storage capacitors while C3 and C4 provide output smoothing. For correct operation all four capacitors must be included. Either polarized or nonpolarized capacitors may be used for C1–C4. If a polarized type is used, then the correct polarity should be observed. This may be ignored with nonpolarized type capacitors.

The charge pump output voltages, V+ and V–, are used internally to power the RS-232 transmitters. This permits RS-232 output levels to be developed on the RS-232 transmitter outputs. The charge pump output voltages may also be used to power external circuitry if the current requirements are small. Please refer to the Typical Performance Characteristics.

The generator rise time after power up is 200 μ s typical. This time is necessary to completely charge the storage capacitors in the charge pump. Therefore, RS-232 data transmission should not be initiated until this time has elapsed after switch on. This will ensure that valid data is always transmitted.

RS-232 Drivers

The RS-232 drivers in the AD7306 meet the EIA RS-232 specifications. The drivers are inverting level shifters which convert TTL/CMOS levels into RS-232 output levels. The input switching threshold is typically 1.3 V. With a typical RS-232 load, the output levels are ± 7.5 V. Under worst case load conditions, the drivers are guaranteed to provide ± 5 V which meets the minimum RS-232 requirement. The output slew rate is internally limited to <30 V/ μ s without the need for an external slew limiting capacitor. Short circuit protection is also provided which prevents damage in the event of output fault conditions. Active current limiting is used which limits the output short circuit current to less than 12 mA in the event of an output fault. This type of current limiting does not degrade the output voltage swing under normal loading conditions as would be the case with conventional passive limiting.

The powered-down output impedance is typically 10 M Ω . This is considerably larger than the 300 Ω minimum value required by the RS-232 specification. It provides additional protection under fault conditions where another powered-up transmitter output is inadvertently shorted to the powered-down device.

RS-232 Receivers

The receivers are inverting level shifters which accept RS-232 input levels (± 3 V to ± 15 V) and translates them into 5 V TTL/CMOS levels. The input switching thresholds are 0.8 V minimum and 2.4 V maximum which are well within the RS-232 requirement of ± 3 V. Internal 5 k Ω pull-down resistors to GND are provided on the receiver inputs. This ensures that an unconnected input will be interpreted as a low level giving a Logic “1” on the TTL/CMOS output. Excellent noise immunity is achieved by the use of hysteresis and internal filtering circuitry. The filter rejects noise glitches of up to 0.5 μ s in duration.

RS-422 Driver

The RS-422 driver on the AD7306 accepts a TTL/CMOS input and translates it into a differential RS-422 level signal. The input switching threshold is typically 1.3 V. The unloaded output differential voltage is typically ± 5 V (see Typical Performance Characteristics). Short circuit protection is provided on the output which limits the current to less than 150 mA.

RS-422 Receiver

The RS-422 receiver on the AD7306 accepts a differential input signal and translates it into a TTL/CMOS output level. The input resistance on both differential inputs is 5 k Ω typical. With the receiver inputs unconnected (floating), internal biasing ensures that the receiver output is a Logic “1.”

Excellent noise immunity and high transmission speed is achieved using the differential configuration.

Typical Performance Characteristics—AD7306

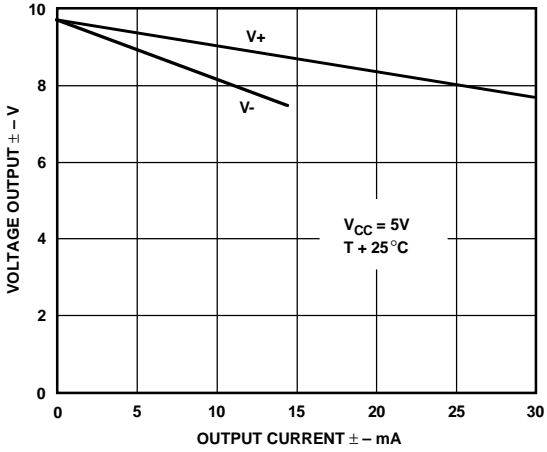

Figure 8. V_+ and V_- Voltage vs. Current

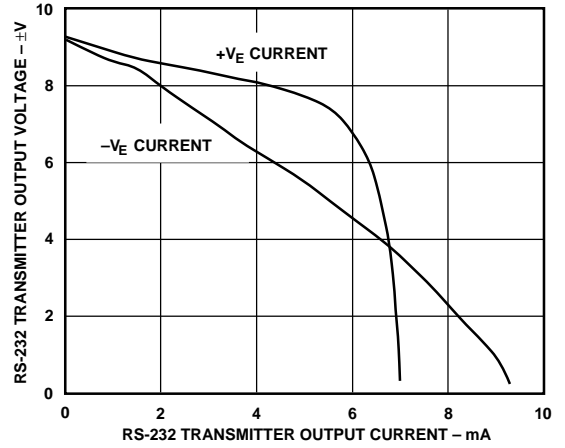

Figure 11. RS-232 Driver Output Voltage vs. Current

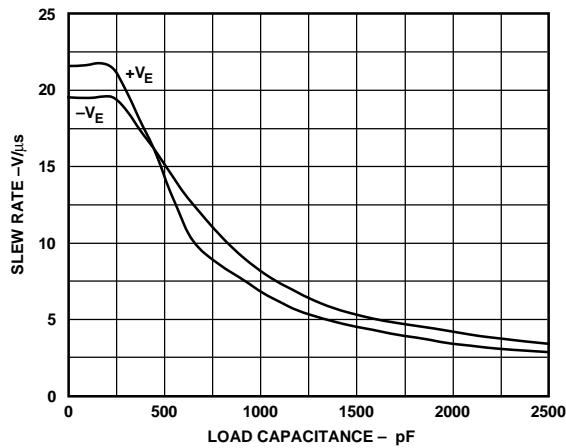

Figure 9. RS-232 Driver Slew Rate vs. Load Capacitance

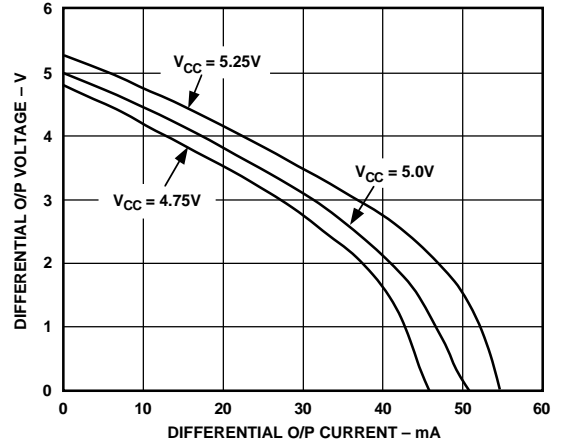

Figure 12. RS-422 Driver Output Current vs. Output Voltage

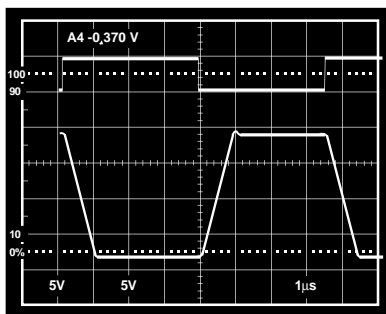

Figure 10. RS-232 Driver; $R_L = 5 \text{ k}\Omega$, $C_L = 50 \text{ pF}$

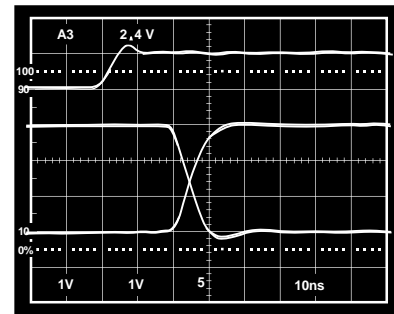

Figure 13. RS-422 Driver; $R_{L\text{DIFF}} = 100 \Omega$, $C_{L1} = C_{L2} = 100 \text{ pF}$

Single-Ended Data Transmission

Single-ended interfaces are used for low speed, short distance communications such as from a computer terminal to a printer. A single line is used to carry the signal. Various standards have been developed to standardize the communication link, the most popular of these being the RS-232. The RS-232 standard was introduced in 1962 by the EIA and has been widely used throughout the industry. The standard has been revised several times, and the current revision is known as EIA-232E. The RS-232 standard is suitable for single-ended data transmission at relatively slow data rates over short distances. A typical RS-232 interface is shown in Figure 14.

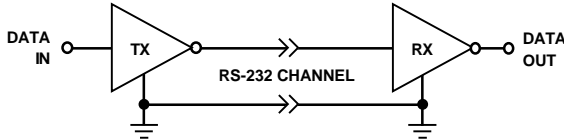

Figure 14. Single-Ended RS-232 Interface

Differential Data Transmission

When transmitting at high data rates, over long distances and through noisy environments, single-ended data transmission is often inadequate. In this type of application, differential data transmission offers superior performance. Differential transmission uses two signal lines to transmit data. It rejects ground shifts and is insensitive to noise signals which appear as common mode voltages on the transmission lines. To accommodate faster data communication, the differential RS-422 standard was developed. Therefore, it can be used to reliably transmit data at higher speeds and over longer distances than single-ended transmission. A typical RS-422 interface is shown in Figure 15.

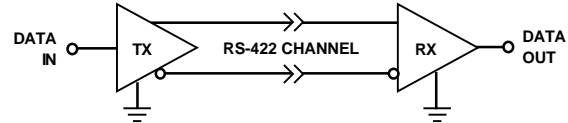
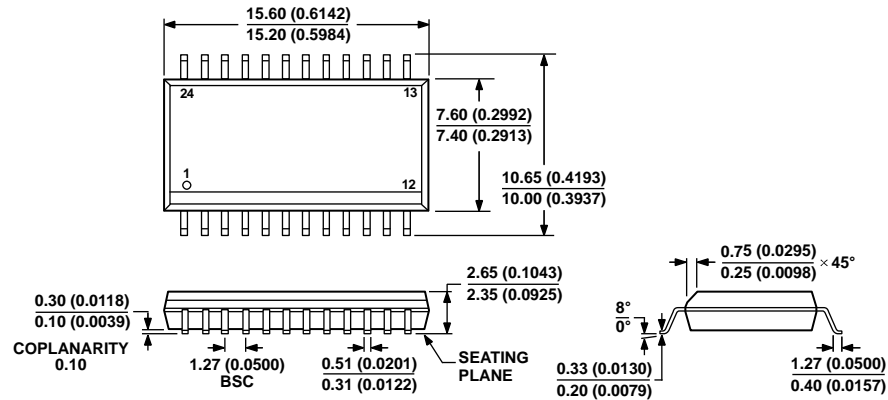

Figure 15. Differential RS-422 Interface

Table I. Comparison of RS-232 and RS-422 Interface Standards

| Specification | EIA-232E | RS-422 |
|-------------------------------|------------------------------|------------------|
| Transmission Type | Single-Ended | Differential |
| Maximum Data Rate | 20 kB/s | 10 MB/s |
| Maximum Cable Length | Load Dependent | 4000 ft. |
| Minimum Driver Output Voltage | ± 5 V | ± 1.5 V |
| Slew Rate | 30 V/ μ s max | |
| Receiver Input Resistance | 3 k Ω to 7 k Ω | 4 k Ω min |
| Receiver Input Sensitivity | ± 3 V | ± 200 mV |
| Receiver Input Voltage Range | ± 15 V | ± 7 V |
| No. of Drivers per Line | 1 | 1 |
| No. of Receivers per Line | 1 | 10 |

OUTLINE DIMENSIONS



COMPLIANT TO JEDEC STANDARDS MS-013-AD
 CONTROLLING DIMENSIONS ARE IN MILLIMETERS; INCH DIMENSIONS
 (IN PARENTHESES) ARE ROUNDED-OFF MILLIMETER EQUIVALENTS FOR
 REFERENCE ONLY AND ARE NOT APPROPRIATE FOR USE IN DESIGN.

Figure 16. 24-Lead Standard Small Outline Package [SOIC_W]
 Wide Body
 (RW-24)

Dimensions shown in millimeters and (inches)

12-09-2010-A

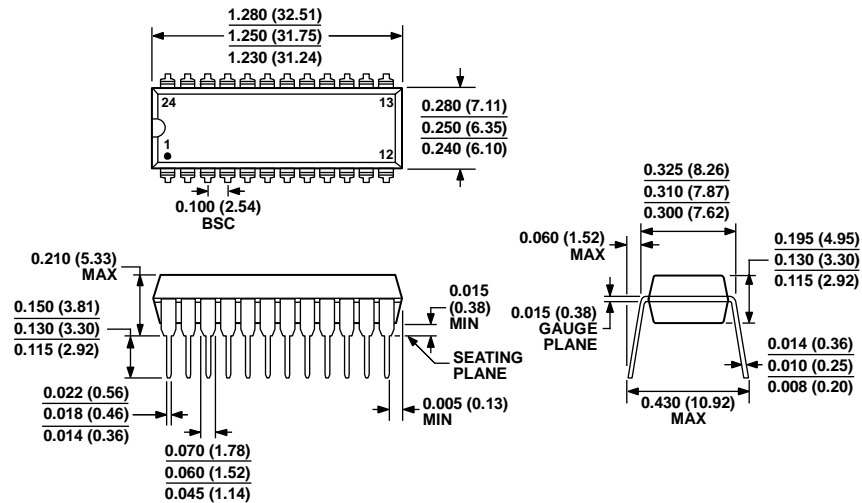

COMPLIANT TO JEDEC STANDARDS MS-001
 CONTROLLING DIMENSIONS ARE IN INCHES; MILLIMETER DIMENSIONS
 (IN PARENTHESES) ARE ROUNDED-OFF INCH EQUIVALENTS FOR
 REFERENCE ONLY AND ARE NOT APPROPRIATE FOR USE IN DESIGN.
 CORNER LEADS MAY BE CONFIGURED AS WHOLE OR HALF LEADS.

Figure 17. 24-Lead Plastic Dual In-Line Package [PDIP]
 Narrow Body
 (N-24-1)

Dimensions shown in inches and (millimeters)

071006-A

ORDERING GUIDE

| Model ¹ | Temperature Range | Package Description | Package Option |
|--------------------|-------------------|---|----------------|
| AD7306ANZ | -40°C to +85°C | 24-Lead Plastic Dual In-Line Package [PDIP] | N-24-1 |
| AD7306AR | -40°C to +85°C | 24-Lead Standard Small Outline Package [SOIC_W] | RW-24 |
| AD7306ARZ | -40°C to +85°C | 24-Lead Standard Small Outline Package [SOIC_W] | RW-24 |
| AD7306JNZ | 0°C to 70°C | 24-Lead Plastic Dual In-Line Package [PDIP] | N-24-1 |
| AD7306JRZ | 0°C to 70°C | 24-Lead Standard Small Outline Package [SOIC_W] | RW-24 |
| AD7306JRZ-REEL | 0°C to 70°C | 24-Lead Standard Small Outline Package [SOIC_W] | RW-24 |

¹ Z = RoHS Compliant Part.

REVISION HISTORY

8/2018—Rev. C to Rev. D

Changes to Ordering Guide 9

4/2017—Rev. B to Rev. C

Changes to Pin Function Description Table 4

Updated Outline Dimensions 9

Moved Ordering Guide 9

Changes to Ordering Guide 9

Mouser Electronics

Authorized Distributor

Click to View Pricing, Inventory, Delivery & Lifecycle Information:

[Analog Devices Inc.:](#)

[AD7306JNZ](#) [AD7306ANZ](#) [AD7306JRZ](#) [AD7306JRZ-REEL](#) [AD7306ARZ](#)