

# High Temperature 200°C, COG Dielectric, 10 – 200 VDC (Industrial Grade)

## Overview

KEMET's High Temperature surface mount COG Multilayer Ceramic Capacitors (MLCCs) are constructed of a robust and proprietary COG/NP0 base metal electrode (BME) dielectric system that offers industry-leading performance at extreme temperatures up to 200°C. These devices are specifically designed to withstand the demands of harsh industrial environments such as down-hole oil exploration and automotive/avionics engine compartment circuitry.

KEMET's High Temperature COG capacitors are temperature compensating and are well suited for resonant circuit applications or those where Q and stability of capacitance characteristics are required. They exhibit no change in capacitance with respect to time and voltage and boast a negligible change in capacitance with reference to ambient temperature. Capacitance change is limited to  $\pm 30\text{ppm}/^\circ\text{C}$  from  $-55^\circ\text{C}$  to  $+200^\circ\text{C}$ . In addition, these capacitors exhibit high insulation resistance with low dissipation factor at

elevated temperatures up to 200°C. They also exhibit low ESR at high frequencies and offer greater volumetric efficiency over competitive high temperature precious metal electrode (PME) and BME ceramic capacitor devices.

These devices are Lead (Pb)-Free, RoHS and REACH compliant without the need of any exemptions.



## Ordering Information

C	1210	H	124	J	5	G	A	C	TU
Ceramic	Case Size (L" x W")	Specification/ Series	Capacitance Code (pF)	Capacitance Tolerance <sup>1</sup>	Voltage	Dielectric	Failure Rate/ Design	Termination Finish <sup>2</sup>	Packaging/ Grade (C-Spec)
	0402 0603 0805 1206 1210 1812 2220	H = High temperature (200°C)	Two significant digits + number of zeros. Use 9 for 1.0 – 9.9 pF Use 8 for 0.5 – 0.99 pF e.g., 2.2 pF = 229 e.g., 0.5 pF = 508	B = $\pm 0.10$ pF C = $\pm 0.25$ pF D = $\pm 0.5$ pF F = $\pm 1\%$ G = $\pm 2\%$ J = $\pm 5\%$ K = $\pm 10\%$ M = $\pm 20\%$	8 = 10 V 4 = 16 V 3 = 25 V 5 = 50 V 1 = 100 V 2 = 200 V	G = COG	A = N/A	C = 100% Matte Sn L = SnPb (5% Pb minimum) E = Gold (Au) 1.97 – 11.8 $\mu\text{in}$ F = Gold (Au) 30 – 70 $\mu\text{in}$ G = Gold (Au) 100 $\mu\text{in}$ minimum	See "Packaging C-Spec Ordering Options Table" below

<sup>1</sup> Additional capacitance tolerance offerings may be available. Contact KEMET for details.

<sup>2</sup> Additional termination finish options may be available. Contact KEMET for details.

## Benefits

- -55°C to +200°C operating temperature range
- Lead (Pb)-free, RoHS and REACH compliant
- EIA 0402, 0603, 0805, 1206, 1210, 1812, and 2220 case sizes
- DC voltage ratings of 10 V, 16 V, 25 V, 50 V, 100 V, and 200 V
- Capacitance offerings ranging from 0.5 pF up to 470 nF
- Available capacitance tolerances of  $\pm 0.10$  pF,  $\pm 0.25$  pF,  $\pm 0.5$  pF,  $\pm 1\%$ ,  $\pm 2\%$ ,  $\pm 5\%$ ,  $\pm 10\%$  or  $\pm 20\%$
- No piezoelectric noise
- Extremely low ESR and ESL
- High thermal stability
- High ripple current capability
- Preferred capacitance solution at line frequencies and into the MHz range
- No capacitance change with respect to applied rated DC voltage
- Negligible capacitance change with respect to temperature from -55°C to +200°C
- No capacitance decay with time
- Non-polar device, minimizing installation concerns
- 100% pure matte tin-plated termination finish allowing for excellent solderability
- Gold (Au), Tin/Lead (Sn/Pb) and 100% pure matte Tin (Sn) termination finishes available

## Applications

Typical applications include critical timing, tuning, circuits requiring low loss, circuits with pulse, high current, decoupling, bypass, filtering, transient voltage suppression, blocking and energy storage for use in extreme environments such as down-hole exploration, aerospace engine compartments and geophysical probes.

## Packaging C-Spec Ordering Options Table

Termination Finish Options	Packaging Type/Options	Packaging Ordering Code (C-Spec)
<b>Standard Packaging – Unmarked<sup>3</sup></b>		
C = 100% Matte Sn L = SnPb (5% Pb min.) F = Gold (Au) 30 – 70 µin G = Gold (Au) 100 µin minimum	Bulk Bag	Blank <sup>1</sup>
	Waffle Tray <sup>2</sup>	7292
	7" Tape & Reel	TU
	13" Reel	7411 (EIA 0603 and smaller case sizes) 7210 (EIA 0805 and larger case sizes)
	7" Tape & Reel/2 mm pitch <sup>4</sup>	7081
	7" Tape & Reel – 50 pieces	T050
	7" Tape & Reel – 100 pieces	T100
	7" Tape & Reel – 250 pieces	T250
	7" Tape & Reel – 500 pieces	T500
7" Tape & Reel – 1,000 pieces	T1K0	
<b>Moisture Sensitive Packaging<sup>5</sup> – Unmarked<sup>3</sup></b>		
E = Gold (Au) 1.97 – 11.8 µin F = Gold (Au) 30 – 70 µin G = Gold (Au) 100 µin minimum	Waffle Tray <sup>2</sup>	7282
	7" Tape & Reel	7130
	7" Tape & Reel – 50 pieces	Contact KEMET <sup>6</sup>
	7" Tape & Reel – 100 pieces	
	7" Tape & Reel – 250 pieces	
	7" Tape & Reel – 500 pieces	
	7" Tape & Reel – 1,000 pieces	

<sup>1</sup> Default packaging is "Bulk Bag". An ordering code C-Spec is not required for "Bulk Bag" packaging.

<sup>1</sup> "Bulk Bag" packaging option is not available for Gold (Au) termination finish options and case sizes larger than 2225 (5664 Metric).

<sup>2</sup> "Waffle Tray" packaging option is not available for case sizes larger than 2225 (5664 Metric).

<sup>3</sup> The terms "Marked" and "Unmarked" pertain to laser marking option of components. All packaging options labeled as "Unmarked" will contain capacitors that have not been laser marked. The option to laser mark is not available on these devices.

<sup>3</sup> Reeling quantities are dependent upon chip size and thickness dimension. When ordering using the "T1K0" packaging option, 1812 through 2225 case size devices with chip thickness of  $\geq 1.9$  mm (nominal) may be shipped on multiple 7" reels or a single 13" reel. Additional reeling or packaging options may be available. Contact KEMET for details.

<sup>4</sup> The 2 mm pitch option allows for double the packaging quantity of capacitors on a given reel size. This option is limited to EIA 0603 (1608 metric) case size devices. For more information regarding 2 mm pitch option see "Tape & Reel Packaging Information".

<sup>5</sup> Moisture sensitive packaging is required for Gold (Au) termination option "E" (1.97 – 11.8 µin)

<sup>6</sup> Additional reeling or packaging options may be available. Contact KEMET for details.

## Dimensions – Millimeters (Inches)



EIA Size Code	Metric Size Code	L Length	W Width	T Thickness	B Bandwidth	S Separation Minimum	Mounting Technique
0402	1005	1.00 (0.040) ±0.05 (0.002)	0.50 (0.020) ±0.05 (0.002)	See Table 2 for Thickness	0.30 (0.012) ±0.10 (0.004)	0.30 (0.012)	Solder Reflow Only
0603	1608	1.60 (0.063) ±0.15 (0.006)	0.80 (0.032) ±0.15 (0.006)		0.35 (0.014) ±0.15 (0.006)	0.70 (0.028)	Solder Wave or Solder Reflow
0805	2012	2.00 (0.079) ±0.20 (0.008)	1.25 (0.049) ±0.20 (0.008)		0.50 (0.02) ±0.25 (0.010)	0.75 (0.030)	
1206	3216	3.20 (0.126) ±0.20 (0.008)	1.60 (0.063) ±0.20 (0.008)		0.50 (0.02) ±0.25 (0.010)	N/A	Solder Reflow Only
1210	3225	3.20 (0.126) ±0.20 (0.008)	2.50 (0.098) ±0.20 (0.008)		0.50 (0.02) ±0.25 (0.010)		
1812	4532	4.50 (0.177) ±0.30 (0.012)	3.20 (0.126) ±0.30 (0.012)		0.60 (0.024) ±0.35 (0.014)		
2220	5650	5.70 (0.224) ±0.40 (0.016)	5.00 (0.197) ±0.40 (0.016)		0.60 (0.024) ±0.35 (0.014)		

## Qualification/Certification

High temperature (200°C) Industrial grade products meet or exceed the requirements outlined in Table 4, Performance & Reliability. Qualification packages are available for review and download on our website at [www.kemet.com/hightemp](http://www.kemet.com/hightemp)

## Environmental Compliance

Lead (Pb)-free, RoHS, and REACH compliant without exemptions (excluding SnPb termination finish option).

## Electrical Parameters/Characteristics

Item	Parameters/Characteristics
Operating Temperature Range	-55°C to +200°C
Capacitance Change with Reference to +25°C and 0 VDC Applied (TCC)	±30 ppm/°C (up to 200°C)
Aging Rate (Maximum % Capacitance Loss/Decade Hour)	0%
<sup>1</sup> Dielectric Withstanding Voltage (DWV)	250% of rated voltage (5±1 seconds and charge/discharge not exceeding 50 mA)
<sup>2</sup> Dissipation Factor (DF) Maximum Limit at 25°C	0.1%
<sup>3</sup> Insulation Resistance (IR) Minimum Limit at 25°C	1,000 megohm microfarads or 100 GΩ (Rated voltage applied for 120±5 seconds at 25°C)

<sup>1</sup> DWV is the voltage a capacitor can withstand (survive) for a short period of time. It exceeds the nominal and continuous working voltage of the capacitor.

<sup>2</sup> Capacitance and dissipation factor (DF) measured under the following conditions:

1 MHz ±100 kHz and 1.0 ±0.2 Vrms if capacitance ≤ 1,000 pF

1 kHz ±50 Hz and 1.0 ±0.2 Vrms if capacitance > 1,000 pF

<sup>3</sup> To obtain IR limit, divide MQ-μF value by the capacitance and compare to GΩ limit. Select the lower of the two limits.

Note: When measuring capacitance it is important to ensure the set voltage level is held constant. The HP4284 & Agilent E4980 have a feature known as Automatic Level Control (ALC). The ALC feature should be switched to "ON."

## Post Environmental Limits

High Temperature Life, Biased Humidity, Moisture Resistance					
Dielectric	Rated DC Voltage	Capacitance Value	Dissipation Factor (Maximum %)	Capacitance Shift	Insulation Resistance
COG	All	All	0.5	0.3% or ±0.25 pF	10% of Initial Limit

## Electrical Characteristics

Delta Cap vs. Temperature (Typical)

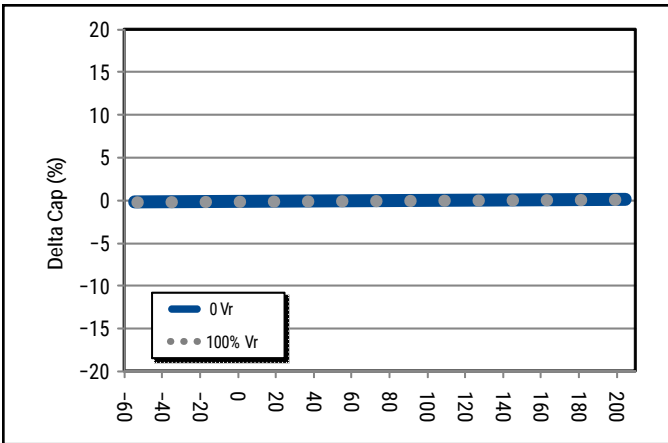

C1210H104J1GAC - Life Test IR Distribution (Lognormal)

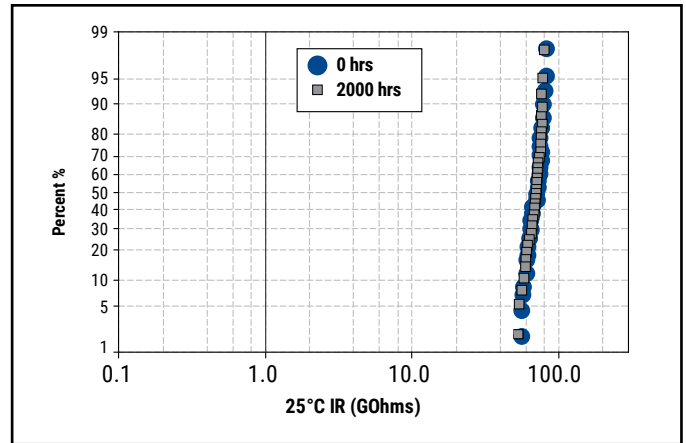

Capacitance vs. Temperature with 25 V DC Bias (Rated Voltage)

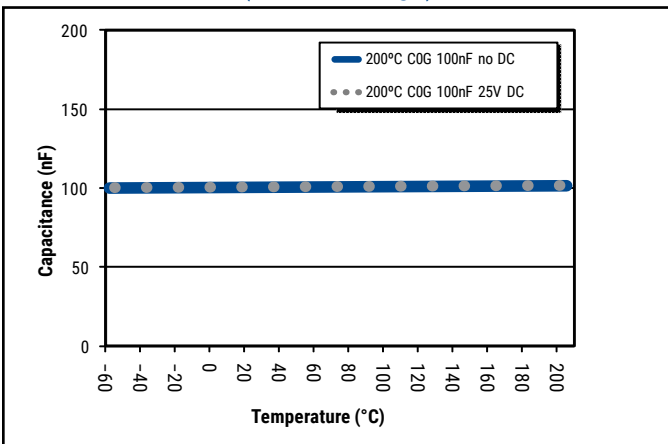

DF vs. Temperature without DC Bias.

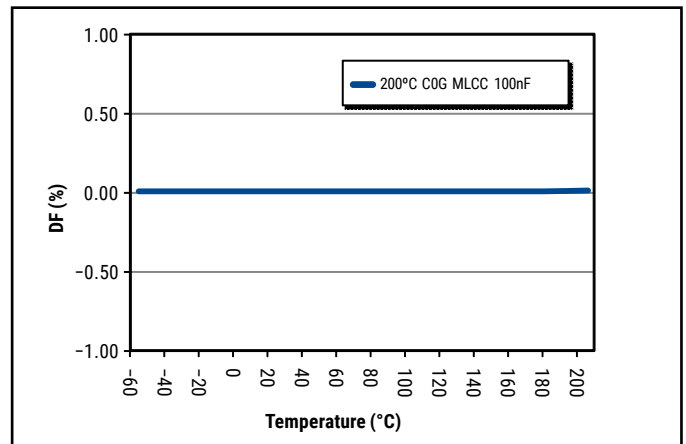

IR vs. Temperature with 25 V DC Bias (Rated Voltage)

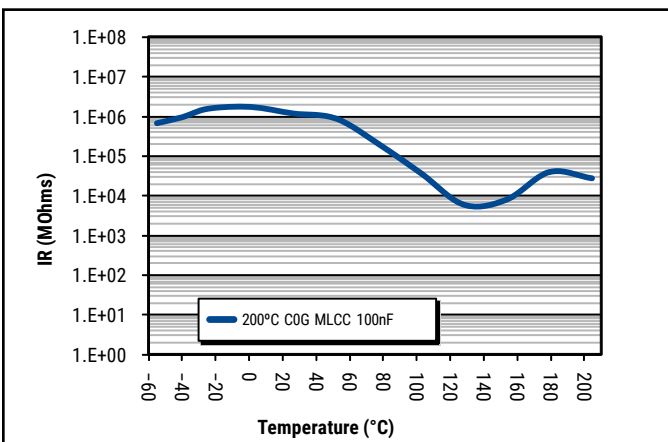

BME vs. PME/IR vs. Temperature with 25 V DC Bias (Rated Voltage)

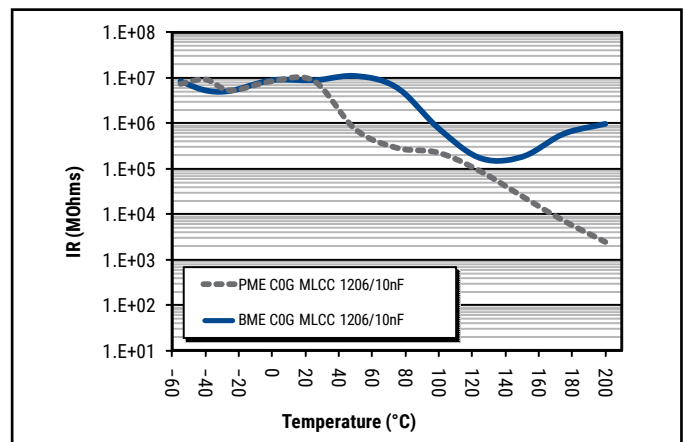

**Table 1A – Capacitance Range/Selection Waterfall (0402 – 1206 Case Sizes)**

Capacitance	Cap Code	Case Size / Series			C0402H					C0603H						C0805H						C1206H										
		Voltage Code			8	4	3	5	1	8	4	3	5	1	2	8	4	3	5	1	2	8	4	3	5	1	2					
		Rated Voltage (VDC)			10	16	25	50	100	10	16	25	50	100	200	10	16	25	50	100	200	10	16	25	50	100	200					
		Capacitance Tolerance			Product Availability and Chip Thickness Codes See Table 2 for Chip Thickness Dimensions																											
0.5 & 0.75 pF	508 & 758	B	C	D						BB	BB	BB	BB		CF	CF	CF	CF	CF	CF	DN	DN	DN	DN	DN	DN						
1.0 - 9.0 pF*	109 - 919*	B	C	D						BB	BB	BB	BB		CF	CF	CF	CF	CF	CF	DN	DN	DN	DN	DN	DN	EB	EB	EB	EB	EB	EB
10 - 91 pF*	100 - 910*				F	G	J	K	M	BB	BB	BB	BB		CF	CF	CF	CF	CF	CF	DN	DN	DN	DN	DN	DN	EB	EB	EB	EB	EB	EB
100 - 180 pF*	101 - 181*				F	G	J	K	M	BB	BB	BB	BB	BB	CF	CF	CF	CF	CF	CF	DN	DN	DN	DN	DN	DN	EB	EB	EB	EB	EB	EB
200 - 430 pF*	201 - 431*				F	G	J	K	M	BB	BB	BB	BB	BB	CF	CF	CF	CF	CF	CF	DN	DN	DN	DN	DN	DN	EB	EB	EB	EB	EB	EB
470 pF	471				F	G	J	K	M	BB	BB	BB	BB	BB	CF	CF	CF	CF	CF	CF	DN	DN	DN	DN	DN	DN	EB	EB	EB	EB	EB	EB
510 pF	511				F	G	J	K	M	BB	BB	BB	BB	BB	CF	CF	CF	CF	CF	CF	DN	DN	DN	DN	DN	DN	EB	EB	EB	EB	EB	EB
560 pF	561				F	G	J	K	M	BB	BB	BB	BB	BB	CF	CF	CF	CF	CF	CF	DN	DN	DN	DN	DN	DN	EB	EB	EB	EB	EB	EB
620 pF	621				F	G	J	K	M	BB	BB	BB	BB	BB	CF	CF	CF	CF	CF	CF	DN	DN	DN	DN	DN	DN	EB	EB	EB	EB	EB	EB
680 pF	681				F	G	J	K	M	BB	BB	BB	BB	BB	CF	CF	CF	CF	CF	CF	DN	DN	DN	DN	DN	DN	EB	EB	EB	EB	EB	EB
750 pF	751				F	G	J	K	M	BB	BB	BB	BB	BB	CF	CF	CF	CF	CF	CF	DN	DN	DN	DN	DN	DN	EB	EB	EB	EB	EB	EB
820 pF	821				F	G	J	K	M	BB	BB	BB	BB	BB	CF	CF	CF	CF	CF	CF	DN	DN	DN	DN	DN	DN	EB	EB	EB	EB	EB	EB
910 pF	911				F	G	J	K	M	BB	BB	BB	BB	BB	CF	CF	CF	CF	CF	CF	DN	DN	DN	DN	DP	DP	EB	EB	EB	EB	EB	EB
1,000 pF	102				F	G	J	K	M	BB	BB	BB	BB	BB	CF	CF	CF	CF	CF	CF	DN	DN	DN	DN	DP	DP	EB	EB	EB	EB	EB	EE
1,100 pF	112				F	G	J	K	M	BB	BB	BB	BB	BB	CF	CF	CF	CF	CF	CF	DN	DN	DN	DN	DN	DN	EB	EB	EB	EB	EB	EB
1,200 pF	122				F	G	J	K	M	BB	BB	BB	BB	BB	CF	CF	CF	CF	CF	CF	DN	DN	DN	DN	DN	DN	EB	EB	EB	EB	EB	EB
1,300 pF	132				F	G	J	K	M	BB	BB	BB	BB	BB	CF	CF	CF	CF	CF	CF	DP	DP	DP	DP	DP	DP	EB	EB	EB	EB	EC	EC
1,500 pF	152				F	G	J	K	M	BB	BB	BB	BB	BB	CF	CF	CF	CF	CF	CF	DP	DP	DP	DP	DP	DP	EB	EB	EB	EB	ED	ED
1,600 pF	162				F	G	J	K	M						CF	CF	CF	CF	CF	CF	DP	DP	DP	DP	DP	DP	EB	EB	EB	EB	ED	ED
1,800 pF	182				F	G	J	K	M						CF	CF	CF	CF	CF	CF	DP	DP	DP	DP	DP	DP	EB	EB	EB	EB	ED	ED
2,000 pF	202				F	G	J	K	M						CF	CF	CF	CF	CF	CF	DN	DN	DN	DN	DN	DN	EB	EB	EB	EB	ED	ED
2,200 pF	222				F	G	J	K	M						CF	CF	CF	CF	CF	CF	DN	DN	DN	DN	DN	DN	EB	EB	EB	EB	EE	EE
2,400 pF	242				F	G	J	K	M						CF	CF	CF	CF	CF	CF	DN	DN	DN	DN	DN	DN	EB	EB	EB	EB	EC	EC
2,700 pF	272				F	G	J	K	M						CF	CF	CF	CF	CF	CF	DN	DN	DN	DN	DN	DN	EB	EB	EB	EB	EC	EC
3,000 pF	302				F	G	J	K	M						CF	CF	CF	CF	CF	CF	DP	DP	DP	DP	DN	DN	EC	EC	EC	EC	EC	EC
3,300 pF	332				F	G	J	K	M						CF	CF	CF	CF	CF	CF	DP	DP	DP	DP	DN	DN	EC	EC	EC	EC	EE	EE
3,600 pF	362				F	G	J	K	M						CF	CF	CF	CF	CF	CF	DP	DP	DP	DP	DN	DN	EC	EC	EC	EC	EE	EE
3,900 pF	392				F	G	J	K	M						CF	CF	CF	CF	CF	CF	DE	DE	DE	DE	DN	DN	EC	EC	EC	EC	EF	EF
4,300 pF	432				F	G	J	K	M						CF	CF	CF	CF	CF	CF	DE	DE	DE	DE	DN	DN	EC	EC	EC	EC	EC	EC
4,700 pF	472				F	G	J	K	M						CF	CF	CF	CF	CF	CF	DE	DE	DE	DE	DN	DN	EC	EC	EC	EC	EC	EC
5,100 pF	512				F	G	J	K	M						CF	CF	CF	CF	CF	CF	DE	DE	DE	DE	DN	DN	ED	ED	ED	ED	ED	ED
5,600 pF	562				F	G	J	K	M						CF	CF	CF	CF	CF	CF	DN	DN	DN	DN	DN	DN	ED	ED	ED	ED	ED	ED
6,200 pF	622				F	G	J	K	M						CF	CF	CF	CF	CF	CF	DN	DN	DN	DN	DN	DN	EB	EB	EB	EB	EB	EB
6,800 pF	682				F	G	J	K	M						CF	CF	CF	CF	CF	CF	DN	DN	DN	DN	DN	DN	EB	EB	EB	EB	EB	EB
7,500 pF	752				F	G	J	K	M						CF	CF	CF	CF	CF	CF	DN	DN	DN	DN	DN	DN	EB	EB	EB	EB	EB	EB
8,200 pF	822				F	G	J	K	M						CF	CF	CF	CF	CF	CF	DN	DN	DN	DN	DN	DN	EC	EC	EC	EC	EB	EB
9,100 pF	912				F	G	J	K	M						CF	CF	CF	CF	CF	CF	DN	DN	DN	DN	DN	DN	EC	EC	EC	EC	EB	EB
10,000 pF	103				F	G	J	K	M						CF	CF	CF	CF	CF	CF	DN	DN	DN	DN	DP	DP	ED	ED	ED	ED	EB	EB
12,000 pF	123				F	G	J	K	M												DN	DN	DN	DN	DN	DE	EB	EB	EB	EB	EB	EB
15,000 pF	153				F	G	J	K	M												DN	DN	DN	DN	DP	DG	EB	EB	EB	EB	EB	EB
18,000 pF	183				F	G	J	K	M												DN	DN	DN	DP	DF	DF	EB	EB	EB	EB	EB	EB
22,000 pF	223				F	G	J	K	M												DP	DP	DP	DF	DF	DF	EB	EB	EB	EB	EC	EC
27,000 pF	273				F	G	J	K	M												DF	DF	DF	DF	DF	DF	EB	EB	EB	EB	EE	EE
33,000 pF	333				F	G	J	K	M												DG	DG	DG	DG	DG	DG	EB	EB	EB	EB	EE	EE
39,000 pF	393				F	G	J	K	M												DG	DG	DG	DG	DG	DG	EC	EC	EC	EE	EH	EH
47,000 pF	473				F	G	J	K	M												DG	DG	DG	DG	DG	DG	EC	EC	EC	EE	EH	EH
56,000 pF	563				F	G	J	K	M																		ED	ED	ED	EF	EH	EH
68,000 pF	683				F	G	J	K	M																		EF	EF	EF	EH	EH	EH
82,000 pF	823				F	G	J	K	M																		EH	EH	EH	EH	EH	EH
0.10 μF	104				F	G	J	K	M																		EH	EH	EH	EH	EH	EH

\*Capacitance range Includes E24 decade values only. (i.e., 10, 11, 12, 13, 15, 16, 18, 20, 22, 24, 27, 30, 33, 36, 39, 43, 47, 51, 56, 62, 68, 75, 82, and 91)  
 KEMET reserves the right to substitute product with an improved temperature characteristic, tighter capacitance tolerance and/or higher voltage capability within the same form factor (configuration and dimensions).

These products are protected under US Patents 7,172,985 and 7,670,981, other patents pending, and any foreign counterparts.





**Table 2A – Chip Thickness/Tape & Reel Packaging Quantities**

Thickness Code	Case Size <sup>1</sup>	Thickness ± Range (mm)	Paper Quantity <sup>1</sup>		Plastic Quantity	
			7" Reel	13" Reel	7" Reel	13" Reel
BB	0402	0.50±0.05	10,000	50,000	0	0
CF	0603	0.80±0.07	4,000	15,000	0	0
DN	0805	0.78±0.10	4,000	15,000	0	0
DP	0805	0.90±0.10	4,000	15,000	0	0
DE	0805	1.00±0.10	0	0	2,500	10,000
DF	0805	1.10±0.10	0	0	2,500	10,000
DG	0805	1.25±0.15	0	0	2,500	10,000
EB	1206	0.78±0.10	4,000	10,000	4,000	10,000
EC	1206	0.90±0.10	0	0	4,000	10,000
ED	1206	1.00±0.10	0	0	2,500	10,000
EE	1206	1.10±0.10	0	0	2,500	10,000
EF	1206	1.20±0.15	0	0	2,500	10,000
EH	1206	1.60±0.20	0	0	2,000	8,000
FB	1210	0.78±0.10	0	0	4,000	10,000
FC	1210	0.90±0.10	0	0	4,000	10,000
FE	1210	1.00±0.10	0	0	2,500	10,000
FF	1210	1.10±0.10	0	0	2,500	10,000
FG	1210	1.25±0.15	0	0	2,500	10,000
FH	1210	1.55±0.15	0	0	2,000	8,000
FM	1210	1.70±0.20	0	0	2,000	8,000
GB	1812	1.00±0.10	0	0	1,000	4,000
GD	1812	1.25±0.15	0	0	1,000	4,000
GH	1812	1.40±0.15	0	0	1,000	4,000
GK	1812	1.60±0.20	0	0	1,000	4,000
GN	1812	1.70±0.20	0	0	1,000	4,000
JJ	2220	2.20±0.15	0	0	500	2,000
Thickness Code	Case Size <sup>1</sup>	Thickness ± Range (mm)	7" Reel	13" Reel	7" Reel	13" Reel
			Paper Quantity <sup>1</sup>		Plastic Quantity	

Package quantity based on finished chip thickness specifications.

<sup>1</sup> If ordering using the 2mm Tape and Reel pitch option, the packaging quantity outlined in the table above will be doubled. This option is limited to EIA 0603 (1608 metric) case size devices. For more information regarding 2mm pitch option see "Tape & Reel Packaging Information".

**Table 2B – Bulk Packaging Quantities**

Packaging Type		Loose Packaging		Secure Packaging		
		Bulk Bag (default)		2" x 2" Waffle Pack/ Tray <sup>3</sup>		
Packaging C-Spec <sup>1</sup>		N/A <sup>2</sup>		7282/7292		
Case Size		Chip Thickness (mm)	Packaging Quantities (pieces/unit packaging)			
EIA (in)	Metric (mm)		Minimum	Maximum	Minimum	Maximum
0402	1005	All	1	50,000	1	368
0603	1608					368
0805	2012					100
1206	3216	≤ 1.25 (nominal)		126		
1206	3216	> 1.25 (nominal)		50		
1210	3225	All		20,000		1
1808	4520		50			
1812	4532		42			
1825	4564		20			
2220	5650		20			
2225	5664		20			

<sup>1</sup> The "Packaging C-Spec" is a 4-digit code which identifies the packaging type. When ordering, the proper code must be included in the 15th through 18th character positions of the ordering code. See "Ordering Information" section of this document for further details. Product ordered without a packaging C-Spec will default to our standard "Bulk Bag" packaging.

<sup>2</sup> A packaging C-Spec (see note 1 above) is not required For "Bulk Bag" packaging (excluding Anti-Static Bulk Bag). The 15th through 18th character positions of the ordering code should be left blank. All product ordered without a packaging C-Spec will default to our standard "Bulk Bag" packaging.

<sup>3</sup> Also commonly referred to as "Chip Carrier" or "Molded Tray". All tray packaging options offer static protection.

**Table 3 – Chip Capacitor Land Pattern Design Recommendations per IPC–7351**

EIA Size Code	Metric Size Code	Density Level A: Maximum (Most) Land Protrusion (mm)					Density Level B: Median (Nominal) Land Protrusion (mm)					Density Level C: Minimum (Least) Land Protrusion (mm)				
		C	Y	X	V1	V2	C	Y	X	V1	V2	C	Y	X	V1	V2
0402	1005	0.50	0.72	0.72	2.20	1.20	0.45	0.62	0.62	1.90	1.00	0.40	0.52	0.52	1.60	0.80
0603	1608	0.90	1.15	1.10	4.00	2.10	0.80	0.95	1.00	3.10	1.50	0.60	0.75	0.90	2.40	1.20
0805	2012	1.00	1.35	1.55	4.40	2.60	0.90	1.15	1.45	3.50	2.00	0.75	0.95	1.35	2.80	1.70
1206	3216	1.60	1.35	1.90	5.60	2.90	1.50	1.15	1.80	4.70	2.30	1.40	0.95	1.70	4.00	2.00
1210	3225	1.60	1.35	2.80	5.65	3.80	1.50	1.15	2.70	4.70	3.20	1.40	0.95	2.60	4.00	2.90
1210 <sup>1</sup>	3225	1.50	1.60	2.90	5.60	3.90	1.40	1.40	2.80	4.70	3.30	1.30	1.20	2.70	4.00	3.00
1812	4532	2.15	1.60	3.60	6.90	4.60	2.05	1.40	3.50	6.00	4.00	1.95	1.20	3.40	5.30	3.70
2220	5650	2.75	1.70	5.50	8.20	6.50	2.65	1.50	5.40	7.30	5.90	2.55	1.30	5.30	6.60	5.60

<sup>1</sup> Only for capacitance values  $\geq 22 \mu F$

**Density Level A:** For low-density product applications. Recommended for wave solder applications and provides a wider process window for reflow solder processes. KEMET only recommends wave soldering of EIA 0603, 0805 and 1206 case sizes.

**Density Level B:** For products with a moderate level of component density. Provides a robust solder attachment condition for reflow solder processes.

**Density Level C:** For high component density product applications. Before adapting the minimum land pattern variations the user should perform qualification testing based on the conditions outlined in IPC Standard 7351 (IPC-7351).

Image below based on Density Level B for an EIA 1210 case size.

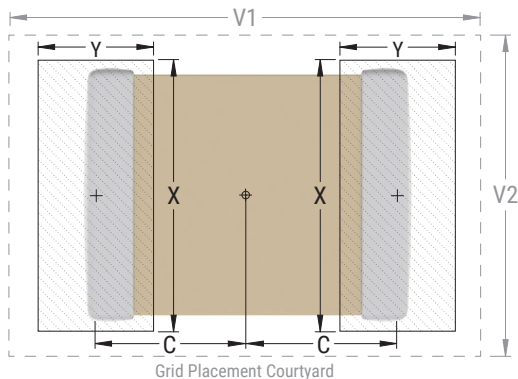

## Soldering Process

### Recommended Soldering Technique:

- Solder wave or solder reflow for EIA case sizes 0603, 0805 and 1206
- All other EIA case sizes are limited to solder reflow only

### Recommended Reflow Soldering Profile:

KEMET’s families of surface mount multilayer ceramic capacitors (SMD MLCCs) are compatible with wave (single or dual), convection, IR or vapor phase reflow techniques. Preheating of these components is recommended to avoid extreme thermal stress. KEMET’s recommended profile conditions for convection and IR reflow reflect the profile conditions of the IPC/J-STD-020 standard for moisture sensitivity testing. These devices can safely withstand a maximum of three reflow passes at these conditions.

Profile Feature	Termination Finish	
	SnPb	100% Matte Sn
<b>Preheat/Soak</b>		
Temperature Minimum ( $T_{Smin}$ )	100°C	150°C
Temperature Maximum ( $T_{Smax}$ )	150°C	200°C
Time ( $t_s$ ) from $T_{Smin}$ to $T_{Smax}$	60 – 120 seconds	60 – 120 seconds
Ramp-Up Rate ( $T_L$ to $T_p$ )	3°C/second maximum	3°C/second maximum
Liquidous Temperature ( $T_L$ )	183°C	217°C
Time Above Liquidous ( $t_L$ )	60 – 150 seconds	60 – 150 seconds
Peak Temperature ( $T_p$ )	235°C	260°C
Time Within 5°C of Maximum Peak Temperature ( $t_p$ )	20 seconds maximum	30 seconds maximum
Ramp-Down Rate ( $T_p$ to $T_L$ )	6°C/second maximum	6°C/second maximum
Time 25°C to Peak Temperature	6 minutes maximum	8 minutes maximum

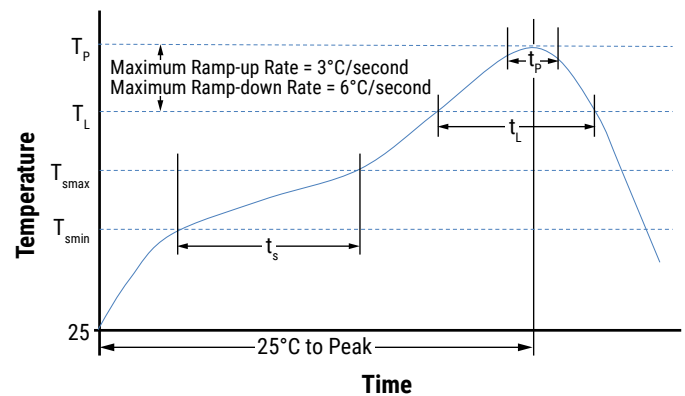

Note 1: All temperatures refer to the center of the package, measured on the capacitor body surface that is facing up during assembly reflow.

**Table 4 – Performance & Reliability: Test Methods and Conditions**

Product Qualification Test Plan	
Reliability/Environmental Tests per MIL-STD-202//JESD22	
High Temperature Life	200°C rated voltage 1,000 hours
Load Humidity	85°C/85%RH rated voltage 1,000 hours
Low Voltage Humidity	85°C/85%RH, 1.5 V, 1,000 hours
Temperature Cycling	-55°C to +200°C, 50 Cycles
Thermal Shock	-55°C to +150°C, 20 seconds transfer, 15 minute dwell, 300 cycles
Moisture Resistance	Cycled Temp/RH 0 V, 10 cycles at 24 hours each
Physical, Mechanical & Process Tests per MIL-STD 202/JIS-C-6429	
Resistance to Solvents	Include Aqueous wash chemical, OKEM Clean or equivalent
Mechanical Shock and Vibration	Method 213: Figure 1, Condition F Method 204: 5 gs for 20 minutes 12 cycles
Resistance to Soldering Heat	Condition B, no per-heat of samples, Single Wave Solder
Terminal Strength	Force of 1.8 kg for 60 seconds
Board Flex	Appendix 2, Note: 3.0 mm (minimum)

## Storage and Handling

Ceramic chip capacitors should be stored in normal working environments. While the chips themselves are quite robust in other environments, solderability will be degraded by exposure to high temperatures, high humidity, corrosive atmospheres, and long term storage. In addition, packaging materials will be degraded by high temperature—reels may soften or warp and tape peel force may increase. KEMET recommends that maximum storage temperature not exceed 40°C and maximum storage humidity not exceed 70% relative humidity. In addition, temperature fluctuations should be minimized to avoid condensation on the parts and atmospheres should be free of chlorine and sulfur bearing compounds. For optimized solderability chip stock should be used promptly, preferably within the time frame outlined in the table below:

Termination Finish	Termination Finish Ordering Code <sup>1</sup>	Storage Life
100% Matte Tin (Sn)	C	1.5 years upon receipt
SnPb (5% Pb min.)	L	1.5 years upon receipt
Gold (Au) 1.97 – 11.8 µin <sup>2</sup>	E	6 months upon receipt <sup>2</sup>
Gold (Au) 30 – 70 µin	F	1.5 years upon receipt
Gold (Au) 100 µin min.	G	1.5 years upon receipt

<sup>1</sup> The fourteenth (14th) character position of the KEMET part number is assigned to identify and/or define the termination finish. For more information, see "Ordering Information" section of this document.

<sup>2</sup> Gold plating option "E" devices should remain in its factory sealed moisture sensitive packaging during storage. If the factory sealed packaging is disturbed please store any remaining packaged components in a dry box container to prevent oxidation of the termination finish.

## Construction

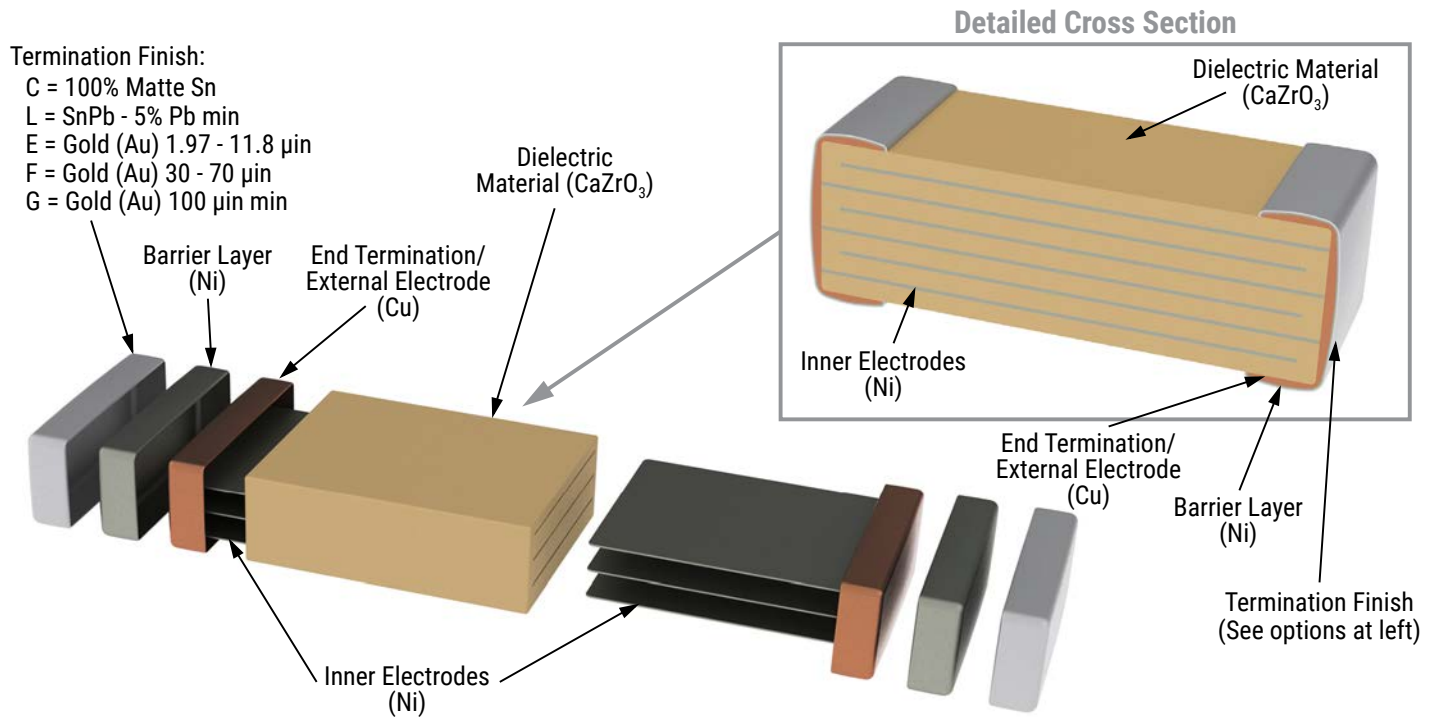

## Capacitor Marking (Optional):

Laser marking option is not available on:

- COG, Ultra Stable X8R and Y5V dielectric devices
- EIA 0402 case size devices
- EIA 0603 case size devices with Flexible Termination option.
- KPS Commercial and Automotive grade stacked devices.

These capacitors are supplied unmarked only.

## Tape & Reel Packaging Information

KEMET offers multilayer ceramic chip capacitors packaged in 8, 12 and 16 mm tape on 7" and 13" reels in accordance with EIA Standard 481. This packaging system is compatible with all tape-fed automatic pick and place systems. See Table 2 for details on reeling quantities for commercial chips.

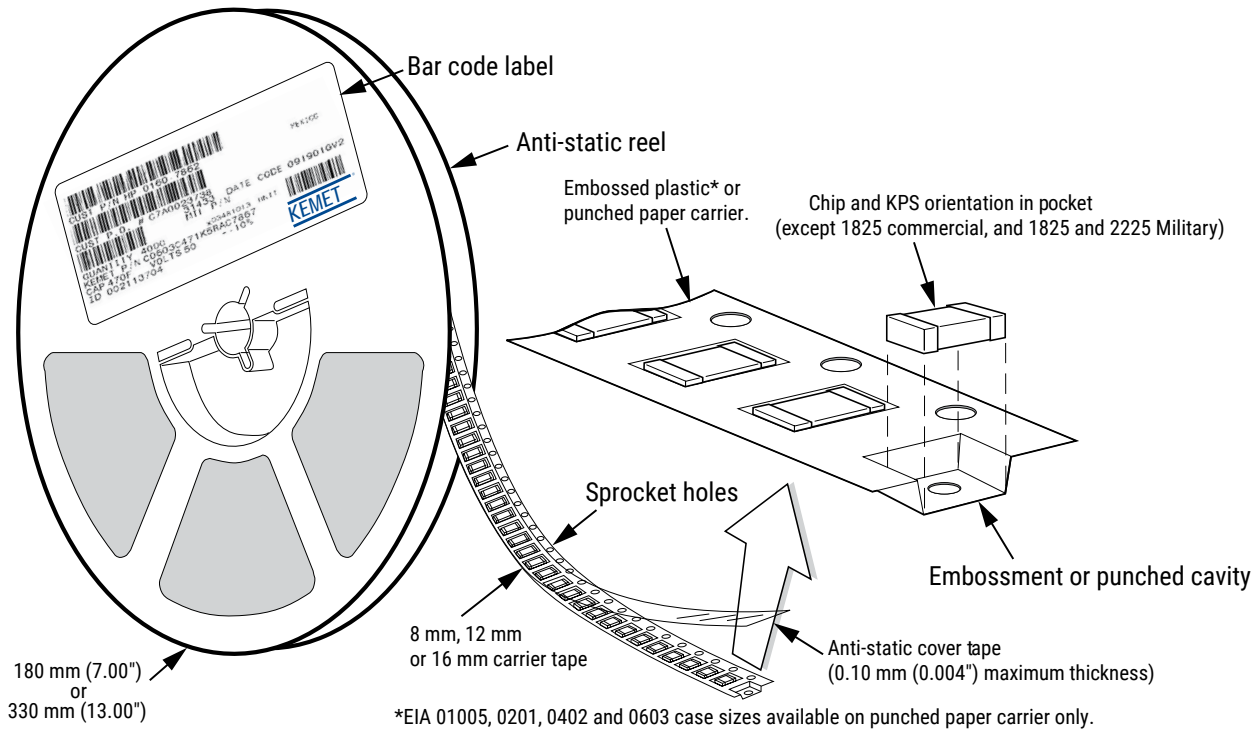

**Table 5 – Carrier Tape Configuration, Embossed Plastic & Punched Paper (mm)**

EIA Case Size	Tape Size (W)*	Embossed Plastic		Punched Paper	
		7" Reel	13" Reel	7" Reel	13" Reel
		Pitch (P <sub>1</sub> )*		Pitch (P <sub>1</sub> )*	
01005 – 0402	8			2	2
0603	8			2/4	2/4
0805	8	4	4	4	4
1206 – 1210	8	4	4	4	4
1805 – 1808	12	4	4		
≥ 1812	12	8	8		
KPS 1210	12	8	8		
KPS 1812 & 2220	16	12	12		
Array 0508 & 0612	8	4	4		

### New 2 mm Pitch Reel Options\*

Packaging Ordering Code (C-Spec)	Packaging Type/Options
C-3190	Automotive grade 7" reel unmarked
C-3191	Automotive grade 13" reel unmarked
C-7081	Commercial grade 7" reel unmarked
C-7082	Commercial grade 13" reel unmarked

\* 2 mm pitch reel only available for 0603 EIA case size.  
 2 mm pitch reel for 0805 EIA case size under development.

### Benefits of Changing from 4 mm to 2 mm Pitching Spacing

- Lower placement costs
- Double the parts on each reel results in fewer reel changes and increased efficiency
- Fewer reels result in lower packaging, shipping and storage costs, reducing waste

\*Refer to Figures 1 & 2 for W and P<sub>1</sub> carrier tape reference locations.

\*Refer to Tables 6 & 7 for tolerance specifications.

**Figure 1 – Embossed (Plastic) Carrier Tape Dimensions**

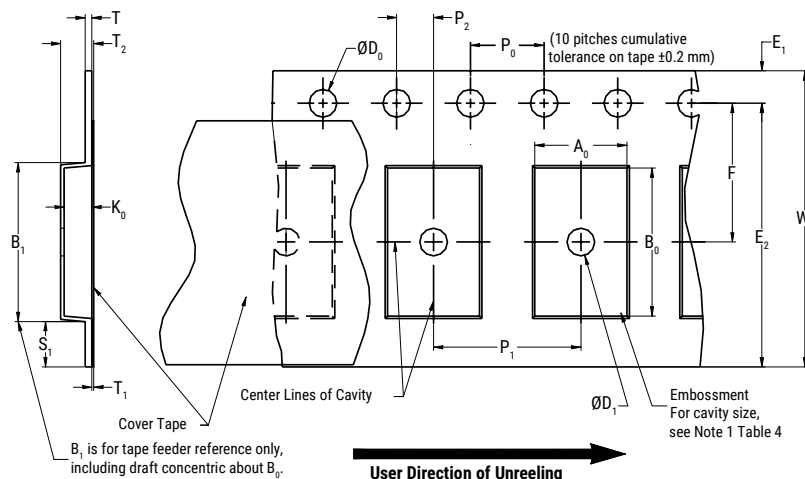

**Table 6 – Embossed (Plastic) Carrier Tape Dimensions**

Metric will govern

Constant Dimensions – Millimeters (Inches)									
Tape Size	D <sub>0</sub>	D <sub>1</sub> Minimum Note 1	E <sub>1</sub>	P <sub>0</sub>	P <sub>2</sub>	R Reference Note 2	S <sub>1</sub> Minimum Note 3	T Maximum	T <sub>1</sub> Maximum
8 mm	1.5+0.10 -0.0 (0.059+0.004 -0.0)	1.0 (0.039)	1.75±0.10 (0.069±0.004)	4.0±0.10 (0.157±0.004)	2.0±0.05 (0.079±0.002)	25.0 (0.984)	0.600 (0.024)	0.600 (0.024)	0.100 (0.004)
12 mm		1.5 (0.059)							
16 mm		30 (1.181)							
Variable Dimensions – Millimeters (Inches)									
Tape Size	Pitch	B <sub>1</sub> Maximum Note 4	E <sub>2</sub> Minimum	F	P <sub>1</sub>	T <sub>2</sub> Maximum	W Maximum	A <sub>0</sub> , B <sub>0</sub> & K <sub>0</sub>	
8 mm	Single (4 mm)	4.35 (0.171)	6.25 (0.246)	3.5±0.05 (0.138±0.002)	4.0±0.10 (0.157±0.004)	2.5 (0.098)	8.3 (0.327)	Note 5	
12 mm	Single (4 mm) & Double (8 mm)	8.2 (0.323)	10.25 (0.404)	5.5±0.05 (0.217±0.002)	8.0±0.10 (0.315±0.004)	4.6 (0.181)	12.3 (0.484)		
16 mm	Triple (12 mm)	12.1 (0.476)	14.25 (0.561)	7.5±0.05 (0.138±0.002)	12.0±0.10 (0.157±0.004)	4.6 (0.181)	16.3 (0.642)		

- The embossment hole location shall be measured from the sprocket hole controlling the location of the embossment. Dimensions of embossment location and hole location shall be applied independent of each other.
- The tape with or without components shall pass around R without damage (see Figure 6).
- If S<sub>1</sub> < 1.0 mm, there may not be enough area for cover tape to be properly applied (see EIA Standard 481 paragraph 4.3 section b).
- B<sub>1</sub> dimension is a reference dimension for tape feeder clearance only.
- The cavity defined by A<sub>0</sub>, B<sub>0</sub> and K<sub>0</sub> shall surround the component with sufficient clearance that:
  - the component does not protrude above the top surface of the carrier tape.
  - the component can be removed from the cavity in a vertical direction without mechanical restriction, after the top cover tape has been removed.
  - rotation of the component is limited to 20° maximum for 8 and 12 mm tapes and 10° maximum for 16 mm tapes (see Figure 3).
  - lateral movement of the component is restricted to 0.5 mm maximum for 8 and 12 mm wide tape and to 1.0 mm maximum for 16 mm tape (See Figure 4).
  - for KPS Series product, A<sub>0</sub> and B<sub>0</sub> are measured on a plane 0.3 mm above the bottom of the pocket.
  - see Addendum in EIA Standard 481 for standards relating to more precise taping requirements.



**Figure 2 – Punched (Paper) Carrier Tape Dimensions**

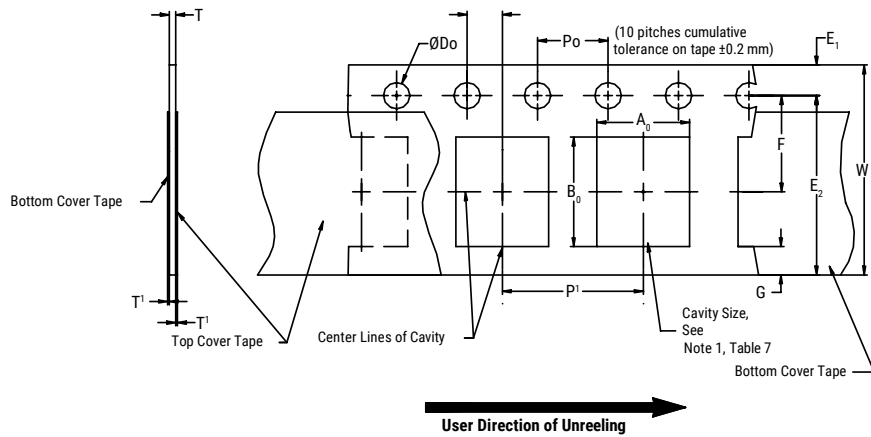

**Table 7 – Punched (Paper) Carrier Tape Dimensions**

Metric will govern

Constant Dimensions – Millimeters (Inches)							
Tape Size	$D_0$	$E_1$	$P_0$	$P_2$	$T_1$ Maximum	G Minimum	R Reference Note 2
8 mm	$1.5 +0.10 -0.0$ (0.059 +0.004 -0.0)	$1.75 \pm 0.10$ (0.069 ±0.004)	$4.0 \pm 0.10$ (0.157 ±0.004)	$2.0 \pm 0.05$ (0.079 ±0.002)	0.10 (0.004) Maximum	0.75 (0.030)	25 (0.984)
Variable Dimensions – Millimeters (Inches)							
Tape Size	Pitch	E2 Minimum	F	$P_1$	T Maximum	W Maximum	$A_0 B_0$
8 mm	Half (2 mm)	6.25 (0.246)	$3.5 \pm 0.05$ (0.138 ±0.002)	$2.0 \pm 0.05$ (0.079 ±0.002)	1.1 (0.098)	8.3 (0.327)	Note 1
8 mm	Single (4 mm)			$4.0 \pm 0.10$ (0.157 ±0.004)			

- The cavity defined by  $A_0$ ,  $B_0$  and  $T$  shall surround the component with sufficient clearance that:
  - the component does not protrude beyond either surface of the carrier tape.
  - the component can be removed from the cavity in a vertical direction without mechanical restriction, after the top cover tape has been removed.
  - rotation of the component is limited to 20° maximum (see Figure 3).
  - lateral movement of the component is restricted to 0.5 mm maximum (see Figure 4).
  - see Addendum in EIA Standard 481 for standards relating to more precise taping requirements.
- The tape with or without components shall pass around R without damage (see Figure 6).

## Packaging Information Performance Notes

- Cover Tape Break Force:** 1.0 Kg minimum.
- Cover Tape Peel Strength:** The total peel strength of the cover tape from the carrier tape shall be:

Tape Width	Peel Strength
8 mm	0.1 to 1.0 Newton (10 to 100 gf)
12 and 16 mm	0.1 to 1.3 Newton (10 to 130 gf)

The direction of the pull shall be opposite the direction of the carrier tape travel. The pull angle of the carrier tape shall be 165° to 180° from the plane of the carrier tape. During peeling, the carrier and/or cover tape shall be pulled at a velocity of 300 ±10 mm/minute.

- Labeling:** Bar code labeling (standard or custom) shall be on the side of the reel opposite the sprocket holes. Refer to EIA Standards 556 and 624.

### Figure 3 – Maximum Component Rotation

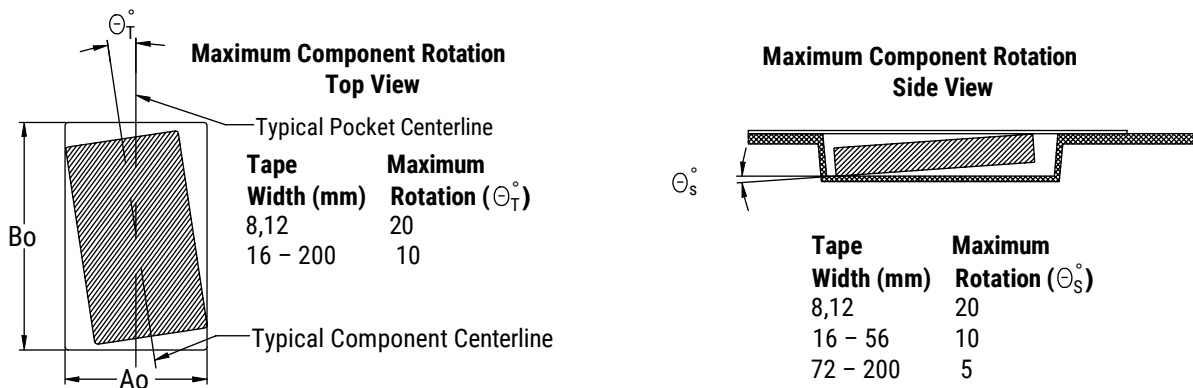

### Figure 4 – Maximum Lateral Movement



### Figure 5 – Bending Radius



**Figure 6 – Reel Dimensions**



Note: Drive spokes optional; if used, dimensions B and D shall apply.

**Table 8 – Reel Dimensions**

Metric will govern

Constant Dimensions – Millimeters (Inches)				
Tape Size	A	B Minimum	C	D Minimum
8 mm	178 ±0.20 (7.008 ±0.008) or 330 ±0.20 (13.000 ±0.008)	1.5 (0.059)	13.0 +0.5/-0.2 (0.521 +0.02/-0.008)	20.2 (0.795)
12 mm				
16 mm				
Variable Dimensions – Millimeters (Inches)				
Tape Size	N Minimum	W <sub>1</sub>	W <sub>2</sub> Maximum	W <sub>3</sub>
8 mm	50 (1.969)	8.4 +1.5/-0.0 (0.331 +0.059/-0.0)	14.4 (0.567)	Shall accommodate tape width without interference
12 mm		12.4 +2.0/-0.0 (0.488 +0.078/-0.0)	18.4 (0.724)	
16 mm		16.4 +2.0/-0.0 (0.646 +0.078/-0.0)	22.4 (0.882)	

**Figure 7 – Tape Leader & Trailer Dimensions**

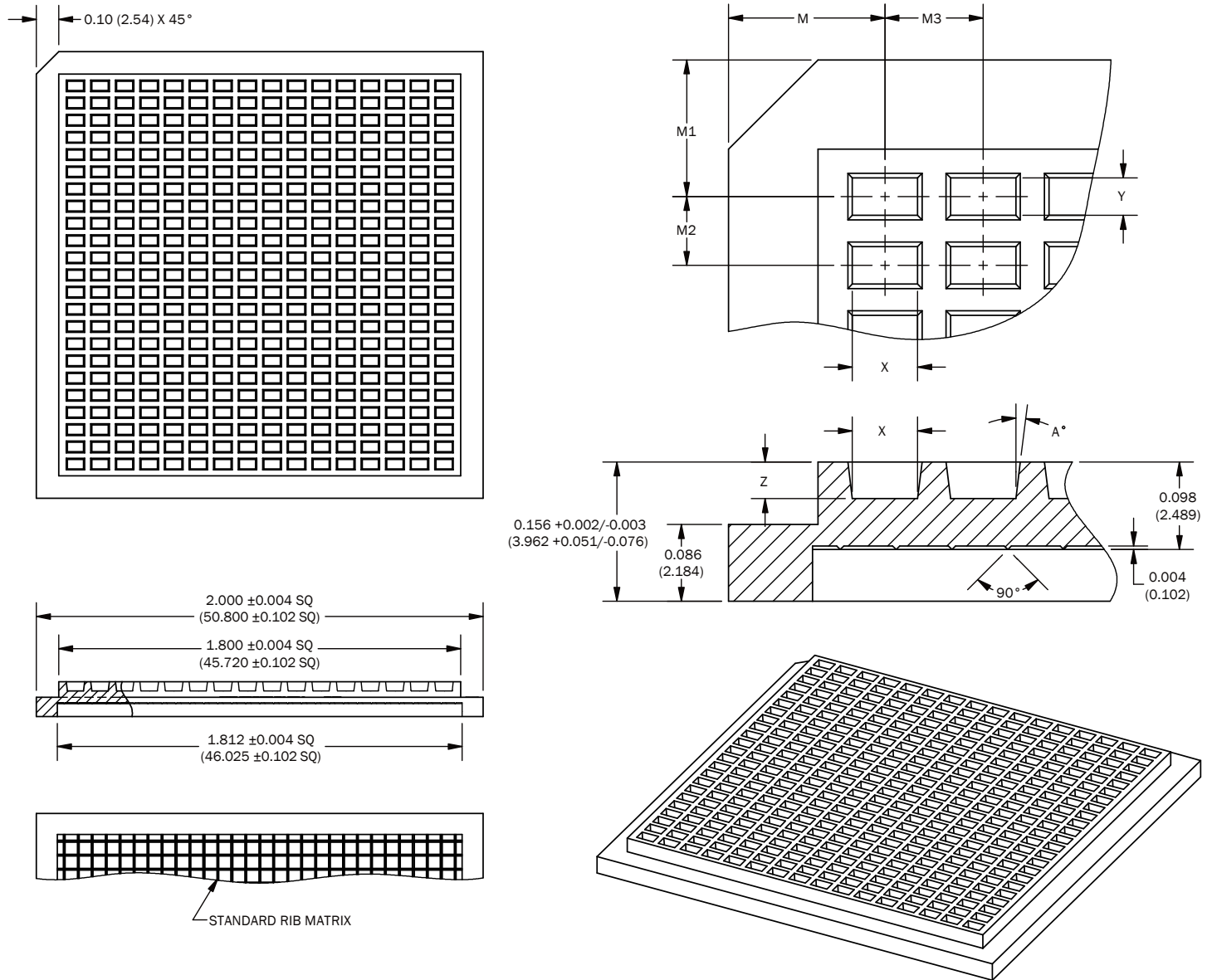

**Figure 8 – Maximum Camber**



## Waffle Tray Packaging Information – 2" x 2" w/ Static Protection

Figure 9 – Waffle Tray Dimensions – Inches (Millimeters)



**Table 9A – Waffle Tray Dimensions – Inches**

Case Size		2" x 2" Waffle Tray Dimensions – Inches									Packaging Quantity (pcs/unit packaging)
		M	M1	M2	M3	X	Y	Z	A°	MATRIX	
EIA (in)	Metric (mm)	±0.003	±0.003	±0.002	±0.002	±0.002	±0.002	±0.003	± 1/2°	(X x Y)	
0402	1005	0.175	0.153	0.077	0.110	0.073	0.042	0.041	7	16 X 23	368
0504	1210	0.235	0.226	0.172	0.170	0.080	0.090	0.055	5	10 X 10	100
0603	1608	0.175	0.153	0.077	0.110	0.073	0.042	0.041	7	16 X 23	368
0805	2012	0.232	0.186	0.181	0.171	0.062	0.092	0.036	10	10 X 10	100
1005	2512	0.230	0.240	0.190	0.140	0.060	0.110	0.075	5	12 X 9	108
1206 <sup>1,2</sup>	3216	0.194	0.228	0.193	0.124	0.067	0.130	0.065	5	14 X 9	126
1206 <sup>1,3</sup>	3216	0.250	0.250	0.375	0.167	0.100	0.200	0.070	5	10 X 5	50
1210	3225	0.217	0.244	0.215	0.174	0.110	0.145	0.080	5	10 X 8	80
1808	4520	0.271	0.285	0.286	0.243	0.150	0.200	0.075	5	7 X 6	42
1812	4532	0.271	0.285	0.286	0.243	0.150	0.200	0.075	5	7 X 6	42
1825	4564	0.318	0.362	0.424	0.34	0.24	0.32	0.032	5	5 X 4	20
2220	5650	0.318	0.362	0.424	0.34	0.24	0.32	0.032	5	5 X 4	20
2225	5664	0.318	0.362	0.424	0.34	0.24	0.32	0.032	5	5 X 4	20

<sup>1</sup> Packaging of 1206 (3216 metric) case size capacitors is dependent upon the nominal chip thickness of the device. See "Capacitance Range/Selection Waterfall" and "Chip Thickness/Tape & Reel Packaging Quantities" to identify the nominal chip thickness of the capacitor.

<sup>2</sup> Assigned to 1206 (3216 metric) case size capacitors with nominal thickness of ≤ 1.25mm (0.049 inches).

<sup>3</sup> Assigned to 1206 (3216 metric) case size capacitors with nominal thickness of > 1.25mm (0.049 inches).

**Table 9B – Waffle Tray Dimensions – Millimeters**

Case Size		2" x 2" Waffle Tray Dimensions – Millimeters									Packaging Quantity (pcs/unit packaging)
		M	M1	M2	M3	X	Y	Z	A°	MATRIX	
EIA (in)	Metric (mm)	±0.08	±0.08	±0.05	±0.05	±0.05	±0.05	±0.08	± 1/2°	(X x Y)	
0402	1005	4.45	3.89	1.96	2.79	1.85	1.07	1.04	7	16 X 23	368
0504	1210	5.97	5.74	4.37	4.32	2.03	2.29	1.40	5	10 X 10	100
0603	1608	4.45	3.89	1.96	2.79	1.85	1.07	1.04	7	16 X 23	368
0805	2012	5.89	4.72	4.60	4.34	1.57	2.34	0.91	10	10 X 10	100
1005	2512	5.84	6.10	4.83	3.56	1.52	2.79	1.91	5	12 X 9	108
1206 <sup>1,2</sup>	3216	4.93	5.79	4.90	3.15	1.70	3.30	1.65	5	14 X 9	126
1206 <sup>1,3</sup>	3216	6.35	6.35	9.53	4.24	2.54	5.08	1.78	5	10 X 5	50
1210	3225	5.51	6.20	5.46	4.42	2.79	3.68	2.03	5	10 X 8	80
1808	4520	6.88	7.24	7.26	6.17	3.81	5.08	1.91	5	7 X 6	42
1812	4532	6.88	7.24	7.26	6.17	3.81	5.08	1.91	5	7 X 6	42
1825	4564	8.08	9.19	10.77	8.64	6.10	8.13	0.81	5	5 X 4	20
2220	5650	8.08	9.19	10.77	8.64	6.10	8.13	0.81	5	5 X 4	20
2225	5664	8.08	9.19	10.77	8.64	6.10	8.13	0.81	5	5 X 4	20

<sup>1</sup> Packaging of 1206 (3216 metric) case size capacitors is dependent upon the nominal chip thickness of the device. See "Capacitance Range/Selection Waterfall" and "Chip Thickness/Tape & Reel Packaging Quantities" to identify the nominal chip thickness of the capacitor.

<sup>2</sup> Assigned to 1206 (3216 metric) case size capacitors with nominal thickness of ≤ 1.25mm (0.049 inches).

<sup>3</sup> Assigned to 1206 (3216 metric) case size capacitors with nominal thickness of > 1.25mm (0.049 inches).

## KEMET Electronics Corporation Sales Offices

For a complete list of our global sales offices, please visit [www.kemet.com/sales](http://www.kemet.com/sales).

---

### Disclaimer

All product specifications, statements, information and data (collectively, the "Information") in this datasheet are subject to change. The customer is responsible for checking and verifying the extent to which the Information contained in this publication is applicable to an order at the time the order is placed. All Information given herein is believed to be accurate and reliable, but it is presented without guarantee, warranty, or responsibility of any kind, expressed or implied.

Statements of suitability for certain applications are based on KEMET Electronics Corporation's ("KEMET") knowledge of typical operating conditions for such applications, but are not intended to constitute – and KEMET specifically disclaims – any warranty concerning suitability for a specific customer application or use. The Information is intended for use only by customers who have the requisite experience and capability to determine the correct products for their application. Any technical advice inferred from this Information or otherwise provided by KEMET with reference to the use of KEMET's products is given gratis, and KEMET assumes no obligation or liability for the advice given or results obtained.

Although KEMET designs and manufactures its products to the most stringent quality and safety standards, given the current state of the art, isolated component failures may still occur. Accordingly, customer applications which require a high degree of reliability or safety should employ suitable designs or other safeguards (such as installation of protective circuitry or redundancies) in order to ensure that the failure of an electrical component does not result in a risk of personal injury or property damage.

Although all product-related warnings, cautions and notes must be observed, the customer should not assume that all safety measures are indicated or that other measures may not be required.

# Mouser Electronics

Authorized Distributor

Click to View Pricing, Inventory, Delivery & Lifecycle Information:

## KEMET:

[C0603H103J3GACT500](#) [C0805H103J1GACT500](#) [C0805H103J5GACT500](#) [C0805H333J4GACT500](#)  
[C1206H473J5GACT500](#) [C1206H103J1GACT500](#) [C1206H103J5GACT500](#) [C1206H104J3GACT500](#)  
[C1206H473J1GACT500](#) [C1210H104J1GACT500](#) [C1210H104J5GACTU](#) [C1812H104J1GACT500](#)  
[C1812H104J5GACT500](#) [C1812H224J5GACT500](#) [C0805H561J3GACTU](#) [C0805H223J3GACTU](#)  
[C0805H330J5GALT500](#) [C0805H220J5GALT500](#) [C0805H103K3GALT500](#) [C0805H150J5GALT500](#)  
[C0805H822K5GALT500](#) [C1206H821J1GACTU](#) [C0805H103J5GACTU](#) [C0805H220J5GACTU](#) [C0805H102J5GACTU](#)  
[C0805H103J3GACTU](#) [C0603H152J5GACTU](#) [C0603H180J5GACTU](#) [C0603H181J5GACTU](#) [C0603H330J5GACTU](#)  
[C0603H272J5GACTU](#) [C0603H222J5GACTU](#) [C0603H121J5GACTU](#) [C0603H100J5GACTU](#) [C0603H472F1GACTU](#)  
[C0603H102J1GACTU](#) [C0603H332J5GACTU](#) [C0603H101J5GACTU](#) [C0603H331J5GACTU](#) [C0603H821J5GACTU](#)  
[C0603H820J5GACTU](#) [C0603H751J5GACTU](#) [C0603H680J5GACTU](#) [C0603H621J5GACTU](#) [C0603H560J5GACTU](#)  
[C0603H472J1GACTU](#) [C0603H390J5GACTU](#) [C0805H101K5GACTU](#) [C0805H101G5GACTU](#) [C0805H100K5GACTU](#)  
[C0805H100J1GACTU](#) [C0805H102J1GACTU](#) [C0805H470J3GACTU](#) [C0805H682J3GACTU](#) [C0805H821J3GACTU](#)  
[C0805H822K5GALTU](#) [C0805H472J1GACTU](#) [C0805H221J3GACTU](#) [C0805H102K3GALTU](#) [C0805H103K3GACTU](#)  
[C0805H103K3GALTU](#) [C0805H121J5GACTU](#) [C0805H122J3GACTU](#) [C0805H123J3GACTU](#) [C0805H150J5GALTU](#)  
[C0805H152J5GACTU](#) [C0805H180J5GACTU](#) [C0805H680J3GACTU](#) [C0805H220J5GALTU](#) [C0805H621J3GACTU](#)  
[C0805H222J1GACTU](#) [C0805H222K5GALTU](#) [C0805H223J5GACTU](#) [C0805H272J1GACTU](#) [C0805H330J3GACTU](#)  
[C0805H330J5GALTU](#) [C0805H471J1GACTU](#) [C0805H471J3GACTU](#) [C0805H102J3GACTU](#) [C0805H200J1GACTU](#)  
[C1206H103K3GACTU](#) [C1206H120J5GACTU](#) [C1206H122J1GACTU](#) [C1206H122J5GACTU](#) [C1206H123J5GACTU](#)  
[C1206H151J1GACTU](#) [C1206H151J5GACTU](#) [C1206H180J5GACTU](#) [C1206H202G5GACTU](#) [C1206H183J5GACTU](#)  
[C1206H183J1GACTU](#) [C1206H182J5GACTU](#) [C1206H182J1GACTU](#) [C1206H181J5GACTU](#) [C1206H153J5GACTU](#)  
[C1206H100J5GACTU](#) [C1206H101J1GACTU](#) [C1206H101J5GACTU](#) [C1206H829J5GACTU](#) [C1206H102J5GACTU](#)