

# Low Voltage, Rail-to-Rail Operational Amplifiers

## MC33201, MC33202, MC33204, NCV33201, NCV33202, NCV33204

The MC33201/2/4 family of operational amplifiers provide rail-to-rail operation on both the input and output. The inputs can be driven as high as 200 mV beyond the supply rails without phase reversal on the outputs, and the output can swing within 50 mV of each rail. This rail-to-rail operation enables the user to make full use of the supply voltage range available. It is designed to work at very low supply voltages ( $\pm 0.9$  V) yet can operate with a supply of up to +12 V and ground. Output current boosting techniques provide a high output current capability while keeping the drain current of the amplifier to a minimum. Also, the combination of low noise and distortion with a high slew rate and drive capability make this an ideal amplifier for audio applications.

### Features

- Low Voltage, Single Supply Operation (+1.8 V and Ground to +12 V and Ground)
- Input Voltage Range Includes both Supply Rails
- Output Voltage Swings within 50 mV of both Rails
- No Phase Reversal on the Output for Over-driven Input Signals
- High Output Current ( $I_{SC} = 80$  mA, Typ)
- Low Supply Current ( $I_D = 0.9$  mA, Typ)
- 600  $\Omega$  Output Drive Capability
- Extended Operating Temperature Ranges ( $-40^\circ$  to  $+105^\circ\text{C}$  and  $-55^\circ$  to  $+125^\circ\text{C}$ )
- Typical Gain Bandwidth Product = 2.2 MHz
- NCV Prefix for Automotive and Other Applications Requiring Unique Site and Control Change Requirements; AEC-Q100 Qualified and PPAP Capable
- These Devices are Pb-Free and are RoHS Compliant



SOIC-8  
D, VD SUFFIX  
CASE 751



Micro8  
DM SUFFIX  
CASE 846A

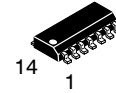

SOIC-14  
D, VD SUFFIX  
CASE 751A



TSSOP-14  
DTB SUFFIX  
CASE 948G

### ORDERING INFORMATION

See detailed ordering and shipping information in the package dimensions section on page 10 of this data sheet.

### DEVICE MARKING INFORMATION

See general marking information in the device marking section on page 10 of this data sheet.

PIN CONNECTIONS

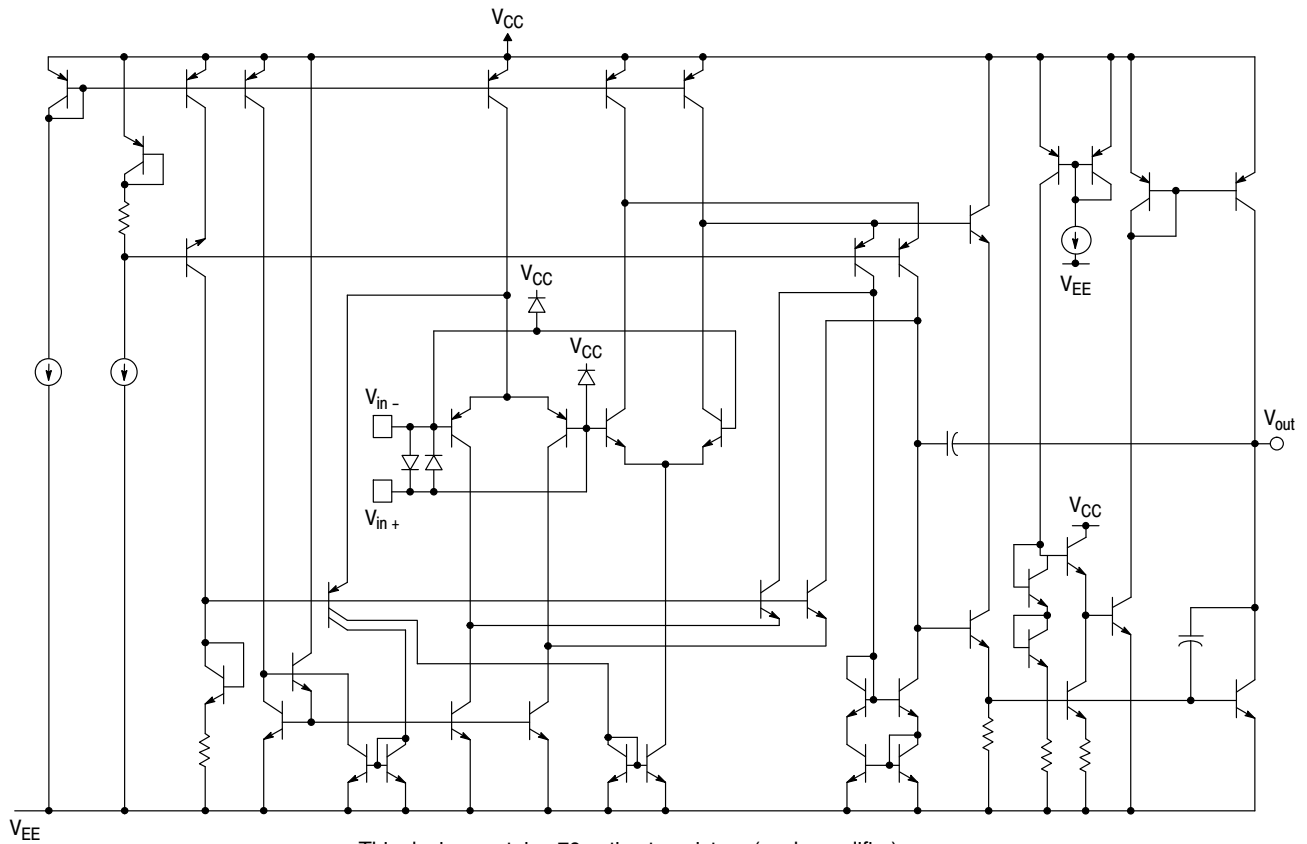
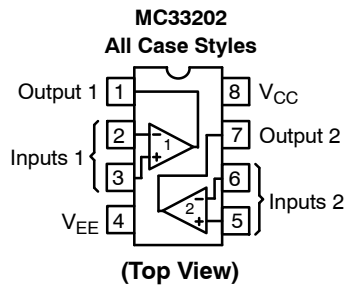
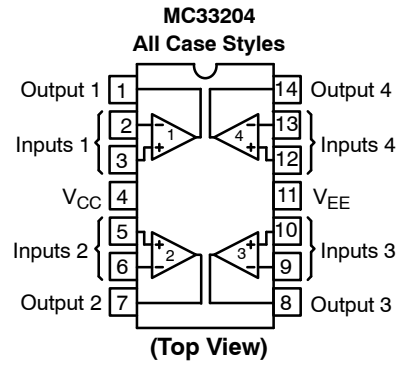
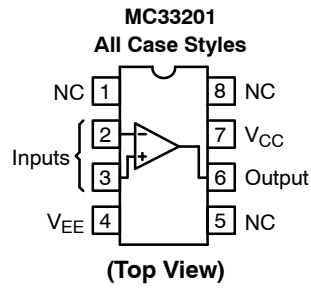

Figure 1. Circuit Schematic  
(Each Amplifier)

# MC33201, MC33202, MC33204, NCV33201, NCV33202, NCV33204

## MAXIMUM RATINGS

Rating	Symbol	Value	Unit
Supply Voltage ( $V_{CC}$ to $V_{EE}$ )	$V_S$	+13	V
Input Differential Voltage Range	$V_{IDR}$	Note 1	V
Common Mode Input Voltage Range (Note 2)	$V_{CM}$	$V_{CC} + 0.5$ V to $V_{EE} - 0.5$ V	V
Output Short Circuit Duration	$t_s$	Note 3	sec
Maximum Junction Temperature	$T_J$	+150	°C
Storage Temperature	$T_{stg}$	- 65 to +150	°C
Maximum Power Dissipation	$P_D$	Note 3	mW

## DC ELECTRICAL CHARACTERISTICS ( $T_A = 25^\circ\text{C}$ )

Characteristic	$V_{CC} = 2.0$ V	$V_{CC} = 3.3$ V	$V_{CC} = 5.0$ V	Unit
Input Offset Voltage $V_{IO}$ (max) MC33201, NCV33201V MC33202, NCV33202, V MC33204, NCV33204, V	$\pm 8.0$ $\pm 10$ $\pm 12$	$\pm 8.0$ $\pm 10$ $\pm 12$	$\pm 6.0$ $\pm 8.0$ $\pm 10$	mV
Output Voltage Swing $V_{OH}$ ( $R_L = 10$ k $\Omega$ ) $V_{OL}$ ( $R_L = 10$ k $\Omega$ )	1.9 0.10	3.15 0.15	4.85 0.15	$V_{min}$ $V_{max}$
Power Supply Current per Amplifier ( $I_D$ )	1.125	1.125	1.125	mA

Specifications at  $V_{CC} = 3.3$  V are guaranteed by the 2.0 V and 5.0 V tests.  $V_{EE} = \text{GND}$ .

## DC ELECTRICAL CHARACTERISTICS ( $V_{CC} = +5.0$ V, $V_{EE} = \text{Ground}$ , $T_A = 25^\circ\text{C}$ , unless otherwise noted.)

Characteristic	Figure	Symbol	Min	Typ	Max	Unit
Input Offset Voltage ( $V_{CM} = 0$ V to 0.5 V, $V_{CM} = 1.0$ V to 5.0 V) MC33201/NCV33201V: $T_A = +25^\circ\text{C}$ MC33201: $T_A = -40^\circ$ to $+105^\circ\text{C}$ MC33201V/NCV33201V: $T_A = -55^\circ$ to $+125^\circ\text{C}$ MC33202/NCV33202, V: $T_A = +25^\circ\text{C}$ MC33202/NCV33202: $T_A = -40^\circ$ to $+105^\circ\text{C}$ MC33202V/NCV33202V: $T_A = -55^\circ$ to $+125^\circ\text{C}$ (Note 4) MC33204/NCV33204V: $T_A = +25^\circ\text{C}$ MC33204: $T_A = -40^\circ$ to $+105^\circ\text{C}$ MC33204V/NCV33204V: $T_A = -55^\circ$ to $+125^\circ\text{C}$ (Note 4)	3	$ V_{IO} $	- - - - - - - -	- - - - - - - -	6.0 9.0 13 8.0 11 14 10 13 17	mV
Input Offset Voltage Temperature Coefficient ( $R_S = 50$ $\Omega$ ) $T_A = -40^\circ$ to $+105^\circ\text{C}$ $T_A = -55^\circ$ to $+125^\circ\text{C}$	4	$\Delta V_{IO}/\Delta T$	- -	2.0 2.0	- -	$\mu\text{V}/^\circ\text{C}$
Input Bias Current ( $V_{CM} = 0$ V to 0.5 V, $V_{CM} = 1.0$ V to 5.0 V) $T_A = +25^\circ\text{C}$ $T_A = -40^\circ$ to $+105^\circ\text{C}$ $T_A = -55^\circ$ to $+125^\circ\text{C}$	5, 6	$ I_{IB} $	- - -	80 100 -	200 250 500	nA

Stresses exceeding those listed in the Maximum Ratings table may damage the device. If any of these limits are exceeded, device functionality should not be assumed, damage may occur and reliability may be affected.

- The differential input voltage of each amplifier is limited by two internal parallel back-to-back diodes. For additional differential input voltage range, use current limiting resistors in series with the input pins.
- The input common mode voltage range is limited by internal diodes connected from the inputs to both supply rails. Therefore, the voltage on either input must not exceed either supply rail by more than 500 mV.
- Power dissipation must be considered to ensure maximum junction temperature ( $T_J$ ) is not exceeded. (See Figure 2)
- All NCV devices are qualified for Automotive use.

# MC33201, MC33202, MC33204, NCV33201, NCV33202, NCV33204

## DC ELECTRICAL CHARACTERISTICS (cont.) ( $V_{CC} = +5.0\text{ V}$ , $V_{EE} = \text{Ground}$ , $T_A = 25^\circ\text{C}$ , unless otherwise noted.)

Characteristic	Figure	Symbol	Min	Typ	Max	Unit
Input Offset Current ( $V_{CM} = 0\text{ V to } 0.5\text{ V}$ , $V_{CM} = 1.0\text{ V to } 5.0\text{ V}$ ) $T_A = +25^\circ\text{C}$ $T_A = -40^\circ\text{ to } +105^\circ\text{C}$ $T_A = -55^\circ\text{ to } +125^\circ\text{C}$	–	$ I_{IO} $	–	5.0 10 –	50 100 200	nA
Common Mode Input Voltage Range	–	$V_{ICR}$	$V_{EE}$	–	$V_{CC}$	V
Large Signal Voltage Gain ( $V_{CC} = +5.0\text{ V}$ , $V_{EE} = -5.0\text{ V}$ ) $R_L = 10\text{ k}\Omega$ $R_L = 600\ \Omega$	7	$A_{VOL}$	50 25	300 250	– –	kV/V
Output Voltage Swing ( $V_{ID} = \pm 0.2\text{ V}$ ) $R_L = 10\text{ k}\Omega$ $R_L = 10\text{ k}\Omega$ $R_L = 600\ \Omega$ $R_L = 600\ \Omega$	8, 9, 10	$V_{OH}$ $V_{OL}$ $V_{OH}$ $V_{OL}$	4.85 – 4.75 –	4.95 0.05 4.85 0.15	– 0.15 – 0.25	V
Common Mode Rejection ( $V_{in} = 0\text{ V to } 5.0\text{ V}$ )	11	CMR	60	90	–	dB
Power Supply Rejection Ratio $V_{CC}/V_{EE} = 5.0\text{ V/GND to } 3.0\text{ V/GND}$	12	PSRR	500	25	–	$\mu\text{V/V}$
Output Short Circuit Current (Source and Sink)	13, 14	$I_{SC}$	50	80	–	mA
Power Supply Current per Amplifier ( $V_O = 0\text{ V}$ ) $T_A = -40^\circ\text{ to } +105^\circ\text{C}$ $T_A = -55^\circ\text{ to } +125^\circ\text{C}$	15	$I_D$	– –	0.9 0.9	1.125 1.125	mA

## AC ELECTRICAL CHARACTERISTICS ( $V_{CC} = +5.0\text{ V}$ , $V_{EE} = \text{Ground}$ , $T_A = 25^\circ\text{C}$ , unless otherwise noted.)

Characteristic	Figure	Symbol	Min	Typ	Max	Unit
Slew Rate ( $V_S = \pm 2.5\text{ V}$ , $V_O = -2.0\text{ V to } +2.0\text{ V}$ , $R_L = 2.0\text{ k}\Omega$ , $A_V = +1.0$ )	16, 26	SR	0.5	1.0	–	V/ $\mu\text{s}$
Gain Bandwidth Product ( $f = 100\text{ kHz}$ )	17	GBW	–	2.2	–	MHz
Gain Margin ( $R_L = 600\ \Omega$ , $C_L = 0\text{ pF}$ )	20, 21, 22	$A_M$	–	12	–	dB
Phase Margin ( $R_L = 600\ \Omega$ , $C_L = 0\text{ pF}$ )	20, 21, 22	$\theta_M$	–	65	–	Deg
Channel Separation ( $f = 1.0\text{ Hz to } 20\text{ kHz}$ , $A_V = 100$ )	23	CS	–	90	–	dB
Power Bandwidth ( $V_O = 4.0\text{ V}_{pp}$ , $R_L = 600\ \Omega$ , $\text{THD} \leq 1\%$ )		$BW_P$	–	28	–	kHz
Total Harmonic Distortion ( $R_L = 600\ \Omega$ , $V_O = 1.0\text{ V}_{pp}$ , $A_V = 1.0$ ) $f = 1.0\text{ kHz}$ $f = 10\text{ kHz}$	24	THD	– –	0.002 0.008	– –	%
Open Loop Output Impedance ( $V_O = 0\text{ V}$ , $f = 2.0\text{ MHz}$ , $A_V = 10$ )		$ Z_O $	–	100	–	$\Omega$
Differential Input Resistance ( $V_{CM} = 0\text{ V}$ )		$R_{in}$	–	200	–	k $\Omega$
Differential Input Capacitance ( $V_{CM} = 0\text{ V}$ )		$C_{in}$	–	8.0	–	pF
Equivalent Input Noise Voltage ( $R_S = 100\ \Omega$ ) $f = 10\text{ Hz}$ $f = 1.0\text{ kHz}$	25	$e_n$	– –	25 20	– –	nV/ $\sqrt{\text{Hz}}$
Equivalent Input Noise Current $f = 10\text{ Hz}$ $f = 1.0\text{ kHz}$	25	$i_n$	– –	0.8 0.2	– –	pA/ $\sqrt{\text{Hz}}$

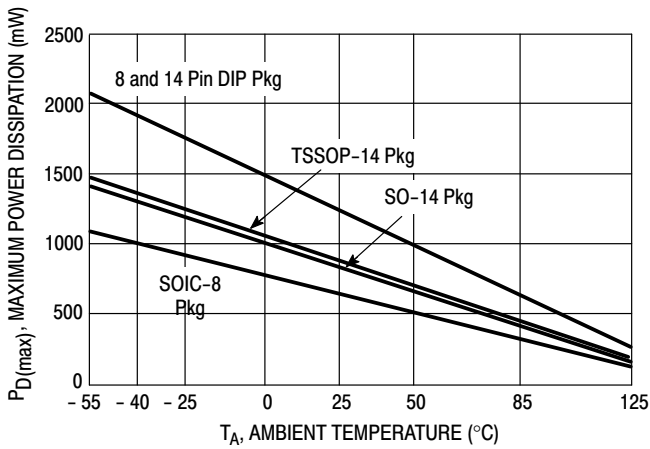

Figure 2. Maximum Power Dissipation versus Temperature

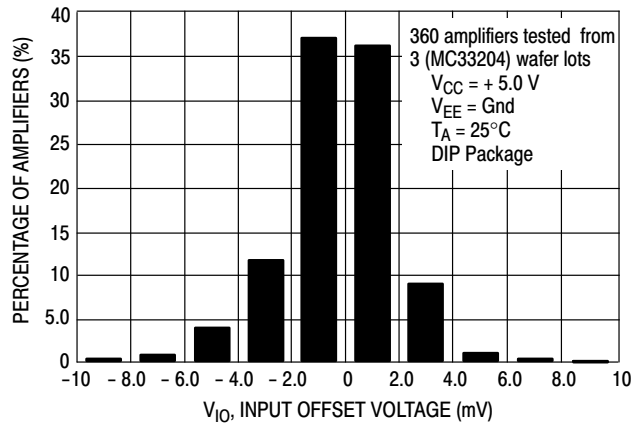

Figure 3. Input Offset Voltage Distribution

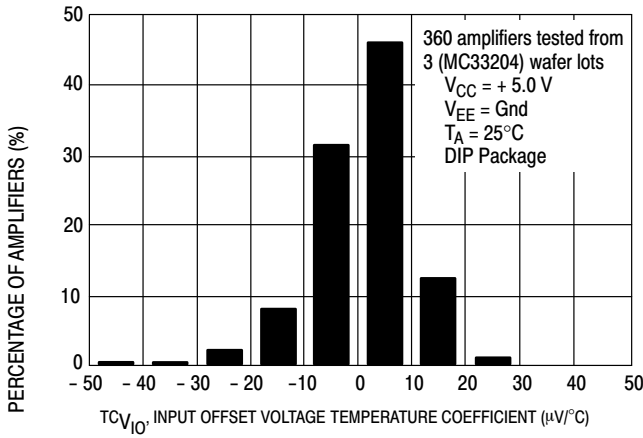

Figure 4. Input Offset Voltage Temperature Coefficient Distribution

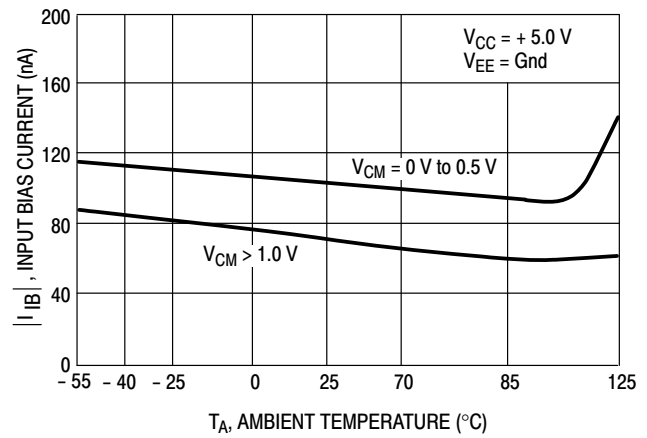

Figure 5. Input Bias Current versus Temperature

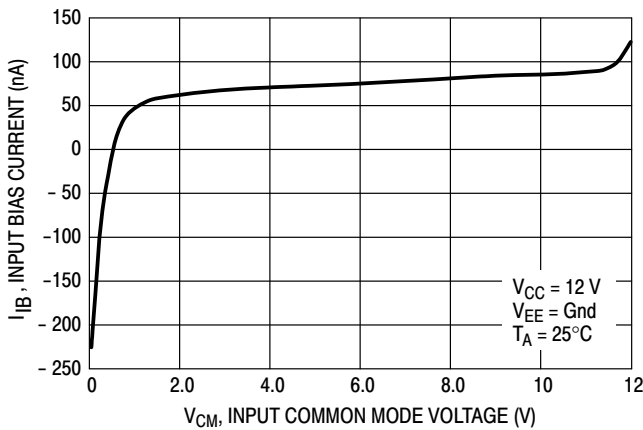

Figure 6. Input Bias Current versus Common Mode Voltage

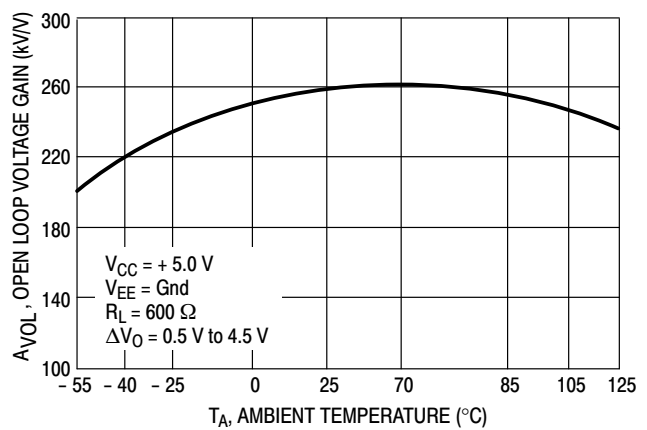

Figure 7. Open Loop Voltage Gain versus Temperature

MC33201, MC33202, MC33204, NCV33201, NCV33202, NCV33204

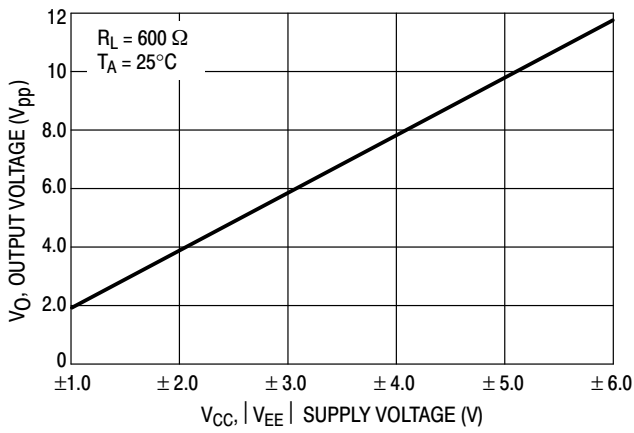

Figure 8. Output Voltage Swing versus Supply Voltage

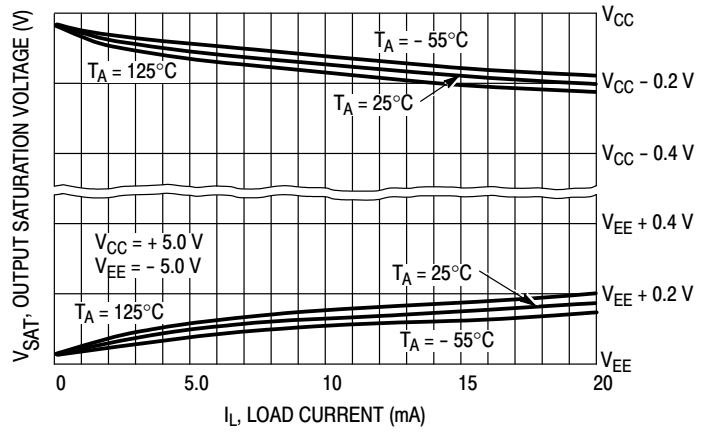

Figure 9. Output Saturation Voltage versus Load Current

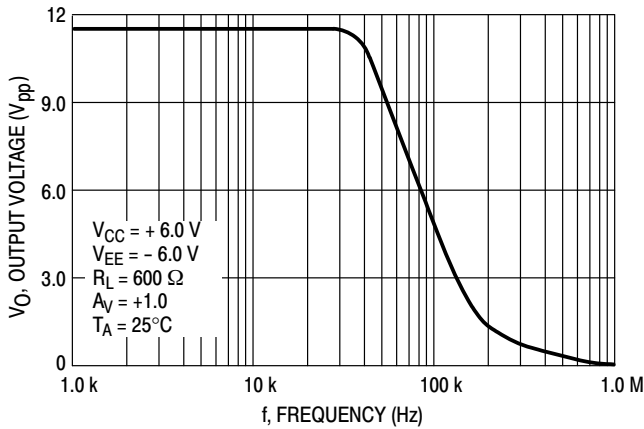

Figure 10. Output Voltage versus Frequency

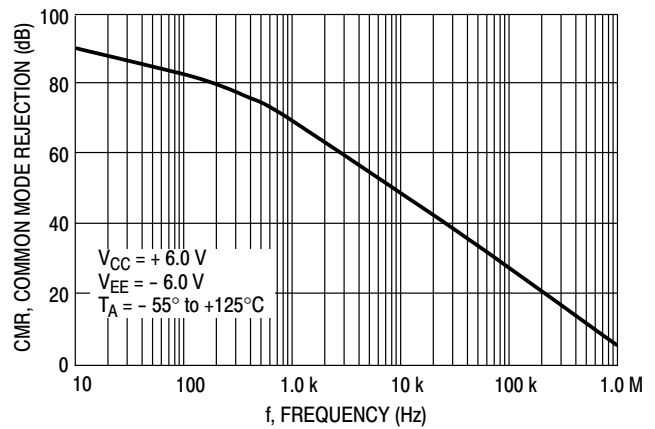

Figure 11. Common Mode Rejection versus Frequency

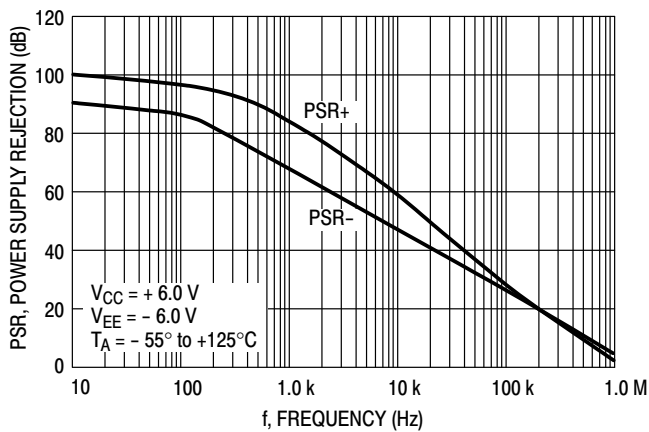

Figure 12. Power Supply Rejection versus Frequency

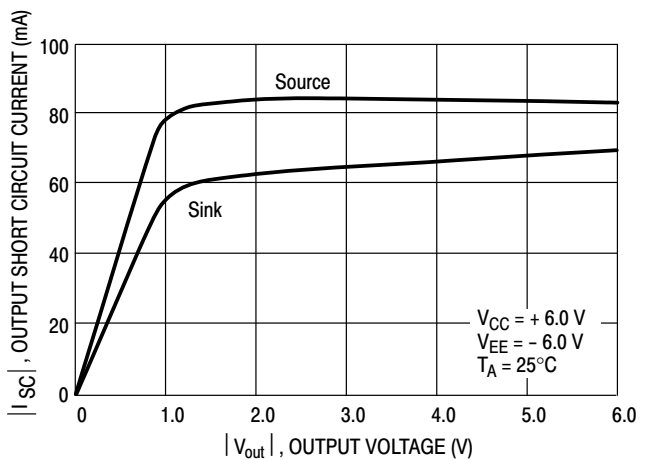

Figure 13. Output Short Circuit Current versus Output Voltage

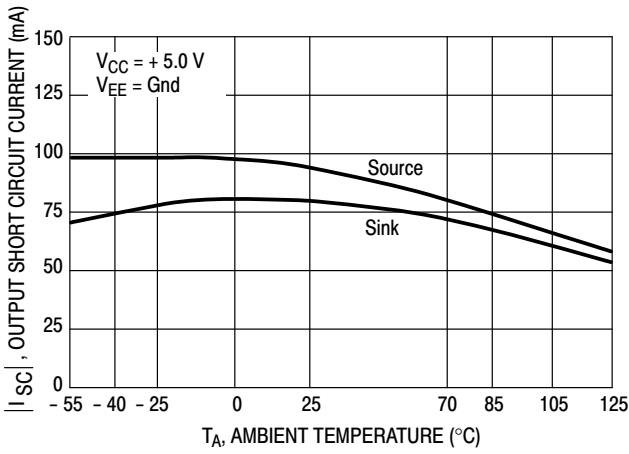

Figure 14. Output Short Circuit Current versus Temperature

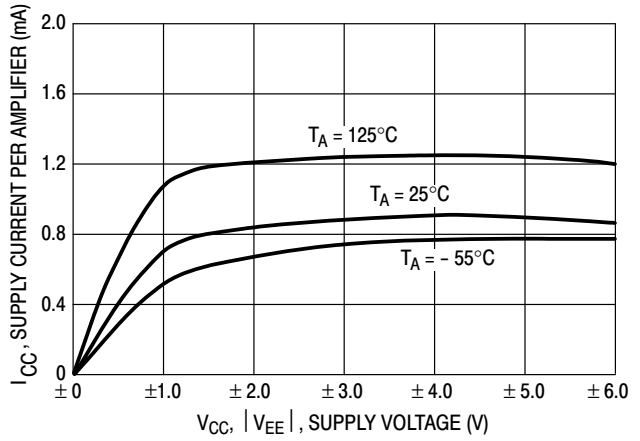

Figure 15. Supply Current per Amplifier versus Supply Voltage with No Load

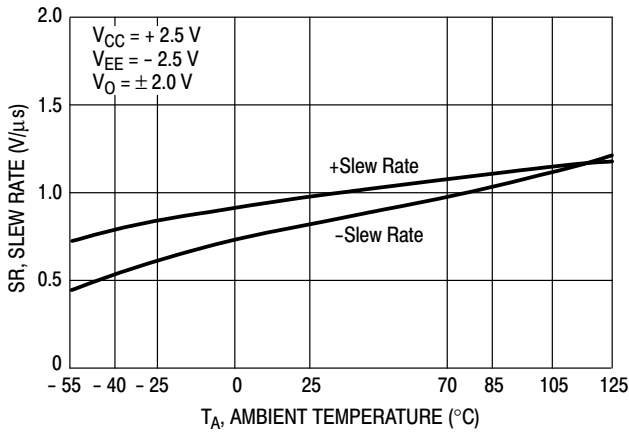

Figure 16. Slew Rate versus Temperature

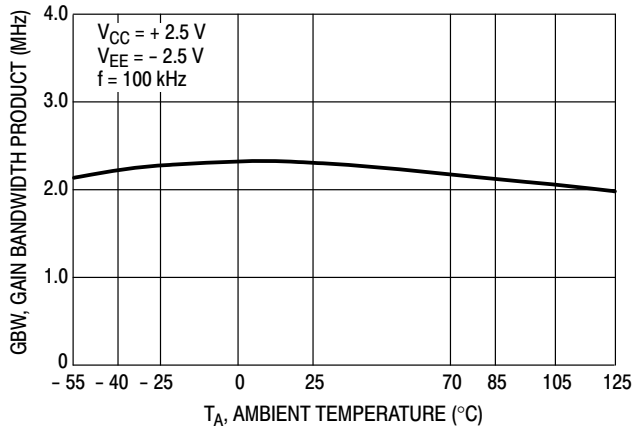

Figure 17. Gain Bandwidth Product versus Temperature

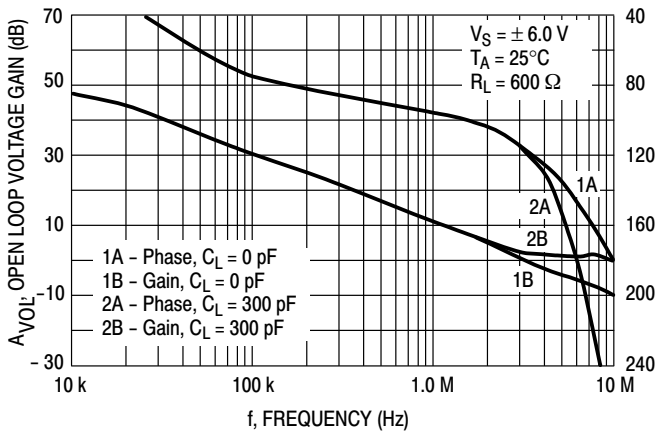

Figure 18. Voltage Gain and Phase versus Frequency

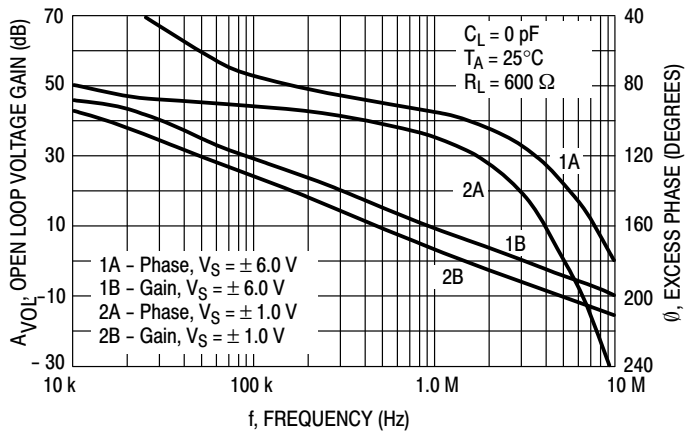

Figure 19. Voltage Gain and Phase versus Frequency

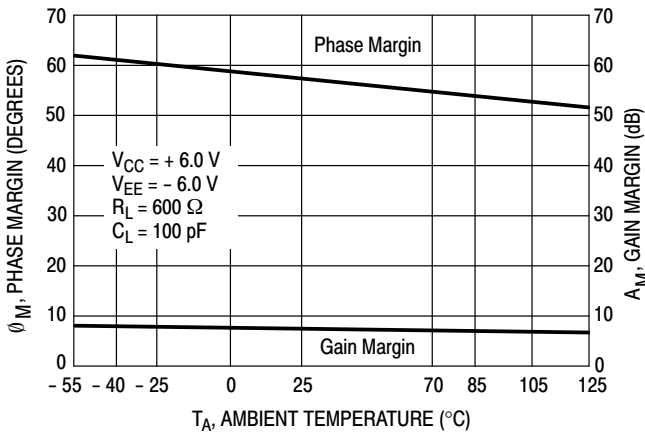

Figure 20. Gain and Phase Margin versus Temperature

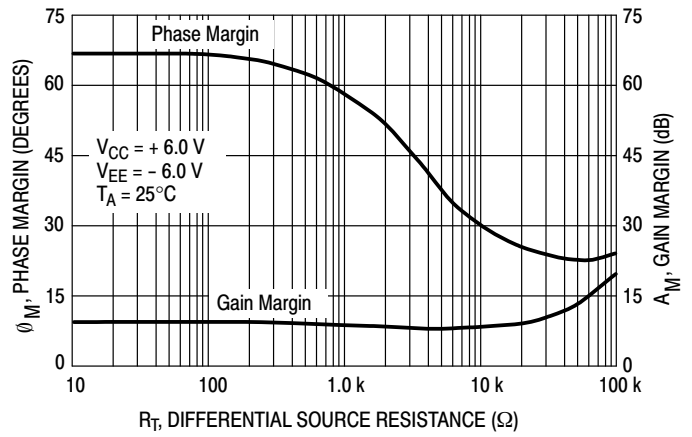

Figure 21. Gain and Phase Margin versus Differential Source Resistance

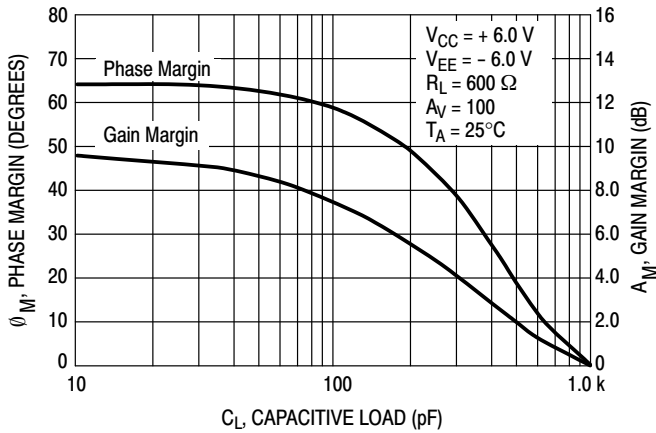

Figure 22. Gain and Phase Margin versus Capacitive Load

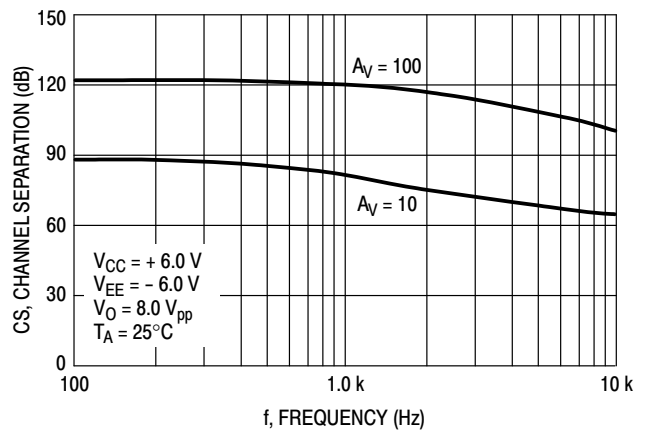

Figure 23. Channel Separation versus Frequency

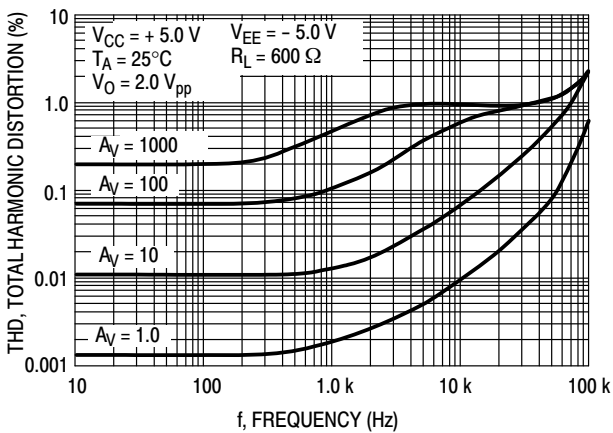

Figure 24. Total Harmonic Distortion versus Frequency

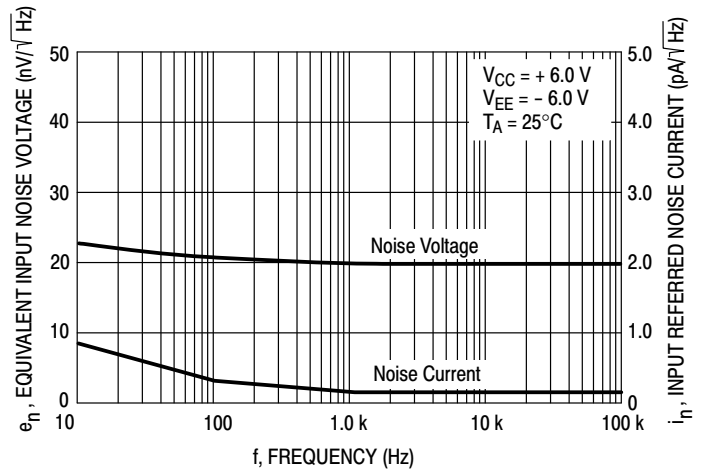

Figure 25. Equivalent Input Noise Voltage and Current versus Frequency



DETAILED OPERATING DESCRIPTION

General Information

The MC33201/2/4 family of operational amplifiers are unique in their ability to swing rail-to-rail on both the input and the output with a completely bipolar design. This offers low noise, high output current capability and a wide common mode input voltage range even with low supply voltages. Operation is guaranteed over an extended temperature range and at supply voltages of 2.0 V, 3.3 V and 5.0 V and ground.

Since the common mode input voltage range extends from  $V_{CC}$  to  $V_{EE}$ , it can be operated with either single or split voltage supplies. The MC33201/2/4 are guaranteed not to latch or phase reverse over the entire common mode range, however, the inputs should not be allowed to exceed maximum ratings.

Circuit Information

Rail-to-rail performance is achieved at the input of the amplifiers by using parallel NPN-PNP differential input stages. When the inputs are within 800 mV of the negative rail, the PNP stage is on. When the inputs are more than 800 mV greater than  $V_{EE}$ , the NPN stage is on. This switching of input pairs will cause a reversal of input bias currents (see Figure 6). Also, slight differences in offset voltage may be noted between the NPN and PNP pairs. Cross-coupling techniques have been used to keep this change to a minimum.

In addition to its rail-to-rail performance, the output stage is current boosted to provide 80 mA of output current, enabling the op amp to drive 600  $\Omega$  loads. Because of this high output current capability, care should be taken not to exceed the 150°C maximum junction temperature.

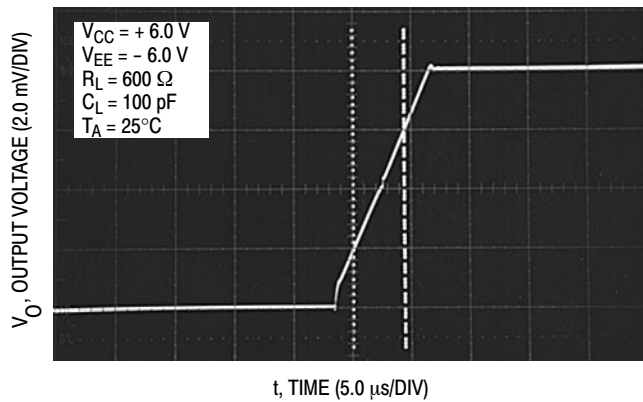

Figure 26. Noninverting Amplifier Slew Rate

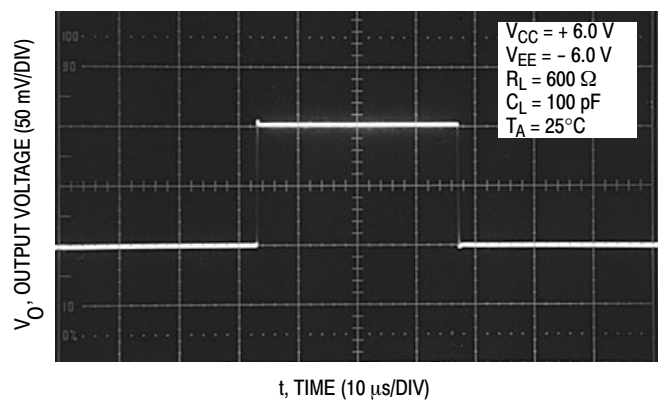

Figure 27. Small Signal Transient Response

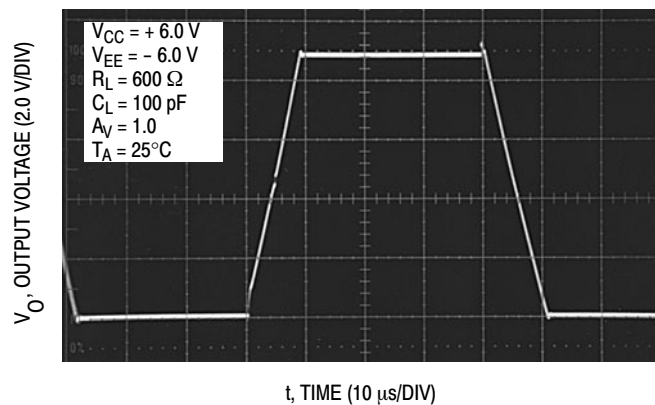

Figure 28. Large Signal Transient Response

Surface mount board layout is a critical portion of the total design. The footprint for the semiconductor packages must be the correct size to ensure proper solder connection interface

between the board and the package. With the correct pad geometry, the packages will self-align when subjected to a solder reflow process.

ORDERING INFORMATION

Operational Amplifier Function	Device	Operating Temperature Range	Package	Shipping†
Single	MC33201DR2G	$T_A = -40^\circ$ to $+105^\circ\text{C}$	SOIC-8 (Pb-Free)	2500 / Tape & Reel
	MC33201VDR2G	$T_A = -55^\circ$ to $125^\circ\text{C}$		2500 / Tape & Reel
	NCV33201VDR2G			2500 / Tape & Reel
Dual	MC33202DR2G	$T_A = -40^\circ$ to $+105^\circ\text{C}$	SOIC-8 (Pb-Free)	2500 / Tape & Reel
	MC33202DMR2G		Micro-8 (Pb-Free)	4000 / Tape & Reel
	NCV33202DMR2G*			
	MC33202VDR2G	$T_A = -55^\circ$ to $125^\circ\text{C}$	SOIC-8 (Pb-Free)	2500 / Tape & Reel
	NCV33202VDR2G*			
Quad	MC33204DR2G	$T_A = -40^\circ$ to $+105^\circ\text{C}$	SO-14 (Pb-Free)	2500 Units / Tape & Reel
	MC33204DTBR2G		TSSOP-14 (Pb-Free)	2500 Units / Tape & Reel
	NCV33204DR2G*	$T_A = -55^\circ$ to $125^\circ\text{C}$	SO-14 (Pb-Free)	2500 Units / Tape & Reel
	NCV33204DTBR2G*		TSSOP-14 (Pb-Free)	2500 Units / Tape & Reel

†For information on tape and reel specifications, including part orientation and tape sizes, please refer to our Tape and Reel Packaging Specifications Brochure, [BRD8011/D](#).

\*NCV Prefix for Automotive and Other Applications Requiring Unique Site and Control Change Requirements; AEC-Q100 Qualified and PPAP Capable.

MARKING DIAGRAMS

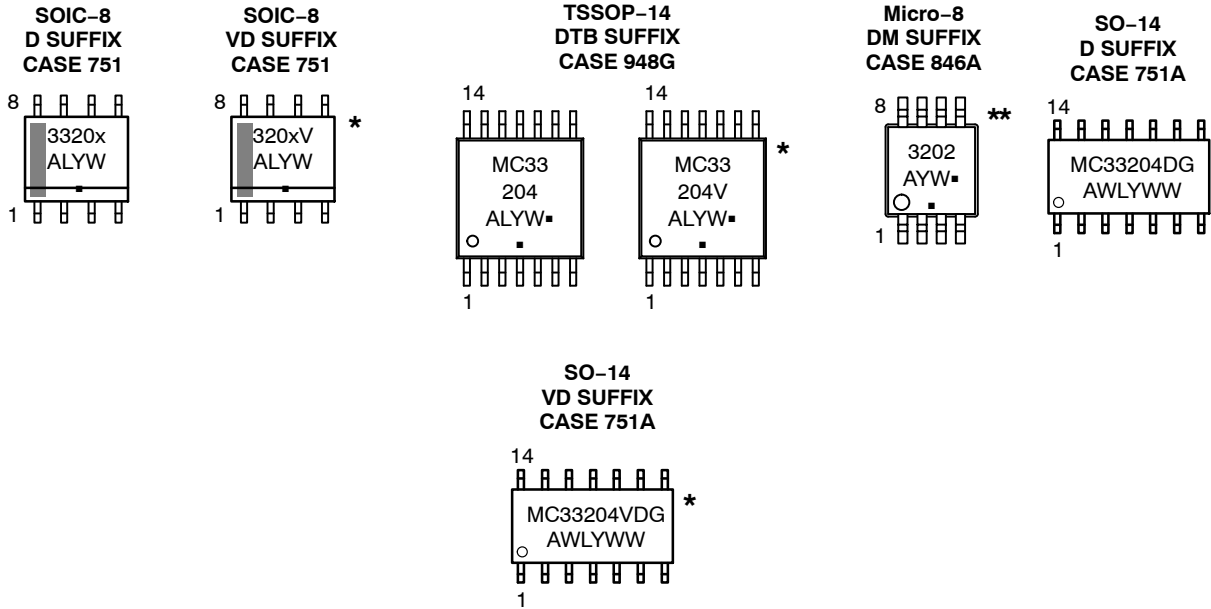

- x = 1 or 2
  - A = Assembly Location
  - WL, L = Wafer Lot
  - YY, Y = Year
  - WW, W = Work Week
  - G = Pb-Free Package
  - = Pb-Free Package
- (Note: Microdot may be in either location)

\*This marking diagram applies to NCV3320xV

\*\*This marking diagram applies to NCV33202DMR2G

# MECHANICAL CASE OUTLINE PACKAGE DIMENSIONS



SCALE 1:1

SOIC-8 NB  
CASE 751-07  
ISSUE AK

DATE 16 FEB 2011

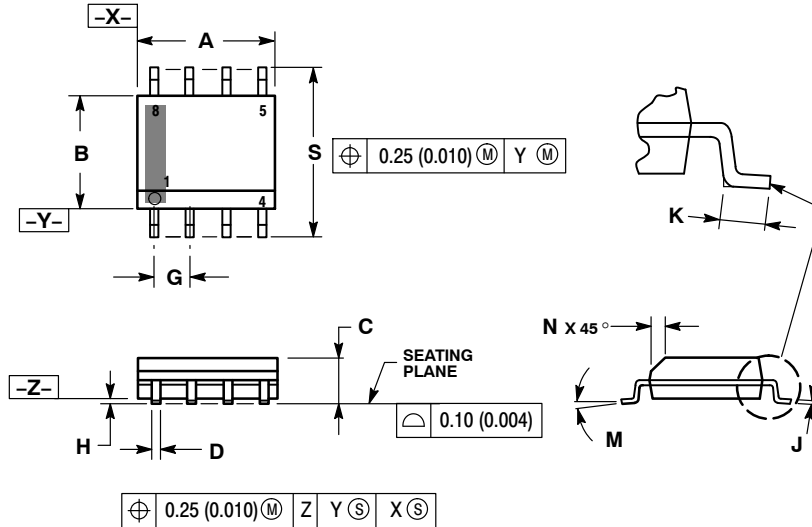

- NOTES:
1. DIMENSIONING AND TOLERANCING PER ANSI Y14.5M, 1982.
  2. CONTROLLING DIMENSION: MILLIMETER.
  3. DIMENSION A AND B DO NOT INCLUDE MOLD PROTRUSION.
  4. MAXIMUM MOLD PROTRUSION 0.15 (0.006) PER SIDE.
  5. DIMENSION D DOES NOT INCLUDE DAMBAR PROTRUSION. ALLOWABLE DAMBAR PROTRUSION SHALL BE 0.127 (0.005) TOTAL IN EXCESS OF THE D DIMENSION AT MAXIMUM MATERIAL CONDITION.
  6. 751-01 THRU 751-06 ARE OBSOLETE. NEW STANDARD IS 751-07.

DIM	MILLIMETERS		INCHES	
	MIN	MAX	MIN	MAX
A	4.80	5.00	0.189	0.197
B	3.80	4.00	0.150	0.157
C	1.35	1.75	0.053	0.069
D	0.33	0.51	0.013	0.020
G	1.27 BSC		0.050 BSC	
H	0.10	0.25	0.004	0.010
J	0.19	0.25	0.007	0.010
K	0.40	1.27	0.016	0.050
M	0°	8°	0°	8°
N	0.25	0.50	0.010	0.020
S	5.80	6.20	0.228	0.244

### SOLDERING FOOTPRINT\*

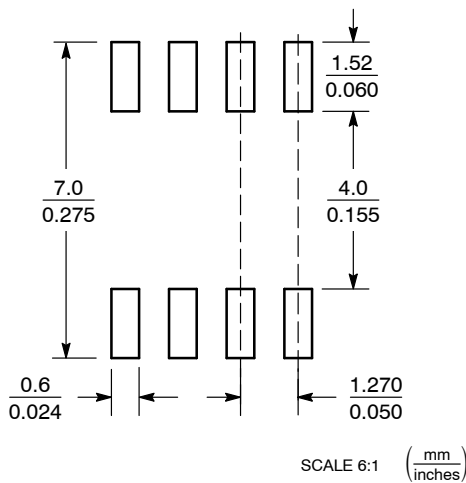

\*For additional information on our Pb-Free strategy and soldering details, please download the ON Semiconductor Soldering and Mounting Techniques Reference Manual, SOLDERRM/D.

### GENERIC MARKING DIAGRAM\*



XXXXXX = Specific Device Code  
A = Assembly Location  
L = Wafer Lot  
Y = Year  
W = Work Week  
▪ = Pb-Free Package

XXXXXX = Specific Device Code  
A = Assembly Location  
Y = Year  
WW = Work Week  
▪ = Pb-Free Package

\*This information is generic. Please refer to device data sheet for actual part marking. Pb-Free indicator, "G" or microdot "▪", may or may not be present. Some products may not follow the Generic Marking.

### STYLES ON PAGE 2

DOCUMENT NUMBER:	98ASB42564B	Electronic versions are uncontrolled except when accessed directly from the Document Repository. Printed versions are uncontrolled except when stamped "CONTROLLED COPY" in red.
DESCRIPTION:	SOIC-8 NB	PAGE 1 OF 2

onsemi and ONsemi are trademarks of Semiconductor Components Industries, LLC dba onsemi or its subsidiaries in the United States and/or other countries. onsemi reserves the right to make changes without further notice to any products herein. onsemi makes no warranty, representation or guarantee regarding the suitability of its products for any particular purpose, nor does onsemi assume any liability arising out of the application or use of any product or circuit, and specifically disclaims any and all liability, including without limitation special, consequential or incidental damages. onsemi does not convey any license under its patent rights nor the rights of others.

**SOIC-8 NB**  
**CASE 751-07**  
**ISSUE AK**

DATE 16 FEB 2011

- |  |   |   |   |
|--|---|---|---|
| <p><b>STYLE 1:</b><br/>         PIN 1. EMITTER<br/>         2. COLLECTOR<br/>         3. COLLECTOR<br/>         4. EMITTER<br/>         5. EMITTER<br/>         6. BASE<br/>         7. BASE<br/>         8. EMITTER</p>   | <p><b>STYLE 2:</b><br/>         PIN 1. COLLECTOR, DIE, #1<br/>         2. COLLECTOR, #1<br/>         3. COLLECTOR, #2<br/>         4. COLLECTOR, #2<br/>         5. BASE, #2<br/>         6. EMITTER, #2<br/>         7. BASE, #1<br/>         8. EMITTER, #1</p>               | <p><b>STYLE 3:</b><br/>         PIN 1. DRAIN, DIE #1<br/>         2. DRAIN, #1<br/>         3. DRAIN, #2<br/>         4. DRAIN, #2<br/>         5. GATE, #2<br/>         6. SOURCE, #2<br/>         7. GATE, #1<br/>         8. SOURCE, #1</p>                            | <p><b>STYLE 4:</b><br/>         PIN 1. ANODE<br/>         2. ANODE<br/>         3. ANODE<br/>         4. ANODE<br/>         5. ANODE<br/>         6. ANODE<br/>         7. ANODE<br/>         8. COMMON CATHODE</p>   |
| <p><b>STYLE 5:</b><br/>         PIN 1. DRAIN<br/>         2. DRAIN<br/>         3. DRAIN<br/>         4. DRAIN<br/>         5. GATE<br/>         6. GATE<br/>         7. SOURCE<br/>         8. SOURCE</p>   | <p><b>STYLE 6:</b><br/>         PIN 1. SOURCE<br/>         2. DRAIN<br/>         3. DRAIN<br/>         4. SOURCE<br/>         5. SOURCE<br/>         6. GATE<br/>         7. GATE<br/>         8. SOURCE</p>  | <p><b>STYLE 7:</b><br/>         PIN 1. INPUT<br/>         2. EXTERNAL BYPASS<br/>         3. THIRD STAGE SOURCE<br/>         4. GROUND<br/>         5. DRAIN<br/>         6. GATE 3<br/>         7. SECOND STAGE Vd<br/>         8. FIRST STAGE Vd</p>                    | <p><b>STYLE 8:</b><br/>         PIN 1. COLLECTOR, DIE #1<br/>         2. BASE, #1<br/>         3. BASE, #2<br/>         4. COLLECTOR, #2<br/>         5. COLLECTOR, #2<br/>         6. EMITTER, #2<br/>         7. EMITTER, #1<br/>         8. COLLECTOR, #1</p>                              |
| <p><b>STYLE 9:</b><br/>         PIN 1. EMITTER, COMMON<br/>         2. COLLECTOR, DIE #1<br/>         3. COLLECTOR, DIE #2<br/>         4. EMITTER, COMMON<br/>         5. EMITTER, COMMON<br/>         6. BASE, DIE #2<br/>         7. BASE, DIE #1<br/>         8. EMITTER, COMMON</p> | <p><b>STYLE 10:</b><br/>         PIN 1. GROUND<br/>         2. BIAS 1<br/>         3. OUTPUT<br/>         4. GROUND<br/>         5. GROUND<br/>         6. BIAS 2<br/>         7. INPUT<br/>         8. GROUND</p>  | <p><b>STYLE 11:</b><br/>         PIN 1. SOURCE 1<br/>         2. GATE 1<br/>         3. SOURCE 2<br/>         4. GATE 2<br/>         5. DRAIN 2<br/>         6. DRAIN 2<br/>         7. DRAIN 1<br/>         8. DRAIN 1</p>   | <p><b>STYLE 12:</b><br/>         PIN 1. SOURCE<br/>         2. SOURCE<br/>         3. SOURCE<br/>         4. GATE<br/>         5. DRAIN<br/>         6. DRAIN<br/>         7. DRAIN<br/>         8. DRAIN</p>   |
| <p><b>STYLE 13:</b><br/>         PIN 1. N.C.<br/>         2. SOURCE<br/>         3. SOURCE<br/>         4. GATE<br/>         5. DRAIN<br/>         6. DRAIN<br/>         7. DRAIN<br/>         8. DRAIN</p>  | <p><b>STYLE 14:</b><br/>         PIN 1. N-SOURCE<br/>         2. N-GATE<br/>         3. P-SOURCE<br/>         4. P-GATE<br/>         5. P-DRAIN<br/>         6. P-DRAIN<br/>         7. N-DRAIN<br/>         8. N-DRAIN</p>   | <p><b>STYLE 15:</b><br/>         PIN 1. ANODE 1<br/>         2. ANODE 1<br/>         3. ANODE 1<br/>         4. ANODE 1<br/>         5. CATHODE, COMMON<br/>         6. CATHODE, COMMON<br/>         7. CATHODE, COMMON<br/>         8. CATHODE, COMMON</p>               | <p><b>STYLE 16:</b><br/>         PIN 1. EMITTER, DIE #1<br/>         2. BASE, DIE #1<br/>         3. EMITTER, DIE #2<br/>         4. BASE, DIE #2<br/>         5. COLLECTOR, DIE #2<br/>         6. COLLECTOR, DIE #2<br/>         7. COLLECTOR, DIE #1<br/>         8. COLLECTOR, DIE #1</p> |
| <p><b>STYLE 17:</b><br/>         PIN 1. VCC<br/>         2. V2OUT<br/>         3. V1OUT<br/>         4. TXE<br/>         5. RXE<br/>         6. VEE<br/>         7. GND<br/>         8. ACC</p>  | <p><b>STYLE 18:</b><br/>         PIN 1. ANODE<br/>         2. ANODE<br/>         3. SOURCE<br/>         4. GATE<br/>         5. DRAIN<br/>         6. DRAIN<br/>         7. CATHODE<br/>         8. CATHODE</p>   | <p><b>STYLE 19:</b><br/>         PIN 1. SOURCE 1<br/>         2. GATE 1<br/>         3. SOURCE 2<br/>         4. GATE 2<br/>         5. DRAIN 2<br/>         6. MIRROR 2<br/>         7. DRAIN 1<br/>         8. MIRROR 1</p>   | <p><b>STYLE 20:</b><br/>         PIN 1. SOURCE (N)<br/>         2. GATE (N)<br/>         3. SOURCE (P)<br/>         4. GATE (P)<br/>         5. DRAIN<br/>         6. DRAIN<br/>         7. DRAIN<br/>         8. DRAIN</p>   |
| <p><b>STYLE 21:</b><br/>         PIN 1. CATHODE 1<br/>         2. CATHODE 2<br/>         3. CATHODE 3<br/>         4. CATHODE 4<br/>         5. CATHODE 5<br/>         6. COMMON ANODE<br/>         7. COMMON ANODE<br/>         8. CATHODE 6</p>  | <p><b>STYLE 22:</b><br/>         PIN 1. I/O LINE 1<br/>         2. COMMON CATHODE/VCC<br/>         3. COMMON CATHODE/VCC<br/>         4. I/O LINE 3<br/>         5. COMMON ANODE/GND<br/>         6. I/O LINE 4<br/>         7. I/O LINE 5<br/>         8. COMMON ANODE/GND</p> | <p><b>STYLE 23:</b><br/>         PIN 1. LINE 1 IN<br/>         2. COMMON ANODE/GND<br/>         3. COMMON ANODE/GND<br/>         4. LINE 2 IN<br/>         5. LINE 2 OUT<br/>         6. COMMON ANODE/GND<br/>         7. COMMON ANODE/GND<br/>         8. LINE 1 OUT</p> | <p><b>STYLE 24:</b><br/>         PIN 1. BASE<br/>         2. EMITTER<br/>         3. COLLECTOR/ANODE<br/>         4. COLLECTOR/ANODE<br/>         5. CATHODE<br/>         6. CATHODE<br/>         7. COLLECTOR/ANODE<br/>         8. COLLECTOR/ANODE</p>                                      |
| <p><b>STYLE 25:</b><br/>         PIN 1. VIN<br/>         2. N/C<br/>         3. REXT<br/>         4. GND<br/>         5. IOUT<br/>         6. IOUT<br/>         7. IOUT<br/>         8. IOUT</p>   | <p><b>STYLE 26:</b><br/>         PIN 1. GND<br/>         2. dv/dt<br/>         3. ENABLE<br/>         4. ILIMIT<br/>         5. SOURCE<br/>         6. SOURCE<br/>         7. SOURCE<br/>         8. VCC</p>  | <p><b>STYLE 27:</b><br/>         PIN 1. ILIMIT<br/>         2. OVLO<br/>         3. UVLO<br/>         4. INPUT+<br/>         5. SOURCE<br/>         6. SOURCE<br/>         7. SOURCE<br/>         8. DRAIN</p>  | <p><b>STYLE 28:</b><br/>         PIN 1. SW_TO_GND<br/>         2. DASIC OFF<br/>         3. DASIC_SW_DET<br/>         4. GND<br/>         5. V_MON<br/>         6. VBULK<br/>         7. VBULK<br/>         8. VIN</p>  |
| <p><b>STYLE 29:</b><br/>         PIN 1. BASE, DIE #1<br/>         2. EMITTER, #1<br/>         3. BASE, #2<br/>         4. EMITTER, #2<br/>         5. COLLECTOR, #2<br/>         6. COLLECTOR, #2<br/>         7. COLLECTOR, #1<br/>         8. COLLECTOR, #1</p>                        | <p><b>STYLE 30:</b><br/>         PIN 1. DRAIN 1<br/>         2. DRAIN 1<br/>         3. GATE 2<br/>         4. SOURCE 2<br/>         5. SOURCE 1/DRAIN 2<br/>         6. SOURCE 1/DRAIN 2<br/>         7. SOURCE 1/DRAIN 2<br/>         8. GATE 1</p>                           |   |   |

<b>DOCUMENT NUMBER:</b>	<b>98ASB42564B</b>	Electronic versions are uncontrolled except when accessed directly from the Document Repository. Printed versions are uncontrolled except when stamped "CONTROLLED COPY" in red.
<b>DESCRIPTION:</b>	<b>SOIC-8 NB</b>	<b>PAGE 2 OF 2</b>

**onsemi** and **ONSEMI** are trademarks of Semiconductor Components Industries, LLC dba **onsemi** or its subsidiaries in the United States and/or other countries. **onsemi** reserves the right to make changes without further notice to any products herein. **onsemi** makes no warranty, representation or guarantee regarding the suitability of its products for any particular purpose, nor does **onsemi** assume any liability arising out of the application or use of any product or circuit, and specifically disclaims any and all liability, including without limitation special, consequential or incidental damages. **onsemi** does not convey any license under its patent rights nor the rights of others.

# MECHANICAL CASE OUTLINE PACKAGE DIMENSIONS



SCALE 1:1

SOIC-14 NB  
CASE 751A-03  
ISSUE L

DATE 03 FEB 2016



- NOTES:
1. DIMENSIONING AND TOLERANCING PER ASME Y14.5M, 1994.
  2. CONTROLLING DIMENSION: MILLIMETERS.
  3. DIMENSION b DOES NOT INCLUDE DAMBAR PROTRUSION. ALLOWABLE PROTRUSION SHALL BE 0.13 TOTAL IN EXCESS OF AT MAXIMUM MATERIAL CONDITION.
  4. DIMENSIONS D AND E DO NOT INCLUDE MOLD PROTRUSIONS.
  5. MAXIMUM MOLD PROTRUSION 0.15 PER SIDE.

DIM	MILLIMETERS		INCHES	
	MIN	MAX	MIN	MAX
A	1.35	1.75	0.054	0.068
A1	0.10	0.25	0.004	0.010
A3	0.19	0.25	0.008	0.010
b	0.35	0.49	0.014	0.019
D	8.55	8.75	0.337	0.344
E	3.80	4.00	0.150	0.157
e	1.27 BSC		0.050 BSC	
H	5.80	6.20	0.228	0.244
h	0.25	0.50	0.010	0.019
L	0.40	1.25	0.016	0.049
M	0°	7°	0°	7°

### SOLDERING FOOTPRINT\*

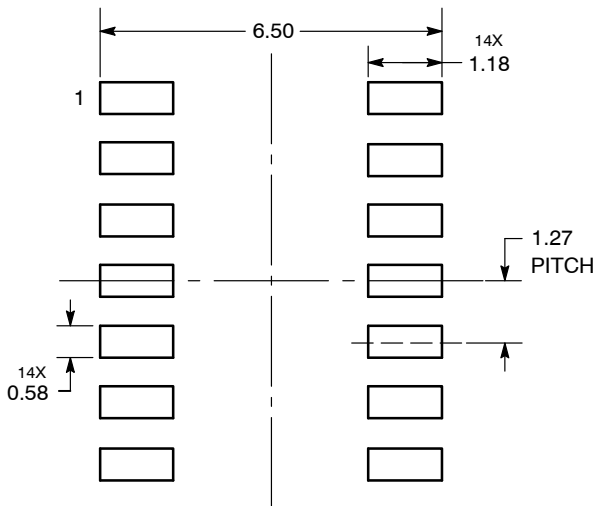

DIMENSIONS: MILLIMETERS

\*For additional information on our Pb-Free strategy and soldering details, please download the ON Semiconductor Soldering and Mounting Techniques Reference Manual, SOLDERRM/D.

### GENERIC MARKING DIAGRAM\*



- XXXXXX = Specific Device Code
- A = Assembly Location
- WL = Wafer Lot
- Y = Year
- WW = Work Week
- G = Pb-Free Package

\*This information is generic. Please refer to device data sheet for actual part marking. Pb-Free indicator, "G" or microdot "▪", may or may not be present. Some products may not follow the Generic Marking.

STYLES ON PAGE 2

DOCUMENT NUMBER:	98ASB42565B	Electronic versions are uncontrolled except when accessed directly from the Document Repository. Printed versions are uncontrolled except when stamped "CONTROLLED COPY" in red.
DESCRIPTION:	SOIC-14 NB	PAGE 1 OF 2

onsemi and ONsemi are trademarks of Semiconductor Components Industries, LLC dba onsemi or its subsidiaries in the United States and/or other countries. onsemi reserves the right to make changes without further notice to any products herein. onsemi makes no warranty, representation or guarantee regarding the suitability of its products for any particular purpose, nor does onsemi assume any liability arising out of the application or use of any product or circuit, and specifically disclaims any and all liability, including without limitation special, consequential or incidental damages. onsemi does not convey any license under its patent rights nor the rights of others.

**SOIC-14**  
**CASE 751A-03**  
**ISSUE L**

DATE 03 FEB 2016

STYLE 1:  
 PIN 1. COMMON CATHODE  
 2. ANODE/CATHODE  
 3. ANODE/CATHODE  
 4. NO CONNECTION  
 5. ANODE/CATHODE  
 6. NO CONNECTION  
 7. ANODE/CATHODE  
 8. ANODE/CATHODE  
 9. ANODE/CATHODE  
 10. NO CONNECTION  
 11. ANODE/CATHODE  
 12. ANODE/CATHODE  
 13. NO CONNECTION  
 14. COMMON ANODE

STYLE 2:  
 CANCELLED

STYLE 3:  
 PIN 1. NO CONNECTION  
 2. ANODE  
 3. ANODE  
 4. NO CONNECTION  
 5. ANODE  
 6. NO CONNECTION  
 7. ANODE  
 8. ANODE  
 9. ANODE  
 10. NO CONNECTION  
 11. ANODE  
 12. ANODE  
 13. NO CONNECTION  
 14. COMMON CATHODE

STYLE 4:  
 PIN 1. NO CONNECTION  
 2. CATHODE  
 3. CATHODE  
 4. NO CONNECTION  
 5. CATHODE  
 6. NO CONNECTION  
 7. CATHODE  
 8. CATHODE  
 9. CATHODE  
 10. NO CONNECTION  
 11. CATHODE  
 12. CATHODE  
 13. NO CONNECTION  
 14. COMMON ANODE

STYLE 5:  
 PIN 1. COMMON CATHODE  
 2. ANODE/CATHODE  
 3. ANODE/CATHODE  
 4. ANODE/CATHODE  
 5. ANODE/CATHODE  
 6. NO CONNECTION  
 7. COMMON ANODE  
 8. COMMON CATHODE  
 9. ANODE/CATHODE  
 10. ANODE/CATHODE  
 11. ANODE/CATHODE  
 12. ANODE/CATHODE  
 13. NO CONNECTION  
 14. COMMON ANODE

STYLE 6:  
 PIN 1. CATHODE  
 2. CATHODE  
 3. CATHODE  
 4. CATHODE  
 5. CATHODE  
 6. CATHODE  
 7. CATHODE  
 8. ANODE  
 9. ANODE  
 10. ANODE  
 11. ANODE  
 12. ANODE  
 13. ANODE  
 14. ANODE

STYLE 7:  
 PIN 1. ANODE/CATHODE  
 2. COMMON ANODE  
 3. COMMON CATHODE  
 4. ANODE/CATHODE  
 5. ANODE/CATHODE  
 6. ANODE/CATHODE  
 7. ANODE/CATHODE  
 8. ANODE/CATHODE  
 9. ANODE/CATHODE  
 10. ANODE/CATHODE  
 11. COMMON CATHODE  
 12. COMMON ANODE  
 13. ANODE/CATHODE  
 14. ANODE/CATHODE

STYLE 8:  
 PIN 1. COMMON CATHODE  
 2. ANODE/CATHODE  
 3. ANODE/CATHODE  
 4. NO CONNECTION  
 5. ANODE/CATHODE  
 6. ANODE/CATHODE  
 7. COMMON ANODE  
 8. COMMON ANODE  
 9. ANODE/CATHODE  
 10. ANODE/CATHODE  
 11. NO CONNECTION  
 12. ANODE/CATHODE  
 13. ANODE/CATHODE  
 14. COMMON CATHODE

<b>DOCUMENT NUMBER:</b>	<b>98ASB42565B</b>	Electronic versions are uncontrolled except when accessed directly from the Document Repository. Printed versions are uncontrolled except when stamped "CONTROLLED COPY" in red.
<b>DESCRIPTION:</b>	<b>SOIC-14 NB</b>	<b>PAGE 2 OF 2</b>

**onsemi** and **ONSEMI** are trademarks of Semiconductor Components Industries, LLC dba **onsemi** or its subsidiaries in the United States and/or other countries. **onsemi** reserves the right to make changes without further notice to any products herein. **onsemi** makes no warranty, representation or guarantee regarding the suitability of its products for any particular purpose, nor does **onsemi** assume any liability arising out of the application or use of any product or circuit, and specifically disclaims any and all liability, including without limitation special, consequential or incidental damages. **onsemi** does not convey any license under its patent rights nor the rights of others.

# MECHANICAL CASE OUTLINE

## PACKAGE DIMENSIONS

ON Semiconductor®



SCALE 2:1

### Micro8 CASE 846A-02 ISSUE K

DATE 16 JUL 2020



TOP VIEW

NOTE 3



SIDE VIEW



END VIEW

**NOTES:**

1. DIMENSIONING AND TOLERANCING PER ASME Y14.5M, 2009.
2. CONTROLLING DIMENSION: MILLIMETERS
3. DIMENSION *b* DOES NOT INCLUDE DAMBAR PROTRUSION. ALLOWABLE PROTRUSION SHALL BE 0.10 mm IN EXCESS OF MAXIMUM MATERIAL CONDITION.
4. DIMENSIONS *D* AND *E* DO NOT INCLUDE MOLD FLASH, PROTRUSION OR GATE BURRS. MOLD FLASH, PROTRUSIONS, OR GATE BURRS SHALL NOT EXCEED 0.15 mm PER SIDE. DIMENSION *E* DOES NOT INCLUDE INTERLEAD FLASH OR PROTRUSION. INTERLEAD FLASH OR PROTRUSION SHALL NOT EXCEED 0.25 mm PER SIDE. DIMENSIONS *D* AND *E* ARE DETERMINED AT DATUM *F*.
5. DATUMS *A* AND *B* ARE TO BE DETERMINED AT DATUM *F*.
6. *A1* IS DEFINED AS THE VERTICAL DISTANCE FROM THE SEATING PLANE TO THE LOWEST POINT ON THE PACKAGE BODY.

⌀ 0.08 (0.003) M C B S A S

DIM	MILLIMETERS		
	MIN.	NOM.	MAX.
A	---	---	1.10
A1	0.05	0.08	0.15
<i>b</i>	0.25	0.33	0.40
<i>c</i>	0.13	0.18	0.23
<i>D</i>	2.90	3.00	3.10
<i>E</i>	2.90	3.00	3.10
<i>e</i>	0.65 BSC		
<i>H<sub>E</sub></i>	4.75	4.90	5.05
<i>L</i>	0.40	0.55	0.70



RECOMMENDED MOUNTING FOOTPRINT

For additional information on our Pb-Free strategy and soldering details, please download the ON Semiconductor Soldering and Mounting Techniques Reference Manual, SOLDERM/D.

### GENERIC MARKING DIAGRAM\*

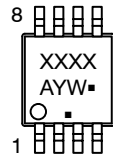

- XXXX = Specific Device Code
- A = Assembly Location
- Y = Year
- W = Work Week
- = Pb-Free Package

(Note: Microdot may be in either location)

\*This information is generic. Please refer to device data sheet for actual part marking. Pb-Free indicator, "G" or microdot "▪", may or may not be present. Some products may not follow the Generic Marking.

**STYLE 1:**

1. SOURCE
2. SOURCE
3. SOURCE
4. GATE
5. DRAIN
6. DRAIN
7. DRAIN
8. DRAIN

**STYLE 2:**

1. SOURCE 1
2. GATE 1
3. SOURCE 2
4. GATE 2
5. DRAIN 2
6. DRAIN 2
7. DRAIN 1
8. DRAIN 1

**STYLE 3:**

1. N-SOURCE
2. N-GATE
3. P-SOURCE
4. P-GATE
5. P-DRAIN
6. P-DRAIN
7. N-DRAIN
8. N-DRAIN

<b>DOCUMENT NUMBER:</b>	<b>98ASB14087C</b>	Electronic versions are uncontrolled except when accessed directly from the Document Repository. Printed versions are uncontrolled except when stamped "CONTROLLED COPY" in red.
<b>DESCRIPTION:</b>	<b>MICRO8</b>	<b>PAGE 1 OF 1</b>

ON Semiconductor and ON are trademarks of Semiconductor Components Industries, LLC dba ON Semiconductor or its subsidiaries in the United States and/or other countries. ON Semiconductor reserves the right to make changes without further notice to any products herein. ON Semiconductor makes no warranty, representation or guarantee regarding the suitability of its products for any particular purpose, nor does ON Semiconductor assume any liability arising out of the application or use of any product or circuit, and specifically disclaims any and all liability, including without limitation special, consequential or incidental damages. ON Semiconductor does not convey any license under its patent rights nor the rights of others.

# MECHANICAL CASE OUTLINE PACKAGE DIMENSIONS



TSSOP-14 WB  
CASE 948G  
ISSUE C

DATE 17 FEB 2016

SCALE 2:1



NOTES:

- DIMENSIONING AND TOLERANCING PER ANSI Y14.5M, 1982.
- CONTROLLING DIMENSION: MILLIMETER.
- DIMENSION A DOES NOT INCLUDE MOLD FLASH, PROTRUSIONS OR GATE BURRS. MOLD FLASH OR GATE BURRS SHALL NOT EXCEED 0.15 (0.006) PER SIDE.
- DIMENSION B DOES NOT INCLUDE INTERLEAD FLASH OR PROTRUSION. INTERLEAD FLASH OR PROTRUSION SHALL NOT EXCEED 0.25 (0.010) PER SIDE.
- DIMENSION K DOES NOT INCLUDE DAMBAR PROTRUSION. ALLOWABLE DAMBAR PROTRUSION SHALL BE 0.08 (0.003) TOTAL IN EXCESS OF THE K DIMENSION AT MAXIMUM MATERIAL CONDITION.
- TERMINAL NUMBERS ARE SHOWN FOR REFERENCE ONLY.
- DIMENSION A AND B ARE TO BE DETERMINED AT DATUM PLANE -W-.

DIM	MILLIMETERS		INCHES	
	MIN	MAX	MIN	MAX
A	4.90	5.10	0.193	0.200
B	4.30	4.50	0.169	0.177
C	---	1.20	---	0.047
D	0.05	0.15	0.002	0.006
F	0.50	0.75	0.020	0.030
G	0.65 BSC		0.026 BSC	
H	0.50	0.60	0.020	0.024
J	0.09	0.20	0.004	0.008
J1	0.09	0.16	0.004	0.006
K	0.19	0.30	0.007	0.012
K1	0.19	0.25	0.007	0.010
L	6.40 BSC		0.252 BSC	
M	0°	8°	0°	8°

GENERIC MARKING DIAGRAM\*

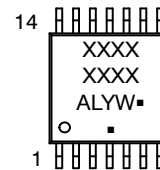

- A = Assembly Location
- L = Wafer Lot
- Y = Year
- W = Work Week
- = Pb-Free Package

(Note: Microdot may be in either location)

\*This information is generic. Please refer to device data sheet for actual part marking. Pb-Free indicator, "G" or microdot "▪", may or may not be present. Some products may not follow the Generic Marking.

SOLDERING FOOTPRINT



DOCUMENT NUMBER:	98ASH70246A	Electronic versions are uncontrolled except when accessed directly from the Document Repository. Printed versions are uncontrolled except when stamped "CONTROLLED COPY" in red.
DESCRIPTION:	TSSOP-14 WB	PAGE 1 OF 1

onsemi and onsemi are trademarks of Semiconductor Components Industries, LLC dba onsemi or its subsidiaries in the United States and/or other countries. onsemi reserves the right to make changes without further notice to any products herein. onsemi makes no warranty, representation or guarantee regarding the suitability of its products for any particular purpose, nor does onsemi assume any liability arising out of the application or use of any product or circuit, and specifically disclaims any and all liability, including without limitation special, consequential or incidental damages. onsemi does not convey any license under its patent rights nor the rights of others.



**onsemi**, **Onsemi**, and other names, marks, and brands are registered and/or common law trademarks of Semiconductor Components Industries, LLC dba "**onsemi**" or its affiliates and/or subsidiaries in the United States and/or other countries. **onsemi** owns the rights to a number of patents, trademarks, copyrights, trade secrets, and other intellectual property. A listing of **onsemi**'s product/patent coverage may be accessed at [www.onsemi.com/site/pdf/Patent-Marking.pdf](http://www.onsemi.com/site/pdf/Patent-Marking.pdf). **onsemi** reserves the right to make changes at any time to any products or information herein, without notice. The information herein is provided "as-is" and **onsemi** makes no warranty, representation or guarantee regarding the accuracy of the information, product features, availability, functionality, or suitability of its products for any particular purpose, nor does **onsemi** assume any liability arising out of the application or use of any product or circuit, and specifically disclaims any and all liability, including without limitation special, consequential or incidental damages. Buyer is responsible for its products and applications using **onsemi** products, including compliance with all laws, regulations and safety requirements or standards, regardless of any support or applications information provided by **onsemi**. "Typical" parameters which may be provided in **onsemi** data sheets and/or specifications can and do vary in different applications and actual performance may vary over time. All operating parameters, including "Typicals" must be validated for each customer application by customer's technical experts. **onsemi** does not convey any license under any of its intellectual property rights nor the rights of others. **onsemi** products are not designed, intended, or authorized for use as a critical component in life support systems or any FDA Class 3 medical devices or medical devices with a same or similar classification in a foreign jurisdiction or any devices intended for implantation in the human body. Should Buyer purchase or use **onsemi** products for any such unintended or unauthorized application, Buyer shall indemnify and hold **onsemi** and its officers, employees, subsidiaries, affiliates, and distributors harmless against all claims, costs, damages, and expenses, and reasonable attorney fees arising out of, directly or indirectly, any claim of personal injury or death associated with such unintended or unauthorized use, even if such claim alleges that **onsemi** was negligent regarding the design or manufacture of the part. **onsemi** is an Equal Opportunity/Affirmative Action Employer. This literature is subject to all applicable copyright laws and is not for resale in any manner.

## ADDITIONAL INFORMATION

### TECHNICAL PUBLICATIONS:

Technical Library: [www.onsemi.com/design/resources/technical-documentation](http://www.onsemi.com/design/resources/technical-documentation)  
onsemi Website: [www.onsemi.com](http://www.onsemi.com)

### ONLINE SUPPORT: [www.onsemi.com/support](http://www.onsemi.com/support)

For additional information, please contact your local Sales Representative at [www.onsemi.com/support/sales](http://www.onsemi.com/support/sales)

