

AQ Series • High Accuracy - High Current - High O/P Voltage Current Transformers

Features

- High Accuracy, High Current, High Output Voltage Current Transformers
- 0.1-0.2% Accuracy Typical
- Excellent Linearity over rated current range
- 2.5kV Isolation
- Frequency 50-60Hz
- All materials UL94V-0
- Manufactured in an ISO 9001:2015 and ISO 14001:2015 certified Talema facility
- Fully RoHS & REACH Compliant



Applications:

- Instrumentation
- Energy Meters
- EV Charging

Electrical Specifications at 20°C

Part Number	Rated Current (Amps)	Turns	Burden Resistance (Ohms)	Output Voltage (Volts)	Max. Current (Amps)	DCR (Ohms)	Mounting
AQ-1020-FL	20	1000	15	0.30	40	78	Flying Leads
AQ-1020	20	1000	15	0.30	40	24	PCB
AQ-2532	32	2500	25	0.32	50	130	PCB
AQ-2563	63	2500	33	0.83	75	85	PCB
AQ-25125	125	2500	50	2.50	150	95	PCB

Mechanical Drawing

AQ-1020-FL

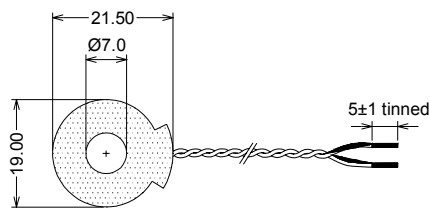

TOP VIEW

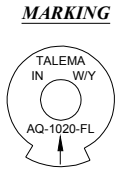

MARKING

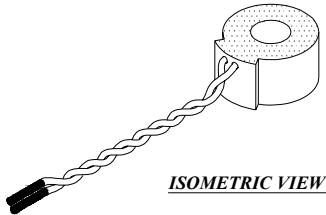

ISOMETRIC VIEW



Leadouts: Flex UL1569 AWG24, 300V Rating, 250±5mm long out of trafo with 5±1mm tinned ends

Dimensional Unit : mm
Dimensional Tolerance: ±0.25mm (unless specified)

Mechanical Drawing

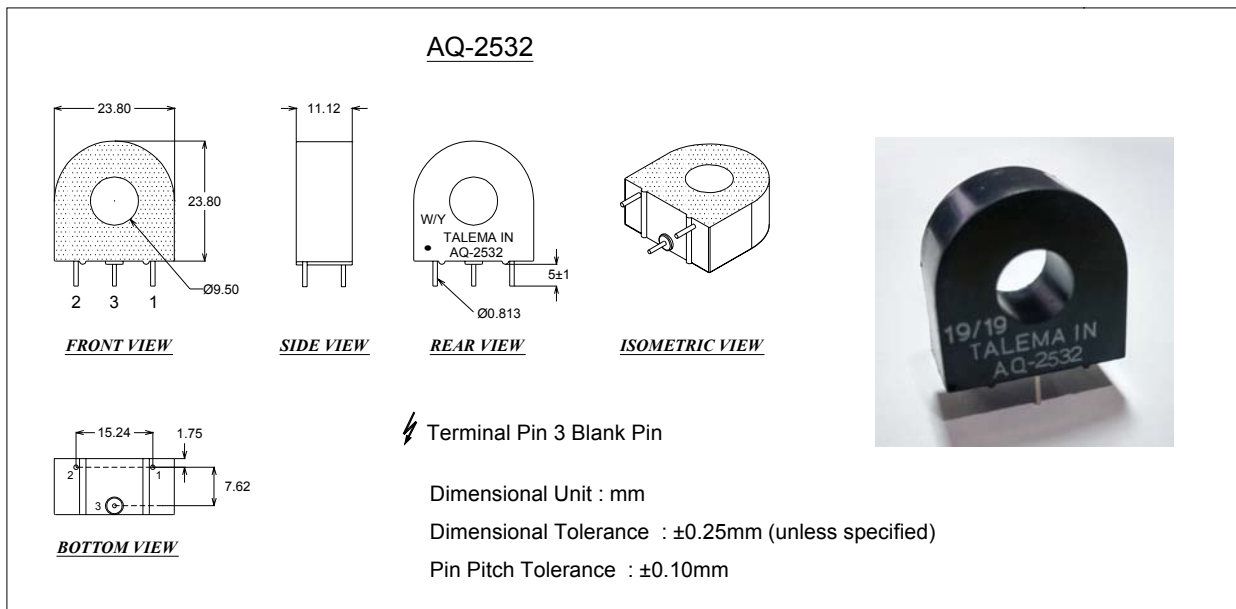
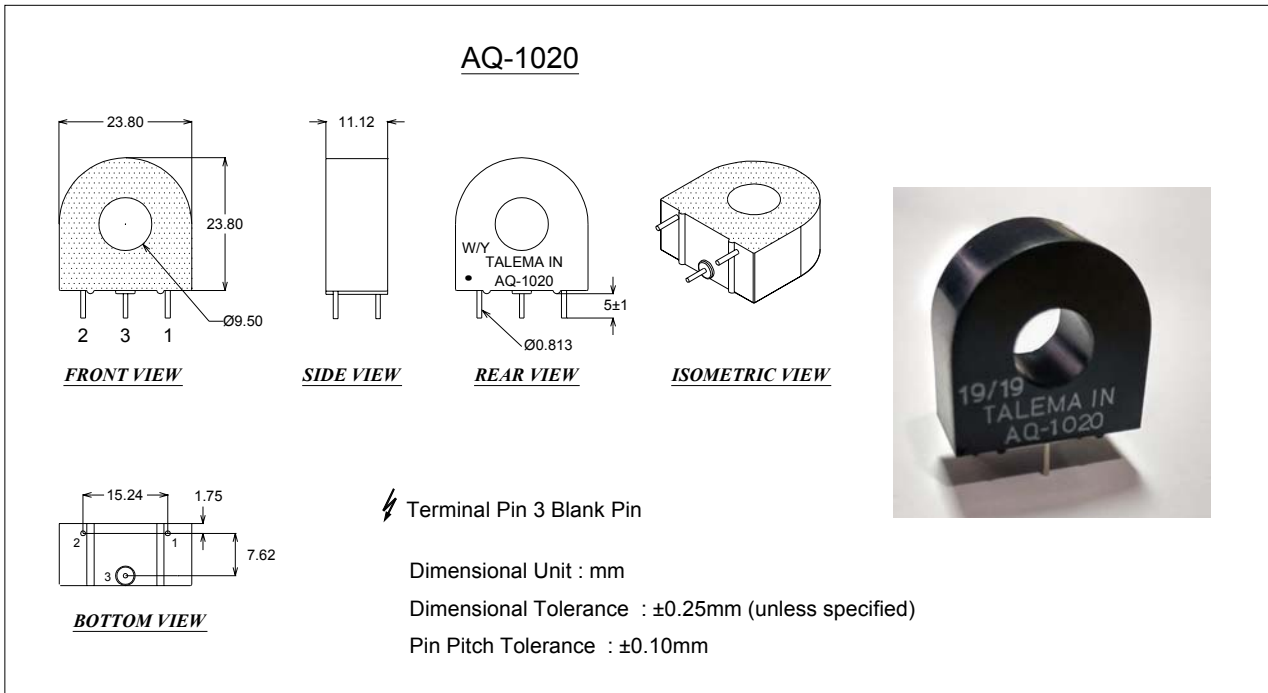

Mechanical Drawing

AQ-2563

FRONT VIEW **SIDE VIEW** **BACK VIEW** **ISOMETRIC VIEW**

Terminal Pins 4x0.8mm

Terminal Pins 3 & 4 Blank Pins

Dimensional Unit : mm
 Dimensional Tolerance : ±0.25mm (unless specified)
 Pin Pitch Tolerance : ±0.10mm

AQ-25125

FRONT VIEW **SIDE VIEW** **BACK VIEW** **ISOMETRIC VIEW**

Terminal Pins 4x0.8mm

Terminal Pins 3 & 4 Blank Pins

Dimensional Unit : mm
 Dimensional Tolerance : ±0.25mm (unless specified)
 Pin Pitch Tolerance : ±0.10mm

Output Response at Rated Burden

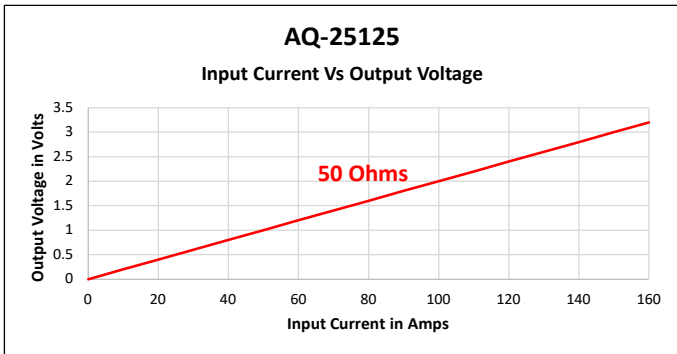
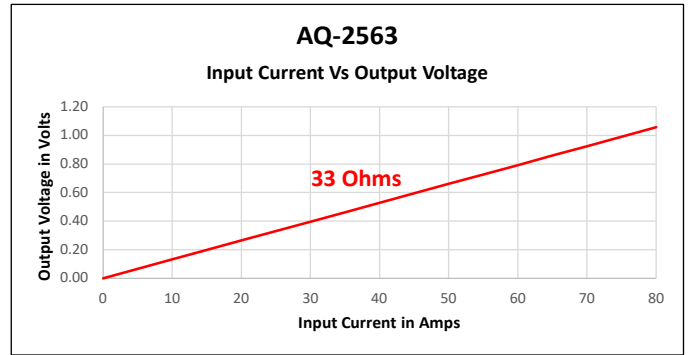
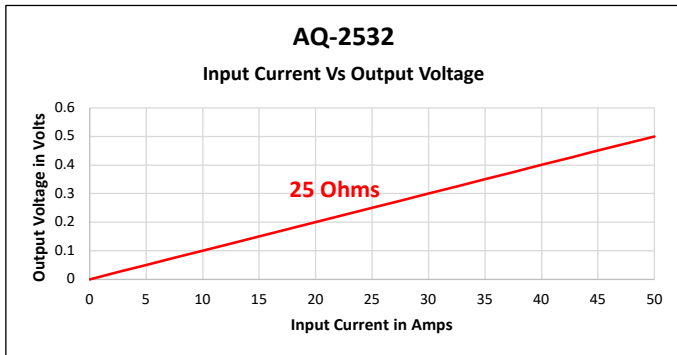
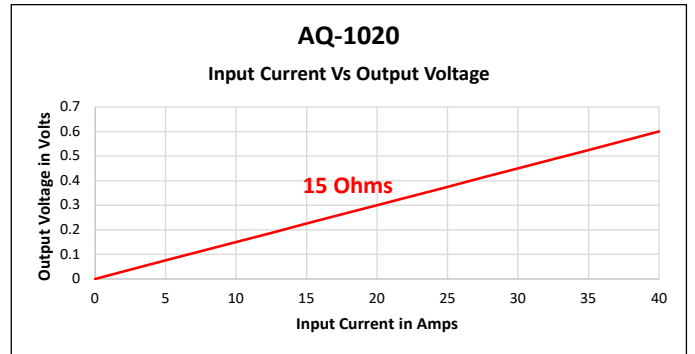
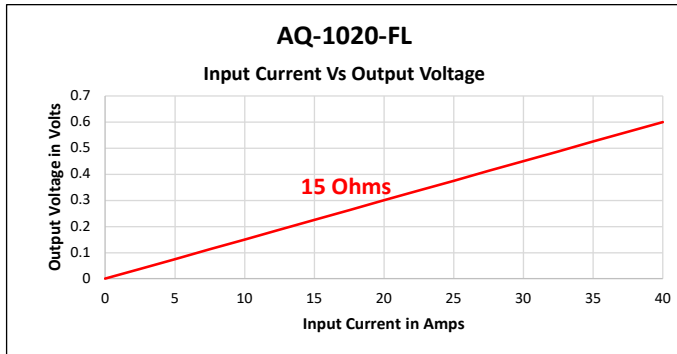

Regional Locations - Design, Manufacturing, Sales & Marketing
Talema Group Regional Offices
North America
**United States
(Sales & Marketing)**

Talema Group, LLC
 PO Box 935
 900 Innovation Drive
 Suite 120, Rolla
 Missouri 65402
 Tel: +1 573-303-3675
 E-Mail:
sales@talema.com
 Web: talema.com

Asia
**India
(Design, Manufacturing, Sales & Marketing)**

Administrative Office
Talema Electronic India Private Limited
 Door No. 221, 1st and 2nd Floor
 KJ Plaza, Opp.to Vidya Mandir School
 Meyanoor Main Road
 Salem - 636 004 Tamil Nadu INDIA
 Tel: +91 427 - 243 3100
 Fax: +91 427 - 243 3109
 E-Mail: talema@talemaindia.net
 Web: talema.com

Factory Premises
Talema Electronic India Private Limited
 Plot Nos. 30, 31 Electrical and Electronic
 Industrial Estate
 Suramangalam
 Salem - 636 005 Tamil Nadu INDIA
 Tel: +91 427 - 243 3000
 E-Mail: talema@talemaindia.net
 Web: talema.com

Europe
**Germany
(Design, Sales & Marketing)**

Talema Elektronik GmbH
 Sembdnerstr. 5
 82110 Germering
 Tel: +49 89 - 841 00 - 0
 Fax: +49 89 - 841 00 25
 E-Mail: info@talema.de
 Web: talema.com

**Ireland
(Design, Sales & Marketing)**

Nuvotem TEO
 Units W & X, Gweedore Business Park
 Derrybeg, Letterkenny, Co. Donegal
 Tel: +353 (0) 74 95 48666
 Fax: +353 (0) 74 95 48139
 E-Mail: info@nuvotem.com
 Web: talema.com

**Czech Republic
(Design, Manufacturing, Sales & Marketing)**

NT Magnetics s.r.o.
 Chebská 27
 322 00 Plzeň
 Tel: +420 377 - 338 351
 Fax: +420 377 - 338 350
 E-Mail: talema@talema.cz
 Web: talema.com

Locations of Talema Group Regional Offices
