

# EFR32MG12 2.4 GHz 10 dBm Radio Board BRD4162A Reference Manual



The BRD4162A Mighty Gecko Radio Board enables developers to develop Zigbee®, Thread, *Bluetooth*® low energy and proprietary wireless applications. The board contains a Mighty Gecko Wireless System on Chip 2.4 GHz and optimized for operation with 10 dBm output power. With the on-board printed antenna and RF connector radiated and conducted testing is supported.

The BRD4162A Mighty Gecko Radio Board plugs into the Wireless Starter Kit Main-board provided with the Mighty Gecko Starter Kit to get access to display, buttons and additional features from Expansion Boards. With the supporting Simplicity Studio suite of tools, developers can take advantage of graphical wireless application development; mesh networking debug and packet trace; and visual energy profiling and optimization. The board also serves as an RF reference design for applications targeting 2.4 GHz wireless operation with 10 dBm output power.

This document contains brief introduction and description of the BRD4162A Radio Board features focusing on the RF sections and performance.

## RADIO BOARD FEATURES

- Wireless SoC: EFR32MG12P332F1024GL125
- CPU core: ARM Cortex®-M4 with FPU
- Flash memory: 1024 kB
- RAM: 256 kB
- Operation frequency: 2.4 GHz
- Transmit power: 10 dBm
- Integrated PCB antenna, UFL connector (optional).
- Touch Slider
- Crystals for LFXO and HFXO: 32.768 kHz and 38.4 MHz.

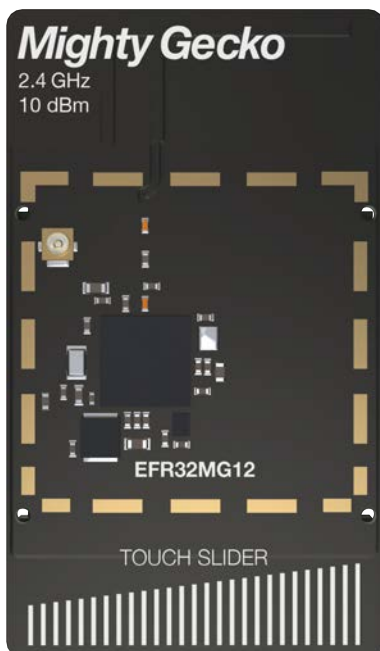

## 1. Introduction

The EFR32 Mighty Gecko Radio Boards provide a development platform (together with the Wireless Starter Kit Mainboard) for the Silicon Labs EFR32 Mighty Gecko Wireless System on Chips and serve as reference designs for the matching network of the RF interface.

The BRD4162A Radio Board is designed to operate in the 2400-2483.5 MHz band with the RF matching network optimized to operate with 10 dBm output power.

To develop and/or evaluate the EFR32 Mighty Gecko, the BRD4162A Radio Board can be connected to the Wireless Starter Kit Mainboard to get access to display, buttons and additional features from Expansion Boards and also to evaluate the performance of the RF interface.

## 2. Radio Board Connector

### 2.1 Introduction

The board-to-board connector scheme allows access to all EFR32MG12 GPIO pins as well as the RESETn signal. For more information on the functions of the available pin functions, see the EFR32MG12 data sheet.

### 2.2 Radio Board Connector Pin Associations

The figure below shows the pin mapping on the connector to the radio pins and their function on the Wireless Starter Kit Mainboard.

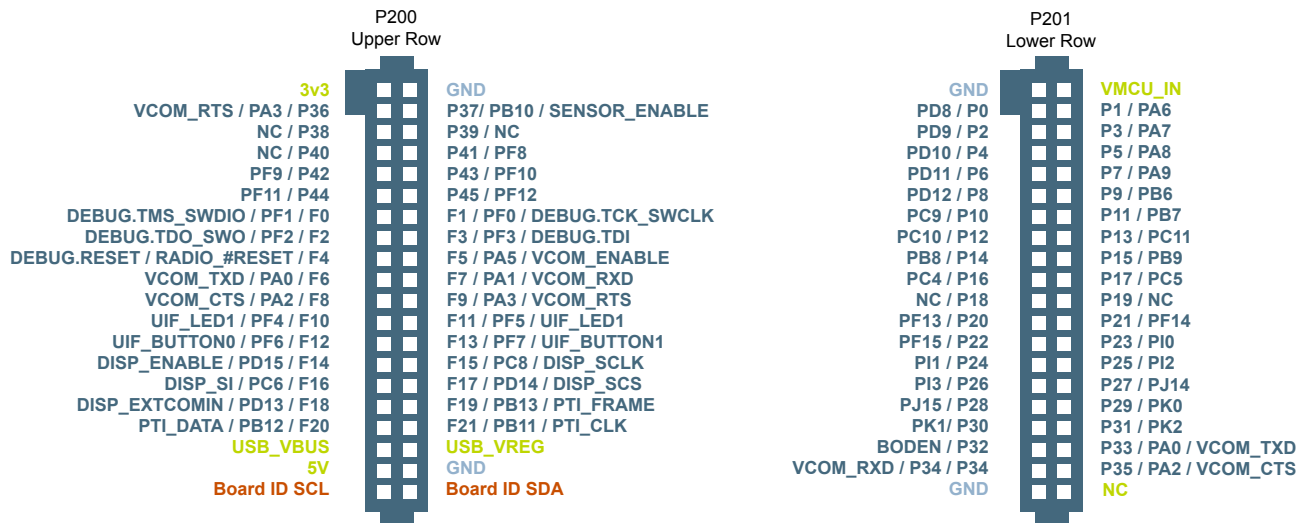

Figure 2.1. BRD4162A Radio Board Connector Pin Mapping

### 3. Radio Board Block Summary

#### 3.1 Introduction

This section gives a short introduction to the blocks of the BRD4162A Radio Board.

#### 3.2 Radio Board Block Diagram

The block diagram of the EFR32MG Radio Board is shown in the figure below.

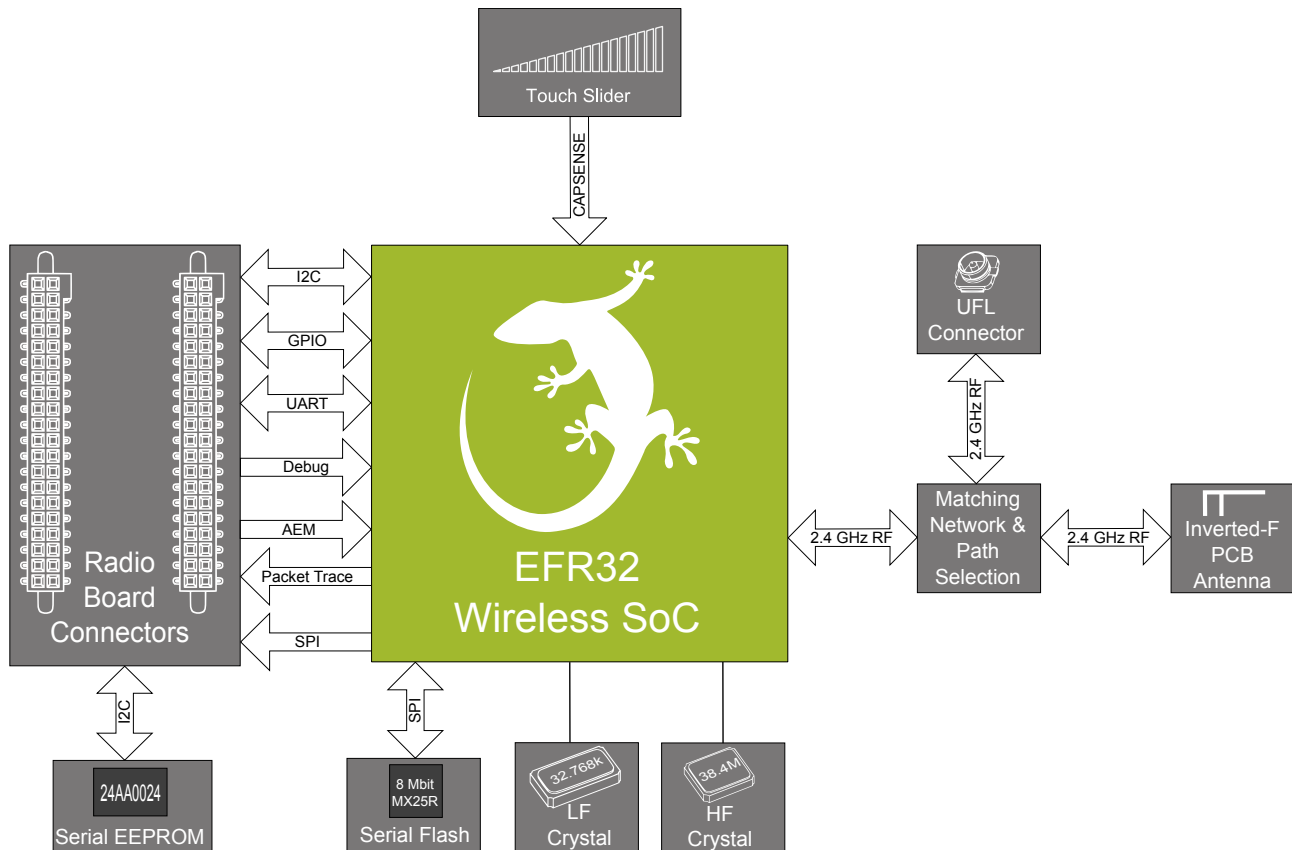

Figure 3.1. BRD4162A Block Diagram

#### 3.3 Radio Board Block Description

##### 3.3.1 Wireless MCU

The BRD4162A Mighty Gecko Radio Board incorporates an EFR32MG12P332F1024GL125 Wireless System on Chip featuring 32-bit Cortex<sup>®</sup>-M4 with FPU core, 1024 kB of flash memory and 256 kB of RAM and a 2.4 GHz band transceiver with output power up to 10 dBm. For additional information on the EFR32MG12P332F1024GL125, refer to the EFR32MG12 Data Sheet.

##### 3.3.2 LF Crystal Oscillator (LFXO)

The BRD4162A Radio Board has a 32.768 kHz crystal mounted.

##### 3.3.3 HF Crystal Oscillator (HFXO)

The BRD4162A Radio Board has a 38.4 MHz crystal mounted.

### 3.3.4 Matching Network for 2.4 GHz

The BRD4162A Radio Board incorporates a 2.4 GHz matching network which connects the 2.4 GHz TRX pin of the EFR32MG12 to the one on-board printed Inverted-F antenna. The component values were optimized for the 2.4 GHz band RF performance and current consumption with 10 dBm output power.

For detailed description of the matching network, see Chapter 4.2.1 [Description of the 2.4 GHz RF Matching](#).

### 3.3.5 Inverted-F Antenna

The BRD4162A Radio Board includes a printed Inverted-F antenna (IFA) tuned to have close to 50 Ohm impedance at the 2.4 GHz band.

For detailed description of the antenna see Chapter 4.5 [Inverted-F Antenna](#).

### 3.3.6 UFL Connector

To be able to perform conducted measurements, Silicon Labs added an UFL connector to the Radio Board. The connector allows an external 50 Ohm cable or antenna to be connected during design verification or testing.

**Note:** By default the output of the matching network is connected to the printed Inverted-F antenna by a series component. It can be connected to the UFL connector as well through a series 0 Ohm resistor which is not mounted by default. For conducted measurements through the UFL connector the series component to the antenna should be removed and the 0 Ohm resistor should be mounted (see Chapter 4.2 [Schematic of the RF Matching Network](#) for further details).

### 3.3.7 Radio Board Connectors

Two dual-row, 0.05" pitch polarized connectors make up the EFR32MG Radio Board interface to the Wireless Starter Kit Mainboard.

For more information on the pin mapping between the EFR32MG12P332F1024GL125 and the Radio Board Connector, refer to Chapter 2.2 [Radio Board Connector Pin Associations](#).

### 3.3.8 Capacitive Touch Slider

The touch slider (T2) utilizes the capacitive touch capability of the Capacitance Sense Module of the EFR32MG12. The slider interpolates 4 separate pads to find the exact position of a finger.

The figure below shows the pin mapping of the touch slider to the Wireless SoC.

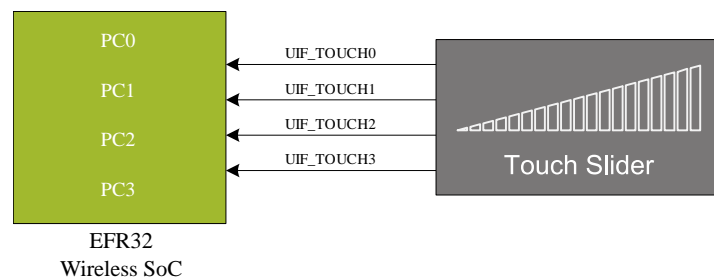

**Figure 3.2. Touch Slider Pin Mapping**

## 4. RF Section

### 4.1 Introduction

This section gives a short introduction to the RF section of the BRD4162A.

### 4.2 Schematic of the RF Matching Network

The schematic of the RF section of the BRD4162A Radio Board is shown in the following figure.

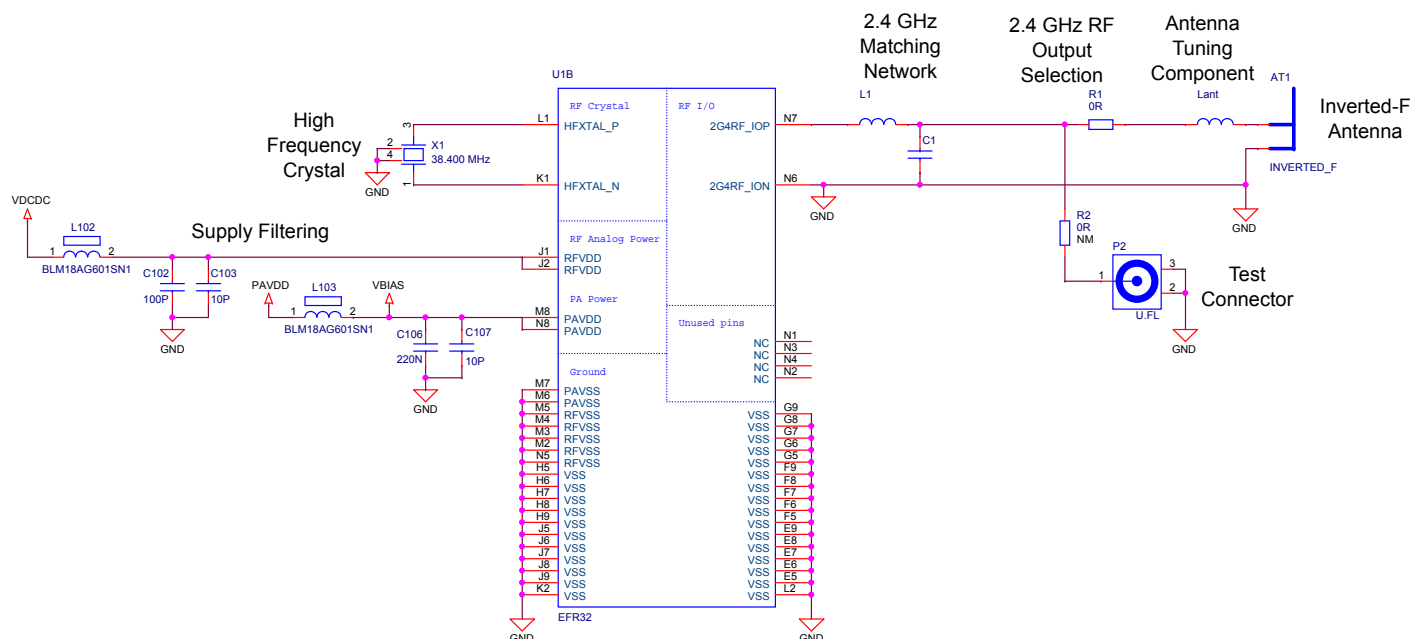

Figure 4.1. Schematic of the RF Section of the BRD4162A

#### 4.2.1 Description of the 2.4 GHz RF Matching

The 2.4 GHz matching connects the 2G4RF\_IOP pin to the on-board printed Inverted-F Antenna. The 2G4RF\_ION pin is connected to ground. For lower output powers (under 13 dBm) additional harmonic filtering is not required as the harmonic levels are below the regulation limits (see Chapter 7.1 Conducted Power Measurements). Therefore, the matching network comprises only a two-element impedance matching circuitry. The targeted output power is 10 dBm.

For for conducted measurements the output of the matching network can also be connected to the UFL connector by removing the series R1 resistor between the antenna and the output of the matching and adding a 0 Ohm resistor to the R2 resistor position between the output of the matching and the UFL connector.

### 4.3 RF Section Power Supply

On the BRD4162A Radio Board the power supply pins of the RF section (RFVDD, PAVDD) are directly connected to the output of the on-chip DC-DC converter. This way, by default, the DC-DC converter provides 1.8 V for the entire RF section (for details, see the schematic of the BRD4162A).

### 4.4 Bill of Materials for the 2.4 GHz Matching

The Bill of Materials of the 2.4 GHz matching network of the BRD4162A Radio Board is shown in the following table.

Table 4.1. Bill of Materials for the BRD4162A 2.4GHz RF Matching Network

Component name	Value	Manufacturer	Part Number
L1	1.9 nH	Murata	LQP15MN1N9W02D
C1	1.5 pF	Murata	GRM1555C1H1R5WA01D

#### 4.5 Inverted-F Antenna

The BRD4162A Radio Board includes an on-board printed Inverted-F Antenna tuned for the 2.4 GHz band. Due to the design restrictions of the Radio Board, the input of the antenna and the output of the matching network can't be placed directly next to each other. As a result, a 50 Ohm transmission line was necessary to connect them. With the actual line length the impedance of the antenna at the double-harmonic frequency is transformed closer to a "critical load impedance range" resulting in the radiated level of the harmonic increases.

To reduce the harmonic radiation a tuning component was used between the matching network output and the antenna input. For the actual Radio Board design (with the actual transmission line length) a small value inductor was used (Lant inductor with value of 1.9 nH) to transform the impedance at the double-frequency harmonic away from the critical region while keeping the impedance at the funamental close to 50 Ohm. With this the suppression of the radiated double-frequency harmonic increases by approximately . The resulting impedance and reflection measured at the output of the matcing network are shown in the following figure. As it can be observed the impedance is close to 50 Ohm (the reflection is better than -10 dB) for the entire 2.4 GHz band.

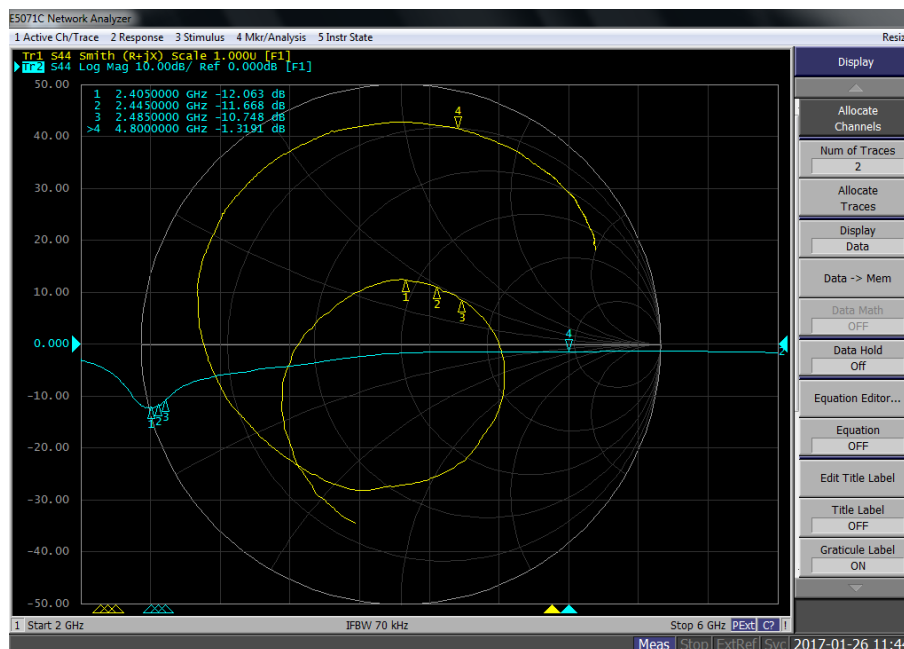

Figure 4.2. Impedance and Reflection of the Inverted-F Antenna of the BRD4162A Board Measured from the Matching Output

**Note:** The suppression of the double-frequency harmonic can be further increased by using a slightly higher inductor value but for the current board the suppression achieved with 1.9 nH is sufficient (see Chapter 7.2 Radiated Power Measurements). Therefore, for BOM cost reduction the same value and type of inductor was used as the one in the matching network (L1).

## 5. Mechanical Details

The BRD4162A Mighty Gecko Radio Board is illustrated in the figures below.

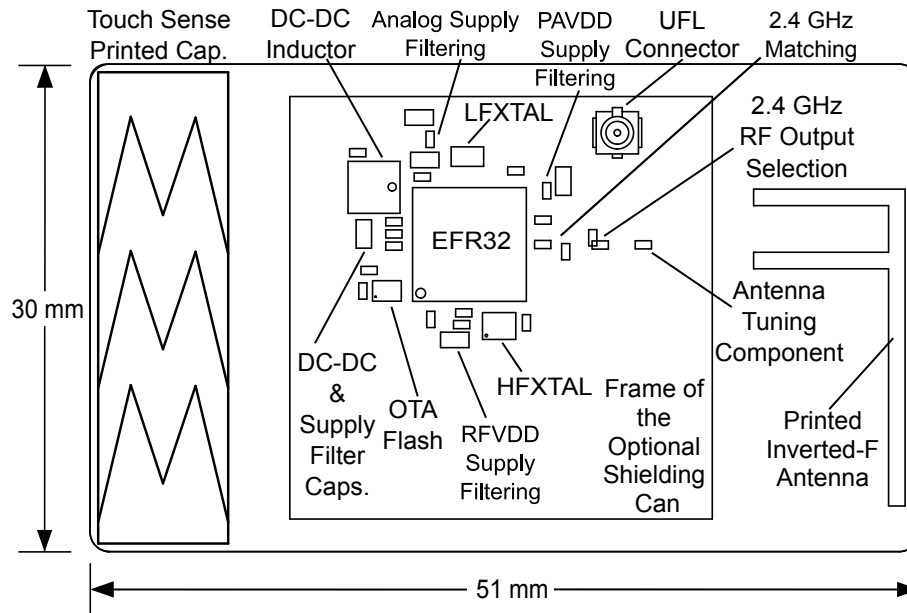

Figure 5.1. BRD4162A Top View

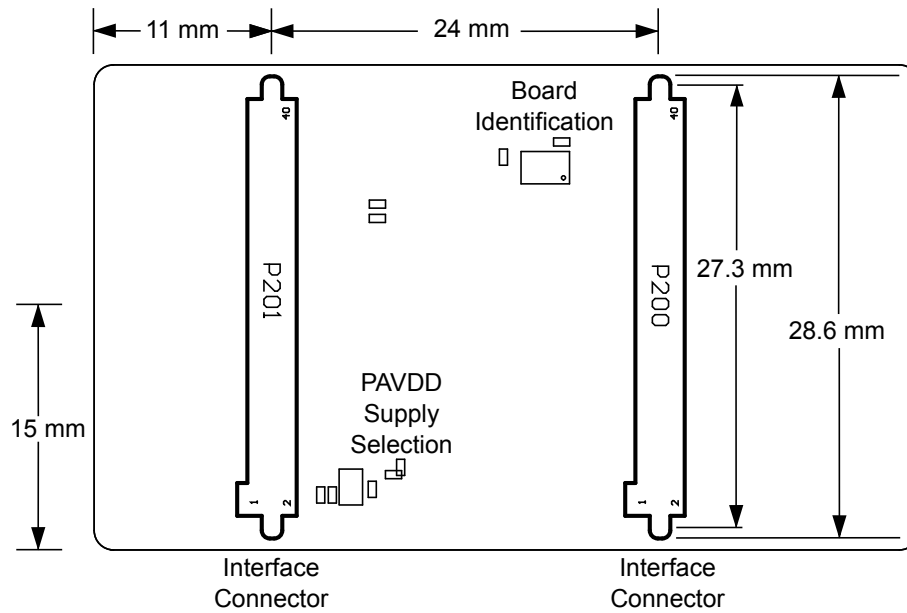

Figure 5.2. BRD4162A Bottom View



## 6. EMC Compliance

### 6.1 Introduction

Compliance of the fundamental and harmonic levels is tested against the following standards:

- 2.4 GHz:
  - ETSI EN 300-328
  - FCC 15.247

### 6.2 EMC Regulations for 2.4 GHz

#### 6.2.1 ETSI EN 300-328 Emission Limits for the 2400-2483.5 MHz Band

Based on ETSI EN 300-328 the allowed maximum fundamental power for the 2400-2483.5 MHz band is 20 dBm EIRP. For the unwanted emissions in the 1 GHz to 12.75 GHz domain the specified limit is -30 dBm EIRP.

#### 6.2.2 FCC15.247 Emission Limits for the 2400-2483.5 MHz Band

FCC 15.247 allows conducted output power up to 1 Watt (30 dBm) in the 2400-2483.5 MHz band. For spurious emissions the limit is -20 dBc based on either conducted or radiated measurement, if the emission is not in a restricted band. The restricted bands are specified in FCC 15.205. In these bands the spurious emission levels must meet the levels set out in FCC 15.209. In the range from 960 MHz to the frequency of the 5th harmonic it is defined as 0.5 mV/m at 3 m distance (equals to -41.2 dBm in EIRP).

Additionally, for spurious frequencies above 1 GHz, FCC 15.35 allows duty-cycle relaxation to the regulatory limits. For the EmberZNet PRO the relaxation is 3.6 dB. Therefore, the -41.2 dBm limit can be modified to -37.6 dBm.

If operating in the 2400-2483.5 MHz band the 2nd, 3rd and 5th harmonics can fall into restricted bands. As a result, for those the -37.6 dBm limit should be applied. For the 4th harmonic the -20 dBc limit should be applied.

#### 6.2.3 Applied Emission Limits for the 2.4 GHz Band

The above ETSI limits are applied both for conducted and radiated measurements.

The FCC restricted band limits are radiated limits only. Besides that, Silicon Labs applies those to the conducted spectrum i.e., it is assumed that, in case of a custom board, an antenna is used which has 0 dB gain at the fundamental and the harmonic frequencies. In that theoretical case, based on the conducted measurement, the compliance with the radiated limits can be estimated.

The overall applied limits are shown in the table below.

**Table 6.1. Applied Limits for Spurious Emissions for the 2.4 GHz Band**

Harmonic	Frequency	Limit
2nd	4800~4967 MHz	-37.6 dBm
3rd	7200~7450.5 MHz	-37.6 dBm
4th	9600~9934 MHz	-30 dBm
5th	12000~12417.5 MHz	-37.6 dBm

## 7. RF Performance

### 7.1 Conducted Power Measurements

During measurements, the EFR32MG Radio Board was attached to a Wireless Starter Kit Mainboard which was supplied by USB. The voltage supply for the Radio Board was 3.3 V.

#### 7.1.1 Conducted Measurements in the 2.4 GHz band

The BRD4162A board was connected directly to a Spectrum Analyzer through its UFL connector (the R1 resistor was removed and a 0 Ohm resistor was soldered to the R2 resistor position). During measurements, the voltage supply for the board was 3.3 V provided by the mainboard. The supply for the RF section was 1.8 V provided by the on-chip DC-DC converter (for details, see the schematic of the BRD4162A). The transceiver was operated in continuous carrier transmission mode. The output power of the radio was set to 10 dBm.

The typical output spectrum is shown in the following figure.

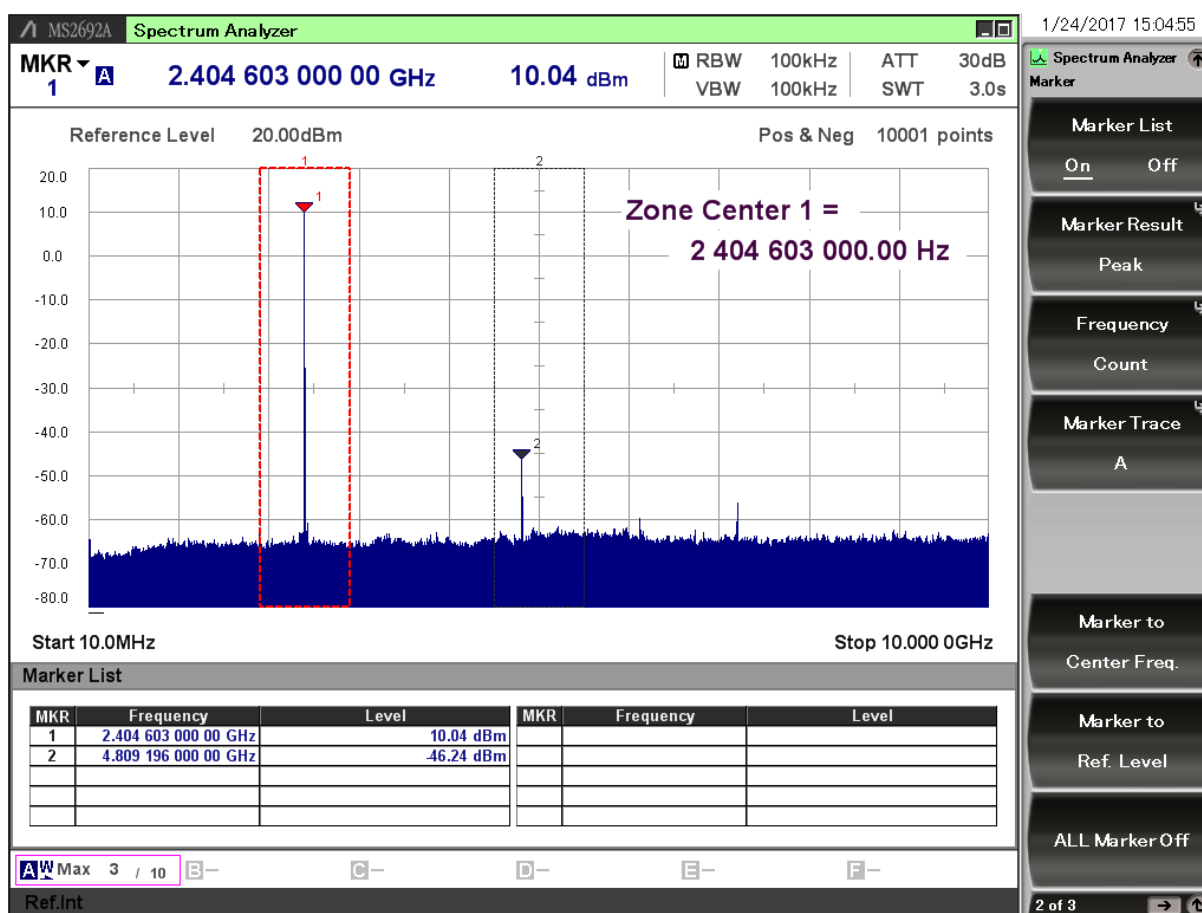

Figure 7.1. Typical Output Spectrum of the BRD4162A

As it can be observed, the fundamental is slightly higher than 10 dBm limit and the strongest unwanted emission is the double-frequency harmonic and it is under the -37.6 dBm applied limit.

**Note:** The conducted measurement is performed by connecting the on-board UFL connector to a Spectrum Analyzer through an SMA Conversion Adapter (P/N: HRMJ-U.FLP(40)). This connection itself introduces approximately 0.3 dB insertion loss.

## 7.2 Radiated Power Measurements

During measurements, the EFR32MG Radio Board was attached to a Wireless Starter Kit Mainboard which was supplied by USB. The voltage supply for the Radio Board was 3.3 V. The radiated power was measured in an antenna chamber by rotating the DUT 360 degrees with horizontal and vertical reference antenna polarizations in the XY, XZ and YZ cuts. The measurement axes are shown in the figure below.



Figure 7.2. DUT: Radio Board with the Wireless Starter Kit Mainboard (Illustration)

**Note:** The radiated measurement results presented in this document were recorded in an unlicensed antenna chamber. Also the radiated power levels may change depending on the actual application (PCB size, used antenna, and so on). Therefore, the absolute levels and margins of the final application are recommended to be verified in a licensed EMC testhouse.

### 7.2.1 Radiated Measurements in the 2.4 GHz band

For the transmitter antenna the on-board printed Inverted-F antenna of the BRD4162A board was used (the R1 resistor was mounted). During measurements, the board was attached to a Wireless Starter Kit Mainboard (BRD4001 (Rev. A02) ) which was supplied through USB. During the measurements the voltage supply for the board was 3.3 V provided by the mainboard. The supply for the RF section was 1.8 V provided by the on-chip DC-DC converter (for details, see the schematic of the BRD4162A). The transceiver was operated in continuous carrier transmission mode. The output power of the radio was set to 10 dBm based on the conducted measurement.

The results are shown in the table below.

Table 7.1. Maximums of the measured radiated powers in EIRP [dBm]

Frequency	EIRP [dBm]	Orientation	Margin [dB]	Limit in EIRP [dBm]
Fund	12.5	YZ/V	17.5	30
2nd	-51.7	YZ/H	14.1	-37.6
3rd	<-50*	-/-	>10	-37.6
4th	<-50*	-/-	>10	-30
5th	<-50*	-/-	>10	-37.6

\* Signal level is below the Spectrum Analyzer noise floor.

As it can be observed, thanks to the high gain of the Inverted-F antenna, the level of the fundamental is higher than 10 dBm. The strongest harmonic is the double-frequency one and thanks to the additional suppression provided by the Lant inductor its level is under -50 dBm.

## 8. EMC Compliance Recommendations

### 8.1 Recommendations for 2.4 GHz ETSI EN 300-328 compliance

As it was shown in the previous chapter, the radiated power of the fundamental of the BRD4162A Mighty Gecko Radio Board complies with the 20 dBm limit of the ETSI EN 300-328 both in case of the conducted and the radiated measurements. The harmonic emissions are under the -30 dBm limit. Although the BRD4162A Radio Board has an option for mounting a shielding can, that is not required for the compliance.

### 8.2 Recommendations for 2.4 GHz FCC 15.247 compliance

As it was shown in the previous chapter, the radiated power of the fundamental of the BRD4162A Mighty Gecko Radio Board complies with the 30 dBm limit of the FCC 15.247. The harmonic emissions are under the -37.6 dBm applied limit both in case of the conducted and the radiated measurements. Although the BRD4162A Radio Board has an option for mounting a shielding can, that is not required for the compliance.

## 9. Document Revision History

Table 9.1. Document Revision History

Revision Number	Effective Date	Change Description
1.00	28.2.2017	Initial release.

## 10. Board Revision History

Table 10.1. BRD4162A Radio Board Revisions

Radio Board Revision	Description
A02	Fixing EFR32 pin names; Updated PCB revision.
A01	Updated EFR32 chip revision and 32 kHz crystal part number.
A00	Initial version.

## 11. Errata

There are no known errata at present.

---

# Table of Contents

<b>1. Introduction</b>	<b>1</b>
<b>2. Radio Board Connector</b>	<b>2</b>
2.1 Introduction	2
2.2 Radio Board Connector Pin Associations	2
<b>3. Radio Board Block Summary</b>	<b>3</b>
3.1 Introduction	3
3.2 Radio Board Block Diagram	3
3.3 Radio Board Block Description	3
3.3.1 Wireless MCU	3
3.3.2 LF Crystal Oscillator (LFXO)	3
3.3.3 HF Crystal Oscillator (HFXO)	3
3.3.4 Matching Network for 2.4 GHz	4
3.3.5 Inverted-F Antenna	4
3.3.6 UFL Connector	4
3.3.7 Radio Board Connectors	4
3.3.8 Capacitive Touch Slider	4
<b>4. RF Section</b>	<b>5</b>
4.1 Introduction	5
4.2 Schematic of the RF Matching Network	5
4.2.1 Description of the 2.4 GHz RF Matching	5
4.3 RF Section Power Supply	5
4.4 Bill of Materials for the 2.4 GHz Matching	5
4.5 Inverted-F Antenna	6
<b>5. Mechanical Details</b>	<b>7</b>
<b>6. EMC Compliance</b>	<b>8</b>
6.1 Introduction	8
6.2 EMC Regulations for 2.4 GHz	8
6.2.1 ETSI EN 300-328 Emission Limits for the 2400-2483.5 MHz Band	8
6.2.2 FCC15.247 Emission Limits for the 2400-2483.5 MHz Band	8
6.2.3 Applied Emission Limits for the 2.4 GHz Band	8
<b>7. RF Performance</b>	<b>9</b>
7.1 Conducted Power Measurements	9
7.1.1 Conducted Measurements in the 2.4 GHz band	9
7.2 Radiated Power Measurements	10
7.2.1 Radiated Measurements in the 2.4 GHz band	10
<b>8. EMC Compliance Recommendations</b>	<b>11</b>
8.1 Recommendations for 2.4 GHz ETSI EN 300-328 compliance	11
8.2 Recommendations for 2.4 GHz FCC 15.247 compliance	11



---

<b>9. Document Revision History . . . . .</b>	<b>12</b>
<b>10. Board Revision History . . . . .</b>	<b>13</b>
<b>11. Errata . . . . .</b>	<b>14</b>
<b>Table of Contents . . . . .</b>	<b>15</b>

Silicon Labs

# Simplicity Studio™4

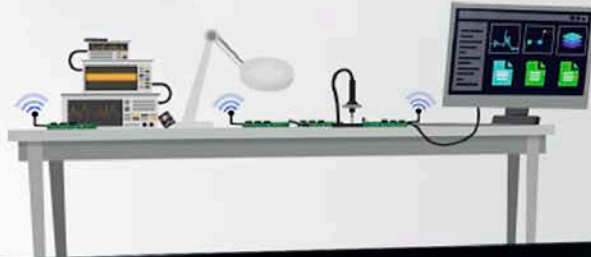

## Simplicity Studio

One-click access to MCU and wireless tools, documentation, software, source code libraries & more. Available for Windows, Mac and Linux!



IoT Portfolio  
[www.silabs.com/IoT](http://www.silabs.com/IoT)



SW/HW  
[www.silabs.com/simplicity](http://www.silabs.com/simplicity)



Quality  
[www.silabs.com/quality](http://www.silabs.com/quality)



Support and Community  
[community.silabs.com](http://community.silabs.com)

### Disclaimer

Silicon Labs intends to provide customers with the latest, accurate, and in-depth documentation of all peripherals and modules available for system and software implementers using or intending to use the Silicon Labs products. Characterization data, available modules and peripherals, memory sizes and memory addresses refer to each specific device, and "Typical" parameters provided can and do vary in different applications. Application examples described herein are for illustrative purposes only. Silicon Labs reserves the right to make changes without further notice and limitation to product information, specifications, and descriptions herein, and does not give warranties as to the accuracy or completeness of the included information. Silicon Labs shall have no liability for the consequences of use of the information supplied herein. This document does not imply or express copyright licenses granted hereunder to design or fabricate any integrated circuits. The products are not designed or authorized to be used within any Life Support System without the specific written consent of Silicon Labs. A "Life Support System" is any product or system intended to support or sustain life and/or health, which, if it fails, can be reasonably expected to result in significant personal injury or death. Silicon Labs products are not designed or authorized for military applications. Silicon Labs products shall under no circumstances be used in weapons of mass destruction including (but not limited to) nuclear, biological or chemical weapons, or missiles capable of delivering such weapons.

### Trademark Information

Silicon Laboratories Inc.®, Silicon Laboratories®, Silicon Labs®, SiLabs® and the Silicon Labs logo®, Bluegiga®, Bluegiga Logo®, Clockbuilder®, CMEMS®, DSPPLL®, EFM®, EFM32®, EFR®, Ember®, Energy Micro, Energy Micro logo and combinations thereof, "the world's most energy friendly microcontrollers", Ember®, EZLink®, EZRadio®, EZRadioPRO®, Gecko®, ISOModem®, Precision32®, ProSLIC®, Simplicity Studio®, SiPHY®, Telegesis, the Telegesis Logo®, USBXpress® and others are trademarks or registered trademarks of Silicon Labs. ARM, CORTEX, Cortex-M3 and THUMB are trademarks or registered trademarks of ARM Holdings. Keil is a registered trademark of ARM Limited. All other products or brand names mentioned herein are trademarks of their respective holders.



Silicon Laboratories Inc.  
400 West Cesar Chavez  
Austin, TX 78701  
USA

<http://www.silabs.com>