

TACT SWITCH DTS(G)-6 SERIES

6x6 Through Hole & Ground Terminal Type

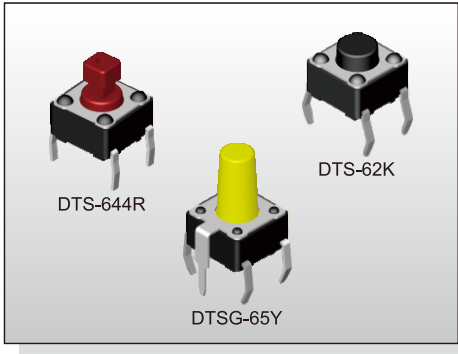

FEATURES

- ※ Compact size 6x6mm
- ※ Sharp tactile feeling
- ※ Cap options

APPLICATION

- ※ Audio, OA equipment
- ※ Instrumentation
- ※ Industrial

SPECIFICATION

Contact Rating	50mA, 12V DC
Contact Resistance	100mΩ max.
Insulation Resistance	100MΩ min. 500V DC
Dielectric Strength	250V AC/1 minute
Operating Force	70±30gf, Blue(U) 100±50gf, Black(K) 160±50gf, Brown(N) 260±50gf, Red(R) 320±80gf, Salmon(S) 520±130gf, Yellow(Y)
Travel	0.25mm
Operating Life	Phosphor Bronze Dome 50,000 cycles for 520/320gf 100,000 cycles for 260gf 200,000 cycles for 160/100/70gf
	Stainless Steel Dome 300,000 cycles for 520/320gf 500,000 cycles for 260gf 1,000,000 cycles for 160/100/70gf
Operating Temp.	-25°C ~ +70°C
Storage Temp.	-30°C ~ +80°C

HOW TO ORDER

D T S - 6

=Without Ground Pin
G=With Ground Pin

Height:
1=4.30mm
2=5.00mm
3=7.00mm
44=7.30mm (SQ.)x2.40mm
48=7.30mm (SQ.)x2.80mm
5=9.50mm
6=13.00mm
8=11.30mm
9=19.50mm

Package:
=Bulk pack
▲B=Tube
(▲DTS-61, 62 Only)

V=RoHS & Lead Free Solderable
Q=Halogen Free

=Phosphor Bronze Dome
S=Stainless Steel Dome

Operating Force:
U=Blue, 70gf
K=Black, 100gf
N=Brown, 160gf
R=Red, 260gf
S=Salmon, 320gf
Y=Yellow, 520gf

PACKAGE

<Bag>
1000 pcs
<Tub>
DTS-61/62: 75 pcs

CIRCUIT

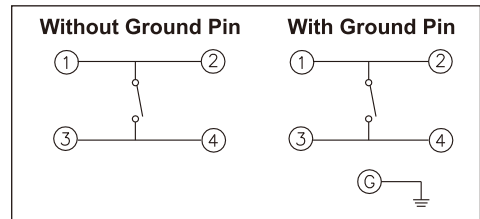

DTS-6

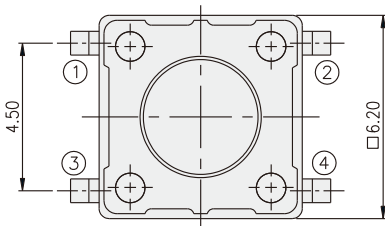

PART NO.	H
DTS-61	4.30
DTS-62	5.00
DTS-63	7.00
DTS-65	9.50
DTS-66	13.00
DTS-68	11.30
DTS-69	19.50

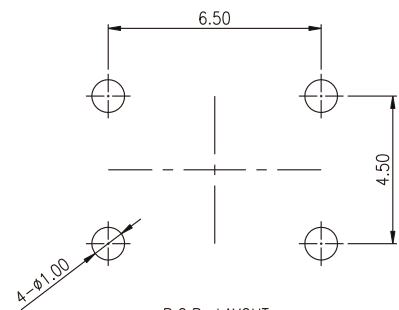
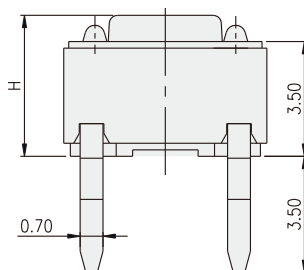
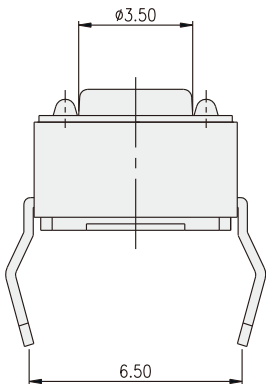

P.C.B. LAYOUT

TACT SWITCH

DTS-644(8)



PART NO.	□A	□B
DTS-644	2.40	1.60
DTS-648	2.80	2.00



TACT SWITCH

DTSG-6

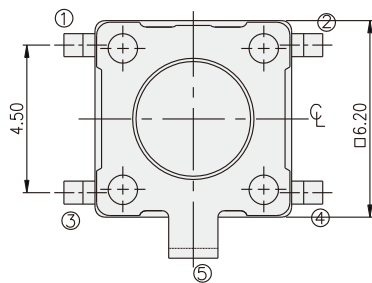

PART NO.	H
DTSG-61	4.30
DTSG-62	5.00
DTSG-63	7.00
DTSG-65	9.50
DTSG-66	13.00
DTSG-68	11.30
DTSG-69	19.50

