

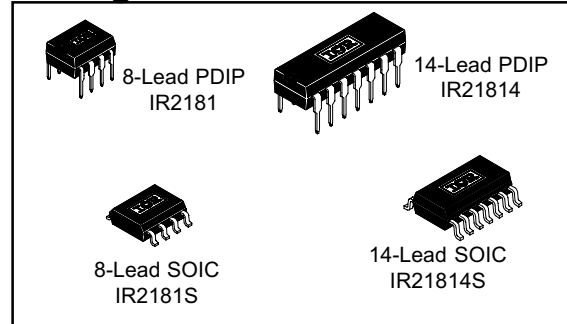
## IR2181(4)(S) & (PbF)

### HIGH AND LOW SIDE DRIVER

#### Features

- Floating channel designed for bootstrap operation  
Fully operational to +600V  
Tolerant to negative transient voltage  
dV/dt immune
- Gate drive supply range from 10 to 20V
- Undervoltage lockout for both channels
- 3.3V and 5V input logic compatible
- Matched propagation delay for both channels
- Logic and power ground +/- 5V offset.
- Lower di/dt gate driver for better noise immunity
- Output source/sink current capability 1.4A/1.8A
- Also available LEAD-FREE (PbF)

#### Packages



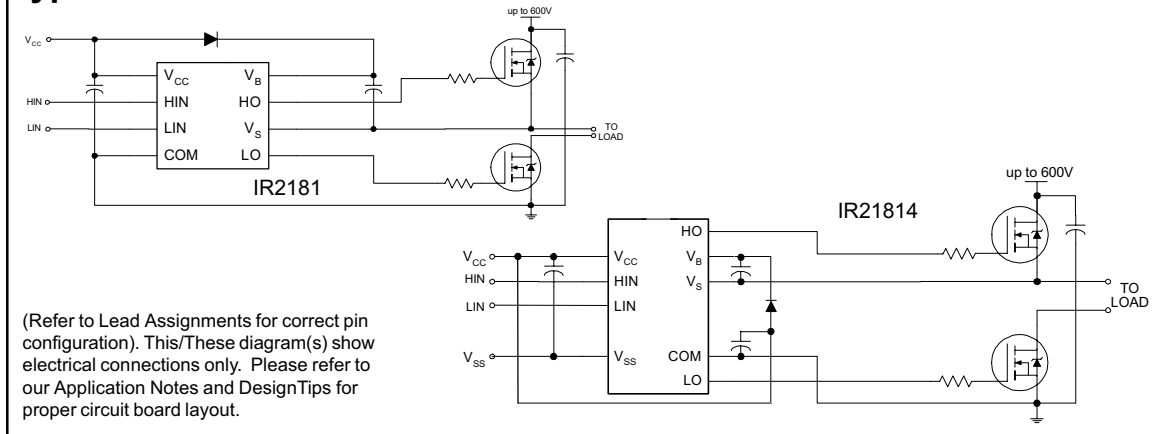
#### IR2181/IR2183/IR2184 Feature Comparison

Part	Input logic	Cross-conduction prevention logic	Dead-Time	Ground Pins	Ton/Toff
2181	HIN/LIN	no	none	COM	180/220 ns
21814				VSS/COM	
2183	HIN/LIN	yes	Internal 500ns	COM	180/220 ns
21834			Program 0.4 ~ 5 us	VSS/COM	
2184	IN/ $\overline{SD}$	yes	Internal 500ns	COM	680/270 ns
21844			Program 0.4 ~ 5 us	VSS/COM	

#### Description

The IR2181(4)(S) are high voltage, high speed power MOSFET and IGBT drivers with independent high and low side referenced output channels. Proprietary HVIC and latch immune CMOS technologies enable ruggedized monolithic construction. The logic input is compatible with standard CMOS or LSTTL output, down to 3.3V logic. The output drivers feature a high pulse current buffer stage designed for minimum driver cross-conduction. The floating channel can be used to drive an N-channel power MOSFET or IGBT in the high side configuration which operates up to 600 volts.

#### Typical Connection



# IR2181(4) (S) & (PbF)

## Absolute Maximum Ratings

Absolute maximum ratings indicate sustained limits beyond which damage to the device may occur. All voltage parameters are absolute voltages referenced to COM. The thermal resistance and power dissipation ratings are measured under board mounted and still air conditions.

Symbol	Definition	Min.	Max.	Units	
V <sub>B</sub>	High side floating absolute voltage	-0.3	625	V	
V <sub>S</sub>	High side floating supply offset voltage	V <sub>B</sub> - 25	V <sub>B</sub> + 0.3		
V <sub>HO</sub>	High side floating output voltage	V <sub>S</sub> - 0.3	V <sub>B</sub> + 0.3		
V <sub>CC</sub>	Low side and logic fixed supply voltage	-0.3	25		
V <sub>LO</sub>	Low side output voltage	-0.3	V <sub>CC</sub> + 0.3		
V <sub>IN</sub>	Logic input voltage (HIN & LIN - IR2181/IR21814)	V <sub>SS</sub> - 0.3	V <sub>SS</sub> + 10		
V <sub>SS</sub>	Logic ground (IR21814 only)	V <sub>CC</sub> - 25	V <sub>CC</sub> + 0.3		
dV <sub>S</sub> /dt	Allowable offset supply voltage transient	—	50	V/ns	
P <sub>D</sub>	Package power dissipation @ T <sub>A</sub> ≤ +25°C	(8-lead PDIP)	—	1.0	W
		(8-lead SOIC)	—	0.625	
		(14-lead PDIP)	—	1.6	
		(14-lead SOIC)	—	1.0	
R <sub>thJA</sub>	Thermal resistance, junction to ambient	(8-lead PDIP)	—	125	°C/W
		(8-lead SOIC)	—	200	
		(14-lead PDIP)	—	75	
		(14-lead SOIC)	—	120	
T <sub>J</sub>	Junction temperature	—	150	°C	
T <sub>S</sub>	Storage temperature	-50	150		
T <sub>L</sub>	Lead temperature (soldering, 10 seconds)	—	300		

## Recommended Operating Conditions

The Input/Output logic timing diagram is shown in figure 1. For proper operation the device should be used within the recommended conditions. The V<sub>S</sub> and V<sub>SS</sub> offset rating are tested with all supplies biased at 15V differential.

Symbol	Definition	Min.	Max.	Units
V <sub>B</sub>	High side floating supply absolute voltage	V <sub>S</sub> + 10	V <sub>S</sub> + 20	V
V <sub>S</sub>	High side floating supply offset voltage	Note 1	600	
V <sub>HO</sub>	High side floating output voltage	V <sub>S</sub>	V <sub>B</sub>	
V <sub>CC</sub>	Low side and logic fixed supply voltage	10	20	
V <sub>LO</sub>	Low side output voltage	0	V <sub>CC</sub>	
V <sub>IN</sub>	Logic input voltage (HIN & LIN - IR2181/IR21814)	V <sub>SS</sub>	V <sub>SS</sub> + 5	
V <sub>SS</sub>	Logic ground (IR21814/IR21824 only)	-5	5	
T <sub>A</sub>	Ambient temperature	-40	125	°C

Note 1: Logic operational for V<sub>S</sub> of -5 to +600V. Logic state held for V<sub>S</sub> of -5V to -V<sub>BS</sub>. (Please refer to the Design Tip DT97-3 for more details).

Note 2: HIN and LIN pins are internally clamped with a 5.2V zener diode.

### Dynamic Electrical Characteristics

V<sub>BIAS</sub> (V<sub>CC</sub>, V<sub>BS</sub>) = 15V, V<sub>SS</sub> = COM, C<sub>L</sub> = 1000 pF, T<sub>A</sub> = 25°C.

Symbol	Definition	Min.	Typ.	Max.	Units	Test Conditions
t <sub>on</sub>	Turn-on propagation delay	—	180	270	nsec	V <sub>S</sub> = 0V
t <sub>off</sub>	Turn-off propagation delay	—	220	330		V <sub>S</sub> = 0V or 600V
MT	Delay matching, HS & LS turn-on/off	—	0	35		
t <sub>r</sub>	Turn-on rise time	—	40	60		V <sub>S</sub> = 0V
t <sub>f</sub>	Turn-off fall time	—	20	35		V <sub>S</sub> = 0V

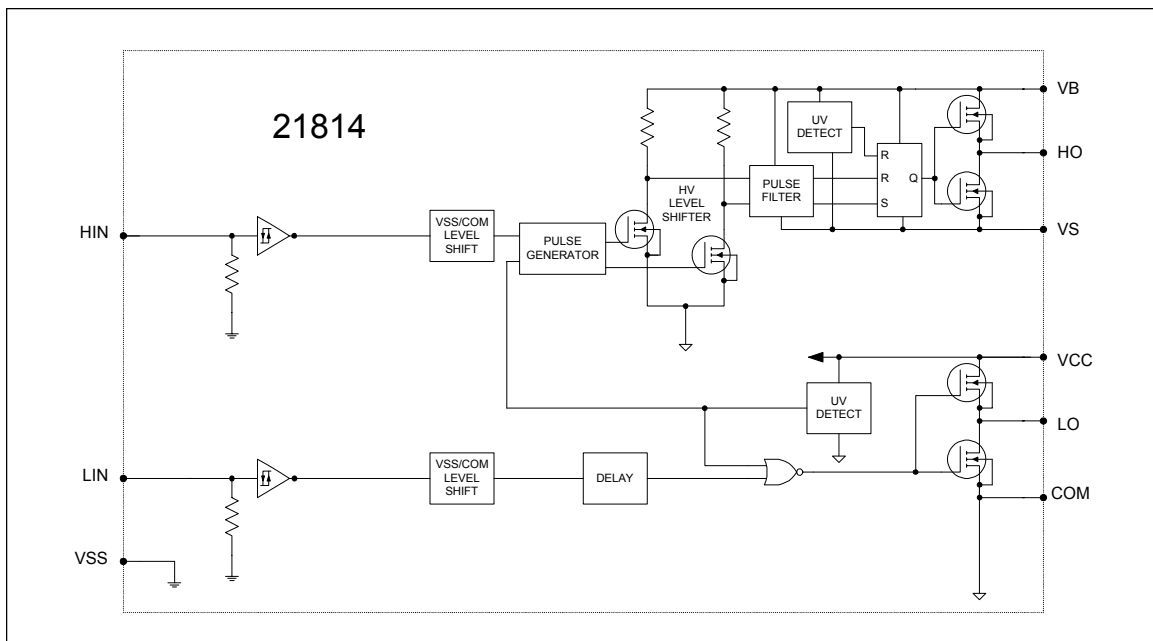
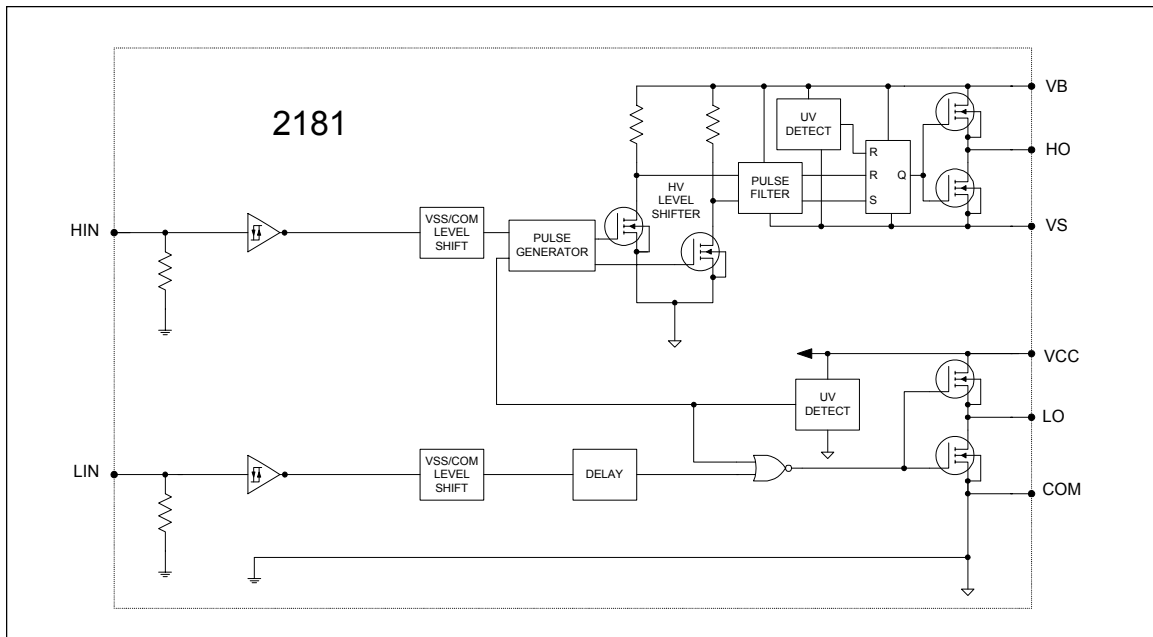
### Static Electrical Characteristics

V<sub>BIAS</sub> (V<sub>CC</sub>, V<sub>BS</sub>) = 15V, V<sub>SS</sub> = COM and T<sub>A</sub> = 25°C unless otherwise specified. The V<sub>IL</sub>, V<sub>IH</sub> and I<sub>IN</sub> parameters are referenced to V<sub>SS</sub>/COM and are applicable to the respective input leads HIN and LIN. The V<sub>O</sub>, I<sub>O</sub> and Ron parameters are referenced to COM and are applicable to the respective output leads: HO and LO.

Symbol	Definition	Min.	Typ.	Max.	Units	Test Conditions
V <sub>IH</sub>	Logic "1" input voltage (IR2181/IR21814 )	2.7	—	—	V	V <sub>CC</sub> = 10V to 20V
V <sub>IL</sub>	Logic "0" input voltage (IR2181/IR21814)	—	—	0.8		V <sub>CC</sub> = 10V to 20V
V <sub>OH</sub>	High level output voltage, V <sub>BIAS</sub> - V <sub>O</sub>	—	—	1.2		I <sub>O</sub> = 0A
V <sub>OL</sub>	Low level output voltage, V <sub>O</sub>	—	—	0.1		I <sub>O</sub> = 0A
I <sub>LK</sub>	Offset supply leakage current	—	—	50	μA	V <sub>B</sub> = V <sub>S</sub> = 600V
I <sub>QBS</sub>	Quiescent V <sub>BS</sub> supply current	20	60	150		V <sub>IN</sub> = 0V or 5V
I <sub>QCC</sub>	Quiescent V <sub>CC</sub> supply current	50	120	240		V <sub>IN</sub> = 0V or 5V
I <sub>IN+</sub>	Logic "1" input bias current	—	25	60		V <sub>IN</sub> = 5V
I <sub>IN-</sub>	Logic "0" input bias current	—	—	1.0		V <sub>IN</sub> = 0V
V <sub>CCUV+</sub> V <sub>BSUV+</sub>	V <sub>CC</sub> and V <sub>BS</sub> supply undervoltage positive going threshold	8.0	8.9	9.8	V	
V <sub>CCUV-</sub> V <sub>BSUV-</sub>	V <sub>CC</sub> and V <sub>BS</sub> supply undervoltage negative going threshold	7.4	8.2	9.0		
V <sub>CCUVH</sub> V <sub>BSUVH</sub>	Hysteresis	0.3	0.7	—		
I <sub>O+</sub>	Output high short circuit pulsed current	1.4	1.9	—	A	V <sub>O</sub> = 0V, PW ≤ 10 μs
I <sub>O-</sub>	Output low short circuit pulsed current	1.8	2.3	—		V <sub>O</sub> = 15V, PW ≤ 10 μs

# IR2181(4) (S) & (PbF)

## Functional Block Diagrams



## Lead Definitions

Symbol	Description
HIN	Logic input for high side gate driver output (HO), in phase (IR2181/IR21814)
LIN	Logic input for low side gate driver output (LO), in phase (IR2181/IR21814)
VSS	Logic Ground (IR21814 only)
V <sub>B</sub>	High side floating supply
HO	High side gate drive output
V <sub>S</sub>	High side floating supply return
V <sub>CC</sub>	Low side and logic fixed supply
LO	Low side gate drive output
COM	Low side return

## Lead Assignments

<p>8-Lead PDIP</p>	<p>8-Lead SOIC</p>
<b>IR2181</b>	<b>IR2181S</b>
<p>14-Lead PDIP</p>	<p>14-Lead SOIC</p>
<b>IR21814</b>	<b>IR21814S</b>

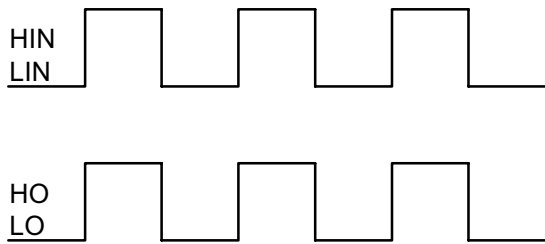


Figure 1. Input/Output Timing Diagram

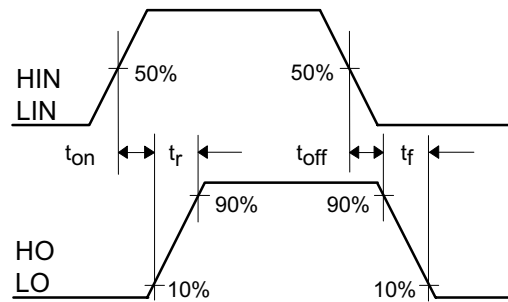


Figure 2. Switching Time Waveform Definitions

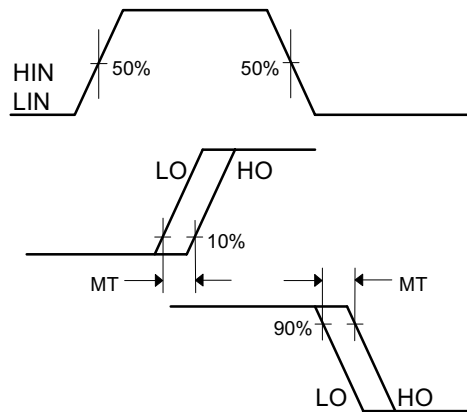
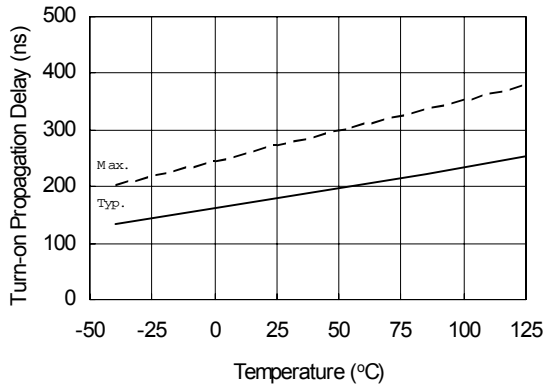
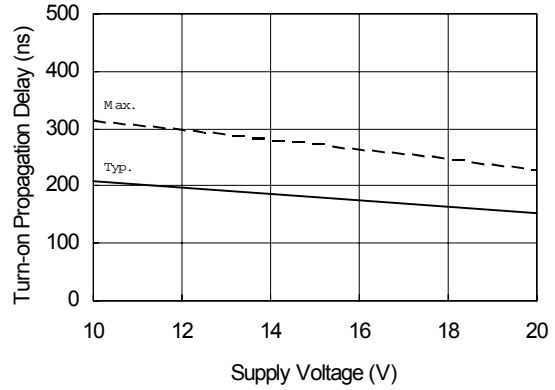


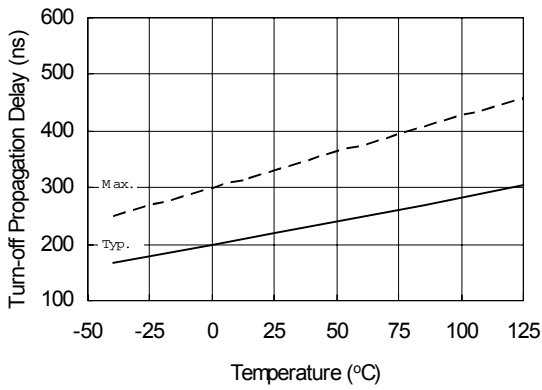
Figure 3. Delay Matching Waveform Definitions



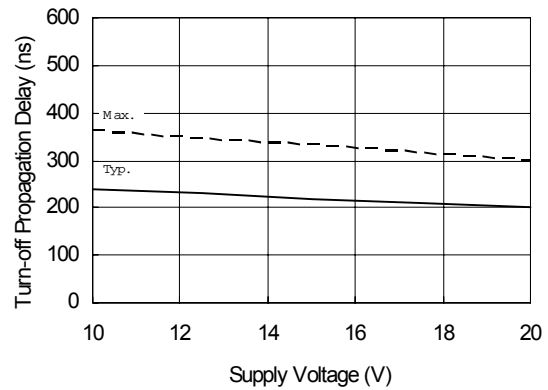
**Figure 4A. Turn-on Propagation Delay vs. Temperature**



**Figure 4B. Turn-on Propagation Delay vs. Supply Voltage**



**Figure 5A. Turn-off Propagation Delay vs. Temperature**



**Figure 5B. Turn-off Propagation Delay vs. Supply Voltage**

# IR2181(4) (S) & (PbF)

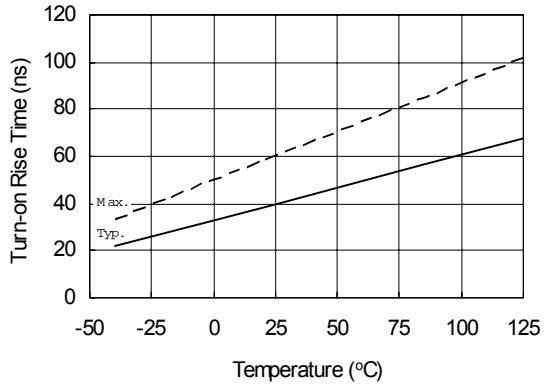


Figure 6A. Turn-on Rise Time vs. Temperature

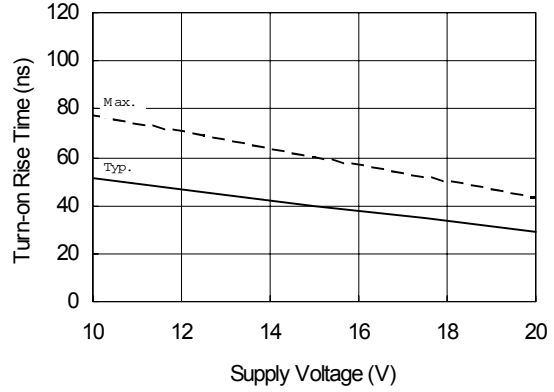


Figure 6B. Turn-on Rise Time vs. Supply Voltage

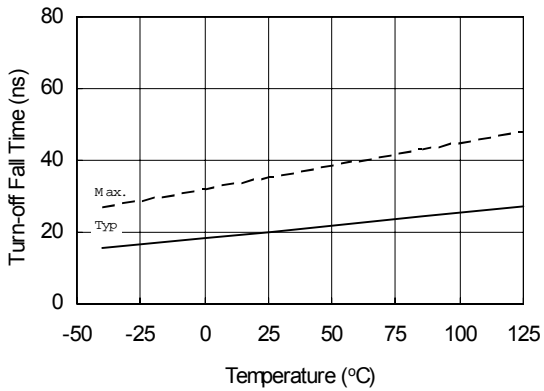


Figure 7A. Turn-off Fall Time vs. Temperature

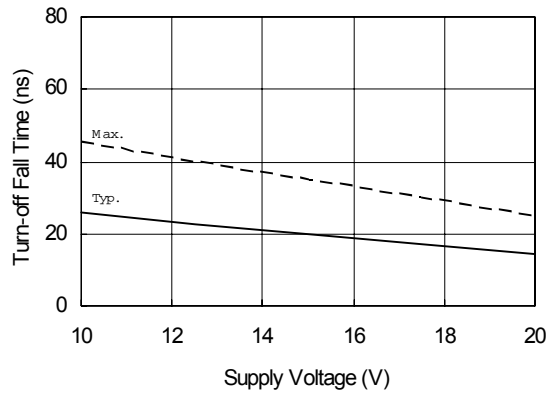
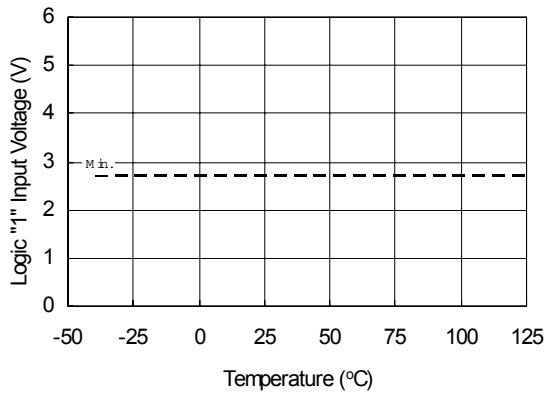
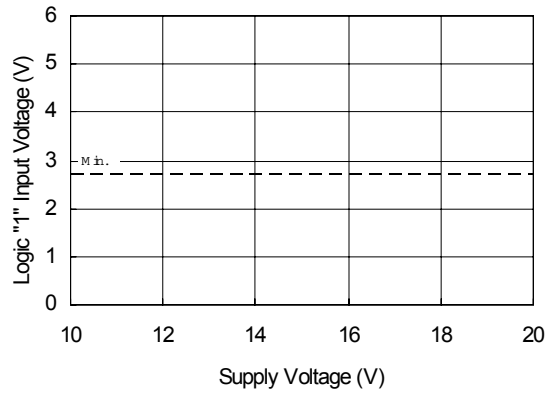


Figure 7B. Turn-off Fall Time vs. Supply Voltage

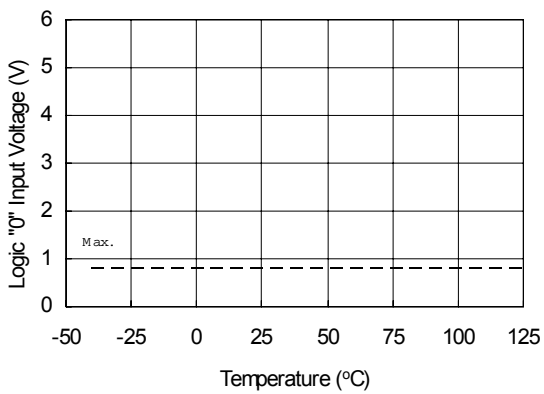




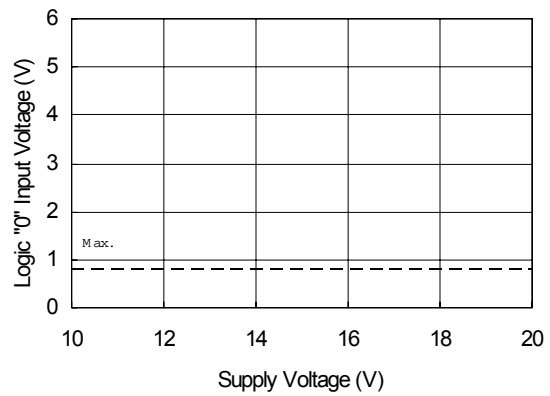
**Figure 8A. Logic "1" Input Voltage vs. Temperature**



**Figure 8B. Logic "1" Input Voltage vs. Supply Voltage**



**Figure 9A. Logic "0" Input Voltage vs. Temperature**



**Figure 9B. Logic "0" Input Voltage vs. Supply Voltage**

# IR2181(4) (S) & (PbF)

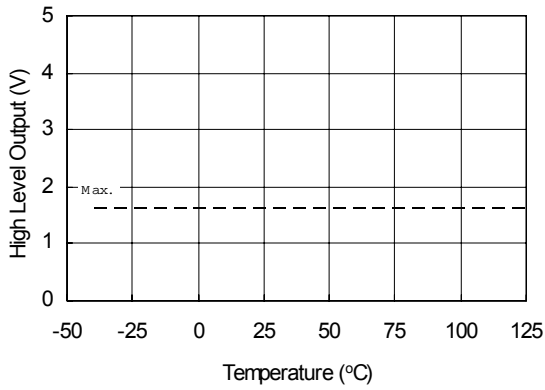


Figure 10A. High Level Output vs. Temperature

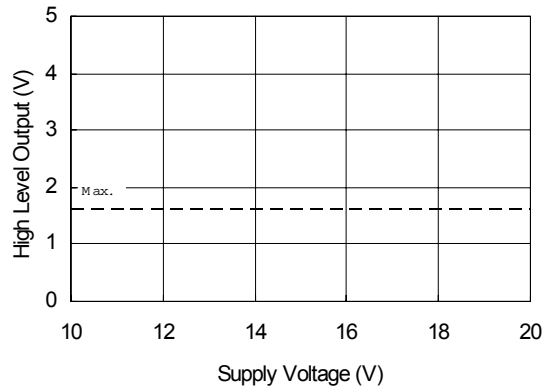


Figure 10B. High Level Output vs. Supply Voltage

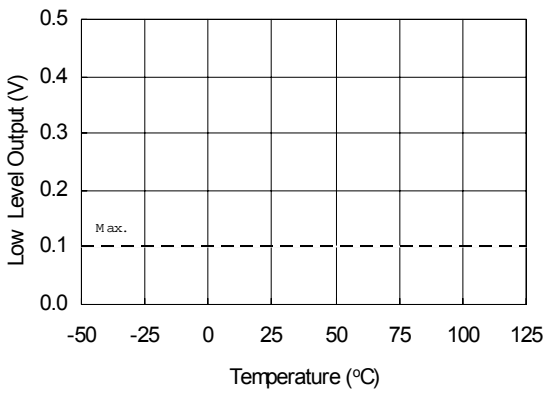


Figure 11A. Low Level Output vs. Temperature

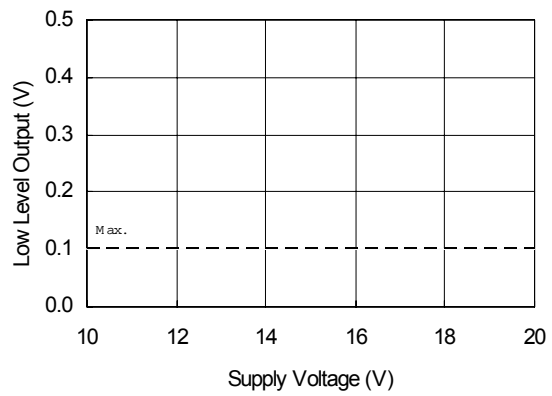


Figure 11B. Low Level Output vs. Supply Voltage

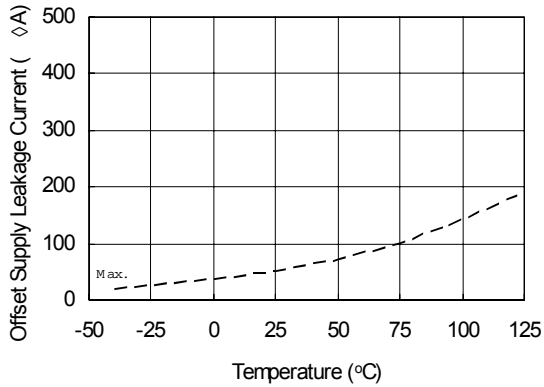


Figure 12A. Offset Supply Leakage Current vs. Temperature

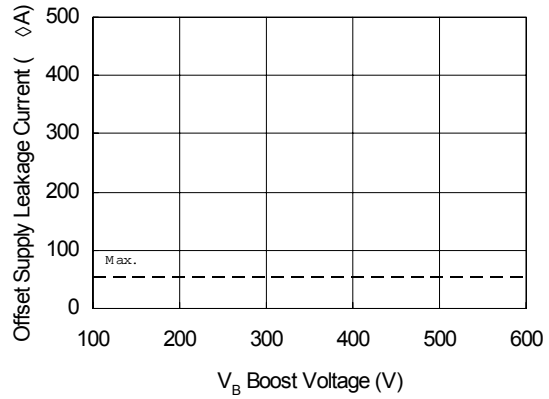


Figure 12B. Offset Supply Leakage Current vs. V<sub>B</sub> Boost Voltage

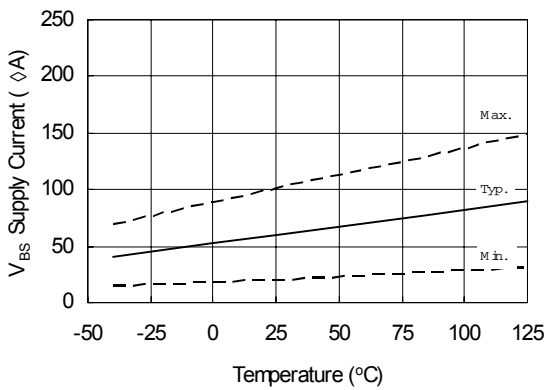


Figure 13A. V<sub>BS</sub> Supply Current vs. Temperature

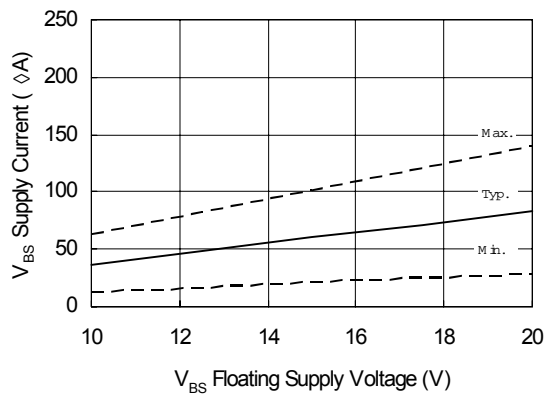
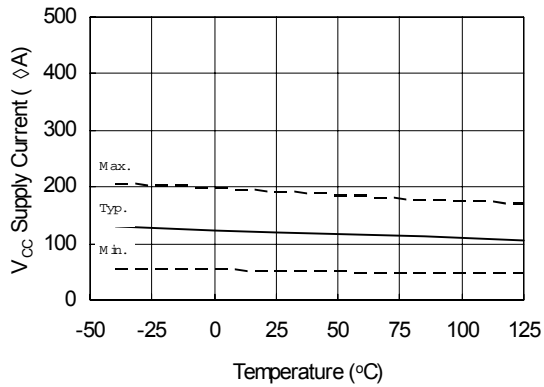
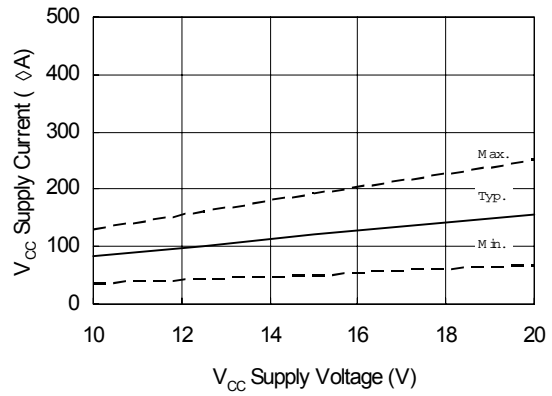


Figure 13B. V<sub>BS</sub> Supply Current vs. V<sub>BS</sub> Floating Supply Voltage

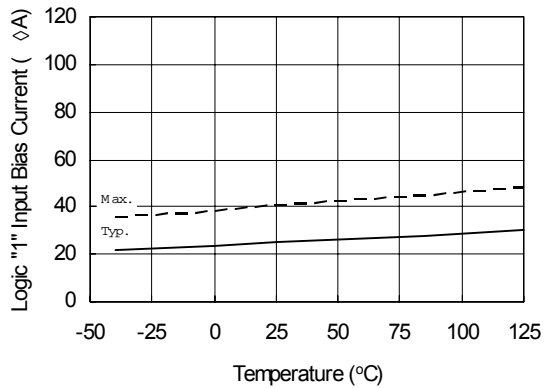
# IR2181(4) (S) & (PbF)



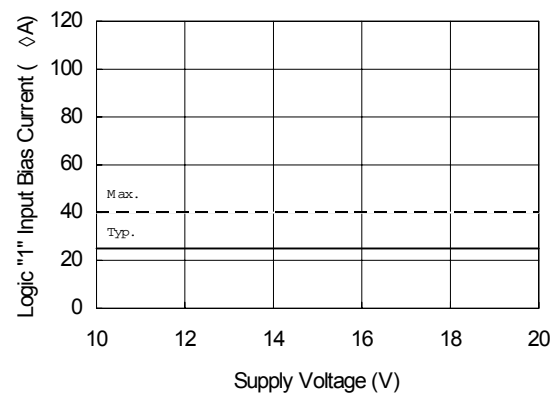
**Figure 14A. V<sub>CC</sub> Supply Current vs. V<sub>CC</sub> Temperature**



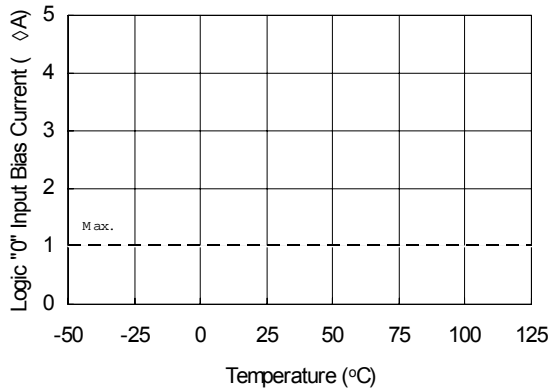
**Figure 14B. V<sub>CC</sub> Supply Current vs. V<sub>CC</sub> Supply Voltage**



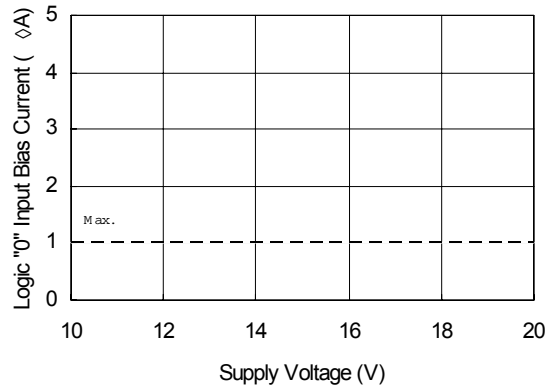
**Figure 15A. Logic "1" Input Bias Current vs. Temperature**



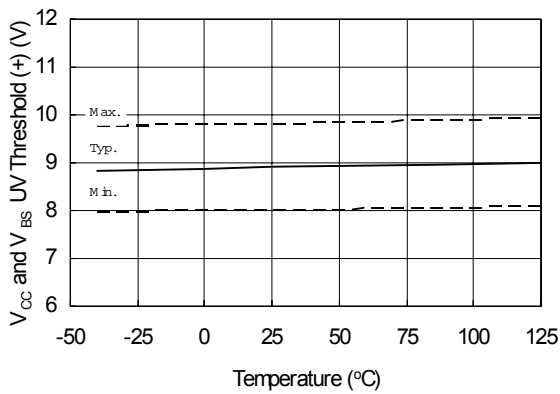
**Figure 15B. Logic "1" Input Bias Current vs. Supply Voltage**



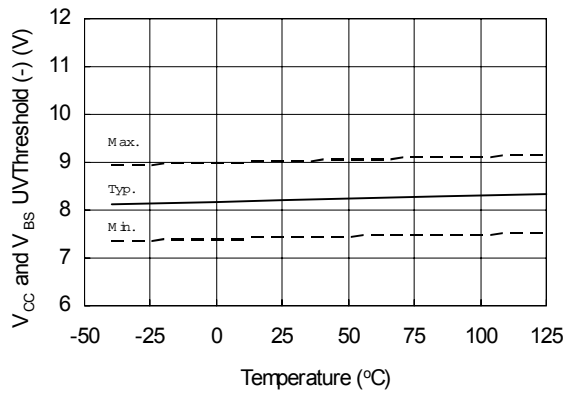
**Figure 16A. Logic "0" Input Bias Current vs. Temperature**



**Figure 16B. Logic "0" Input Bias Current vs. Supply Voltage**

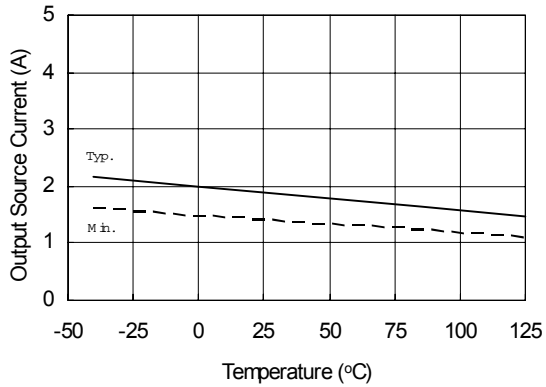


**Figure 17. V<sub>CC</sub> and V<sub>BS</sub> Undervoltage Threshold (+) vs. Temperature**

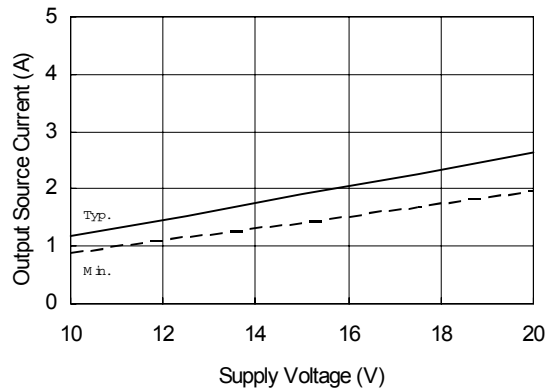


**Figure 18. V<sub>CC</sub> and V<sub>BS</sub> Undervoltage Threshold (-) vs. Temperature**

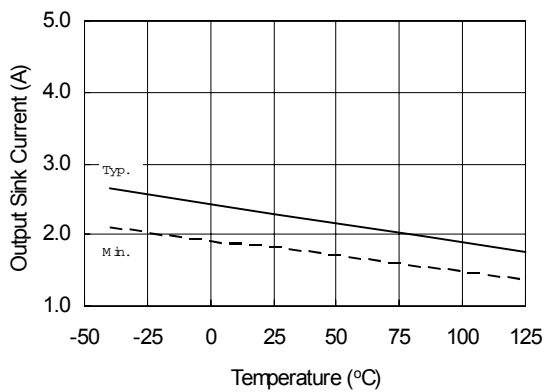
# IR2181(4) (S) & (PbF)



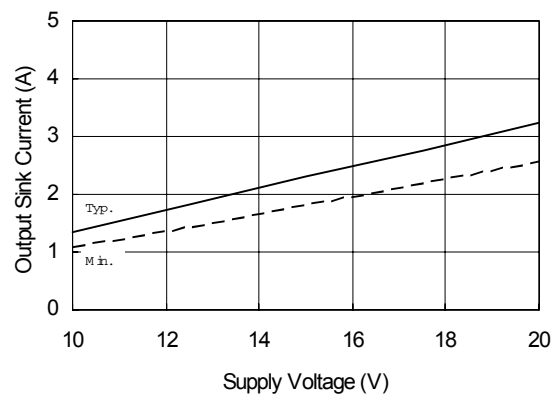
**Figure 19A. Output Source Current vs. Temperature**



**Figure 19B. Output Source Current vs. Supply Voltage**

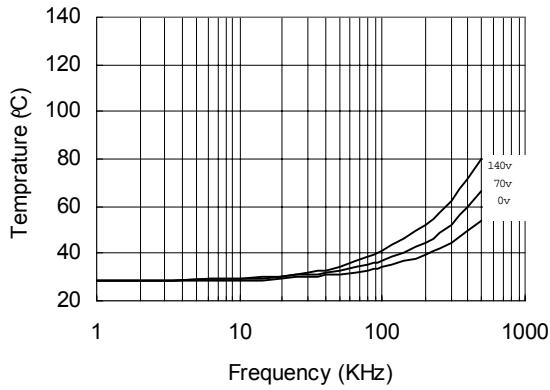


**Figure 20A. Output Sink Current vs. Temperature**

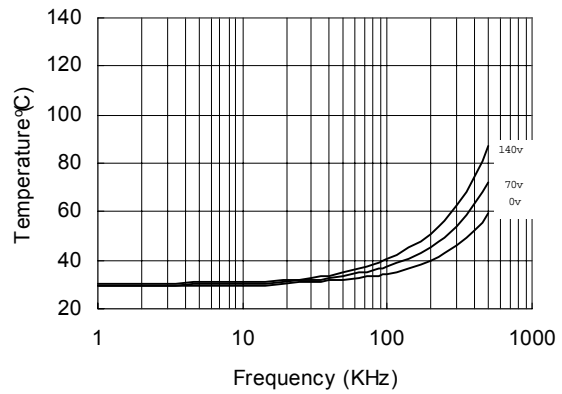


**Figure 20B. Output Sink Current vs. Supply Voltage**

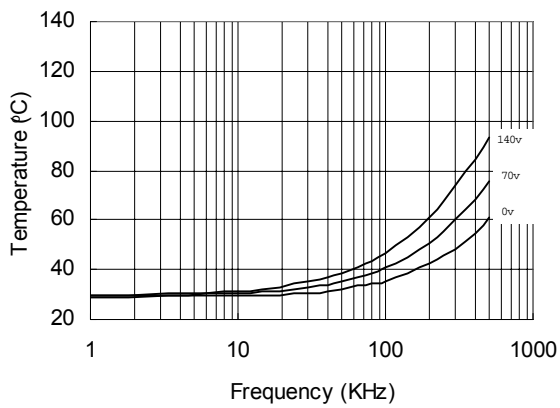
# IR2181(4) (S) & (PbF)



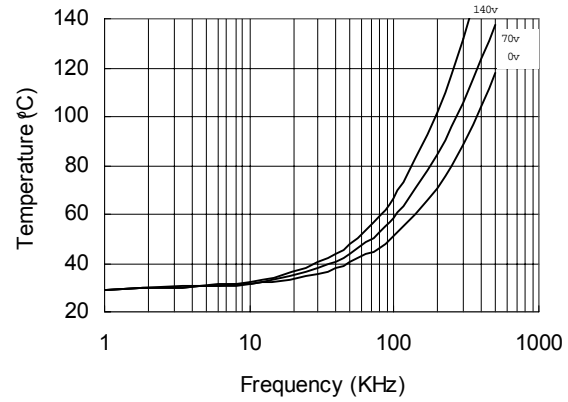
**Figure 21. IR2181 vs. Frequency (IRFBC20),  
 $R_{gate}=33\Omega, V_{CC}=15V$**



**Figure 22. IR2181 vs. Frequency (IRFBC30),  
 $R_{gate}=22\Omega, V_{CC}=15V$**



**Figure 23. IR2181 vs. Frequency (IRFBC40),  
 $R_{gate}=15\Omega, V_{CC}=15V$**



**Figure 24. IR2181 vs. Frequency (IRFPE50),  
 $R_{gate}=10\Omega, V_{CC}=15V$**

# IR2181(4) (S) & (PbF)

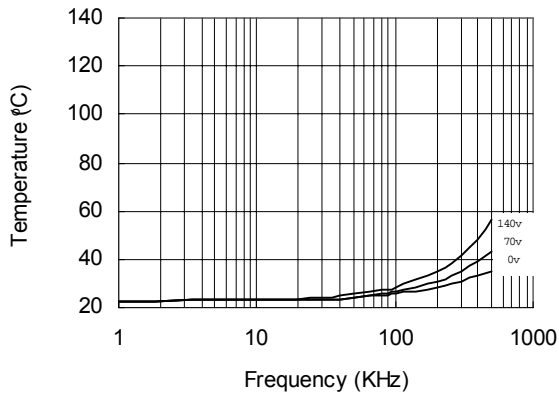


Figure 25. IR21814 vs .Frequency (IRFBC 20),  
 $R_{gate}=33\Omega, V_{CC}=15V$

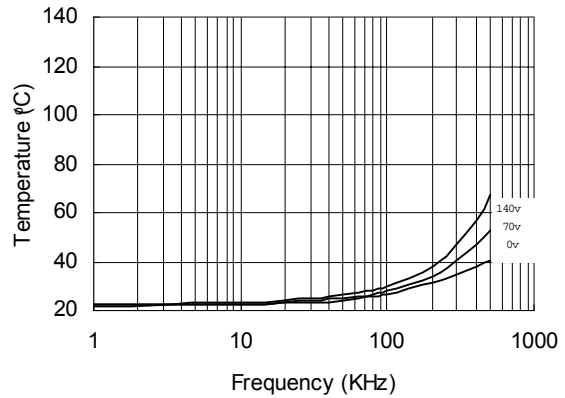


Figure 26. IR21814 vs .Frequency (IRFBC 30),  
 $R_{gate}=22\Omega, V_{CC}=15V$

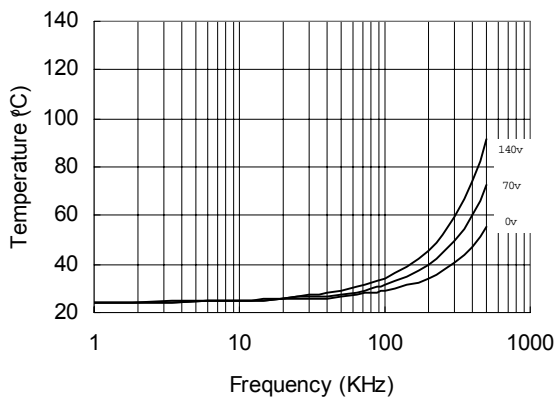


Figure 27. IR21814 vs .Frequency (IRFBC 40),  
 $R_{gate}=15\Omega, V_{CC}=15V$

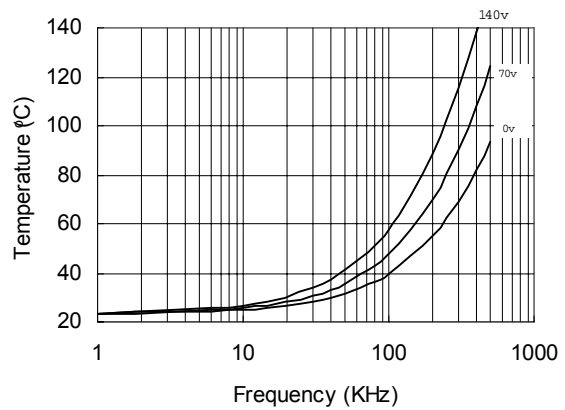


Figure 28. IR21814 vs .Frequency (IRFPE50),  
 $R_{gate}=10\Omega, V_{CC}=15V$



# IR2181(4) (S) & (PbF)

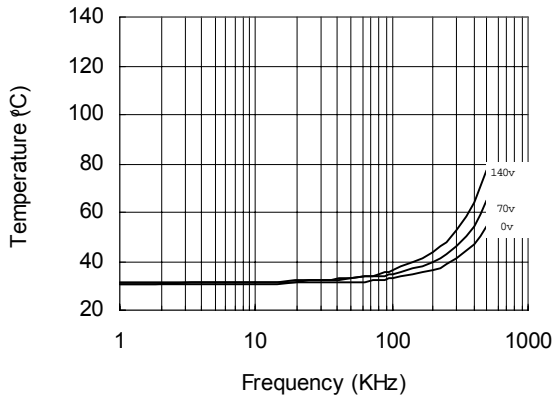


Figure 29. IR2181s vs. Frequency (IRFBC 20),  
 $R_{gate} = 33\Omega, V_{CC} = 15V$

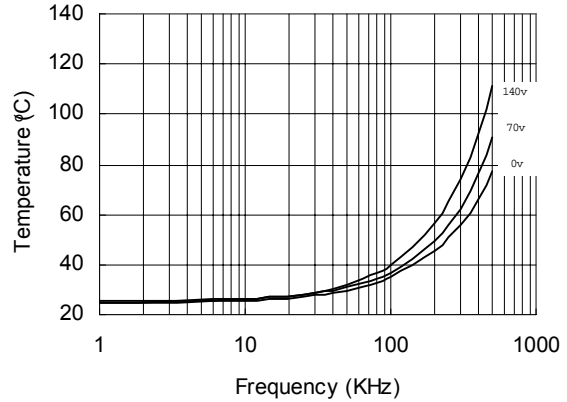


Figure 30. IR2181s vs. Frequency (IRFBC 30),  
 $R_{gate} = 22\Omega, V_{CC} = 15V$

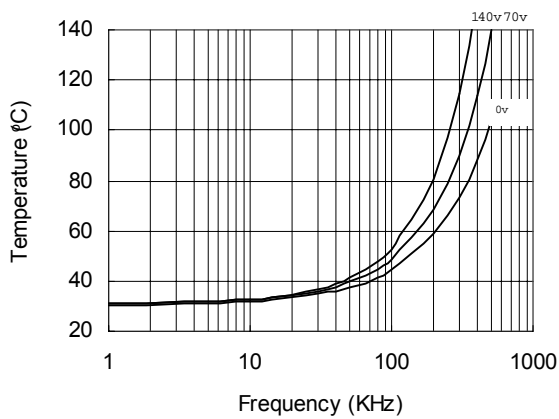


Figure 31. IR2181s vs. Frequency (IRFBC 40),  
 $R_{gate} = 15\Omega, V_{CC} = 15V$

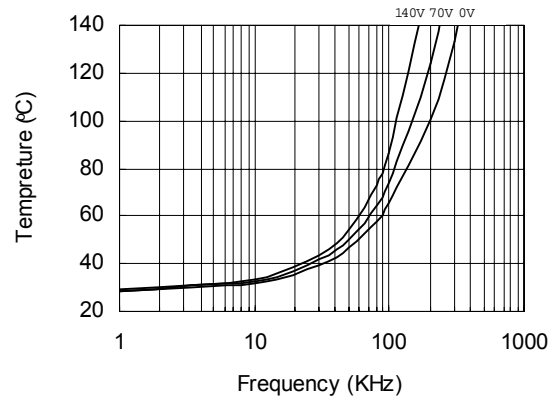


Figure 32. IR2181s vs. Frequency (IRFPE50),  
 $R_{gate} = 10\Omega, V_{CC} = 15V$

# IR2181(4) (S) & (PbF)

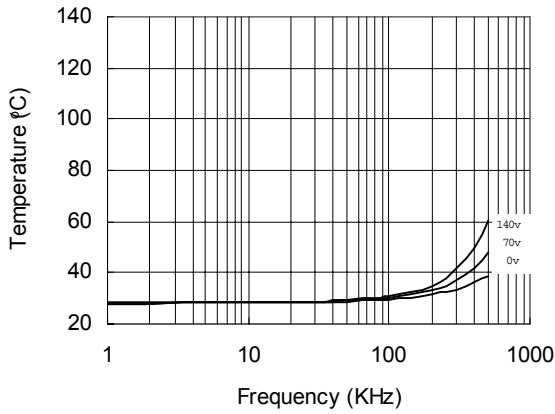


Figure 33. IR21814s vs. Frequency (RFBC 20),  
 $R_{gate} = 33\Omega, V_{CC} = 15V$

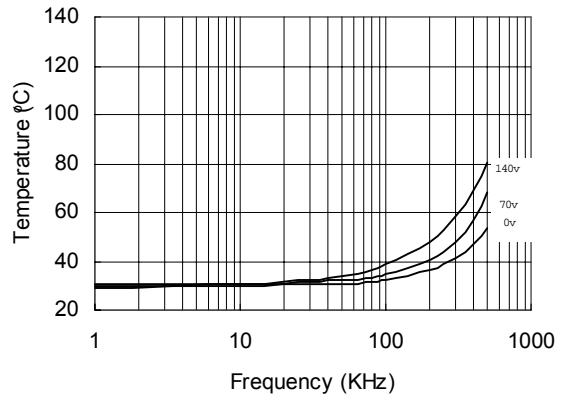


Figure 34. IR21814s vs. Frequency (RFBC 30),  
 $R_{gate} = 22\Omega, V_{CC} = 15V$

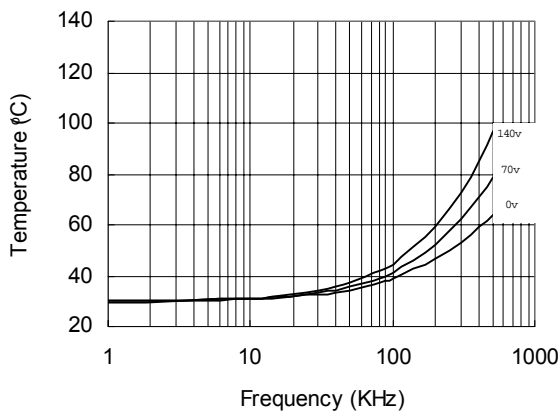


Figure 35. IR21814s vs. Frequency (RFBC 40),  
 $R_{gate} = 15\Omega, V_{CC} = 15V$

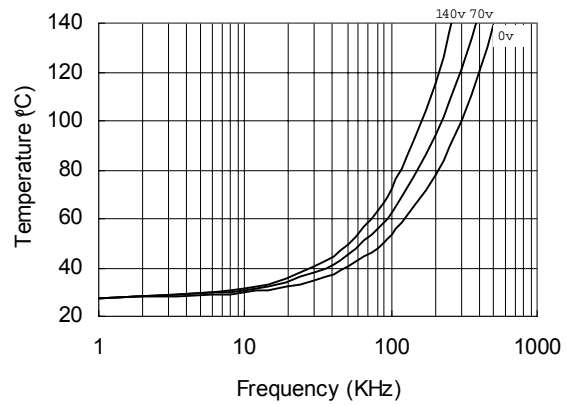
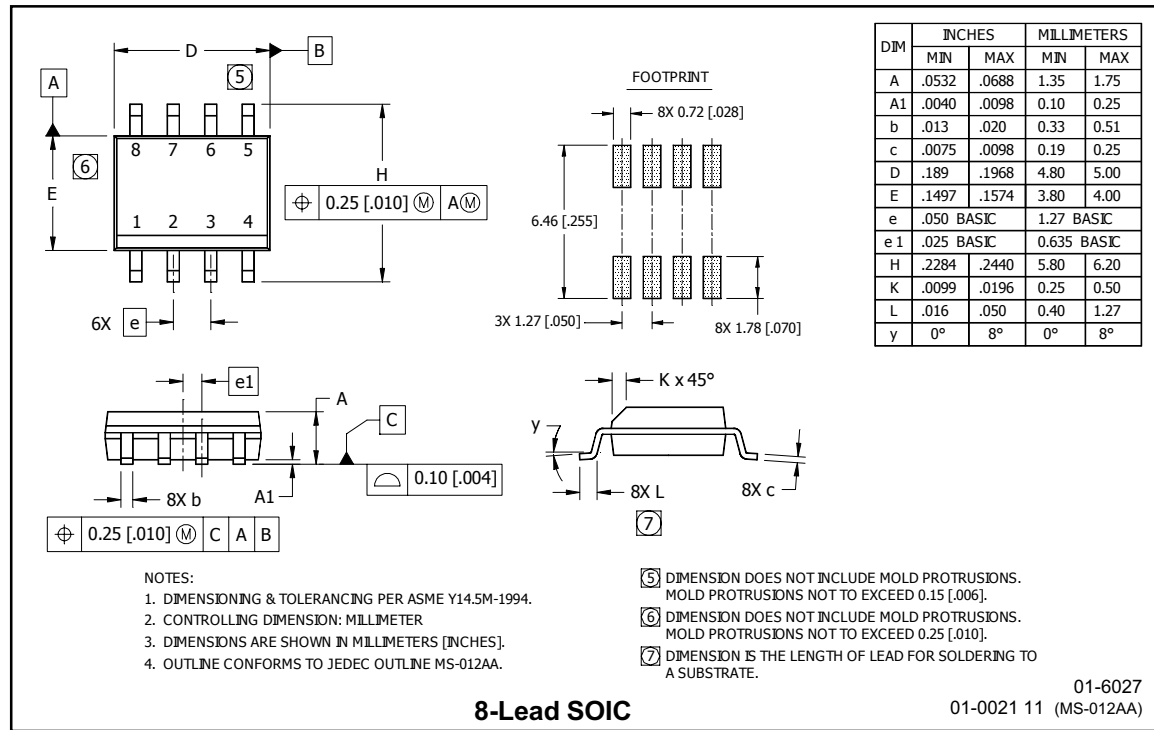
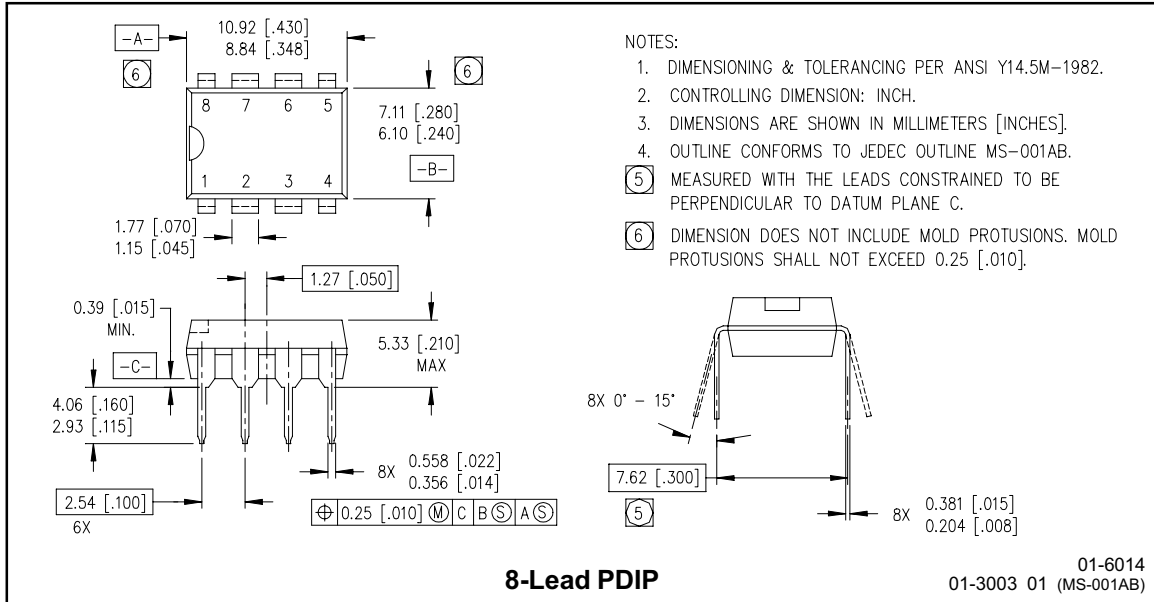


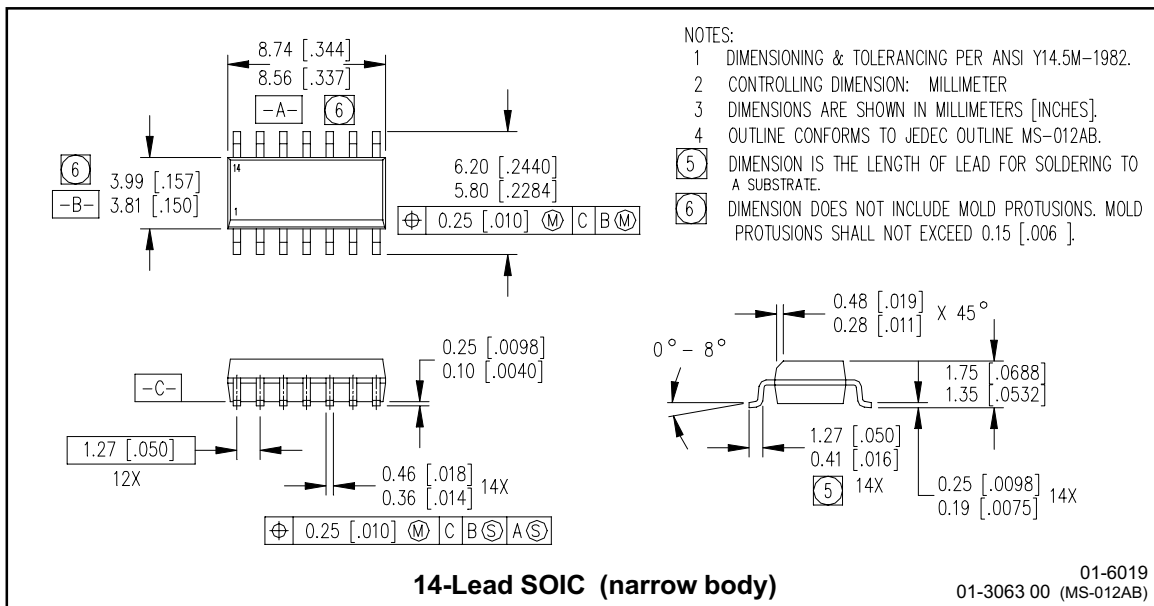
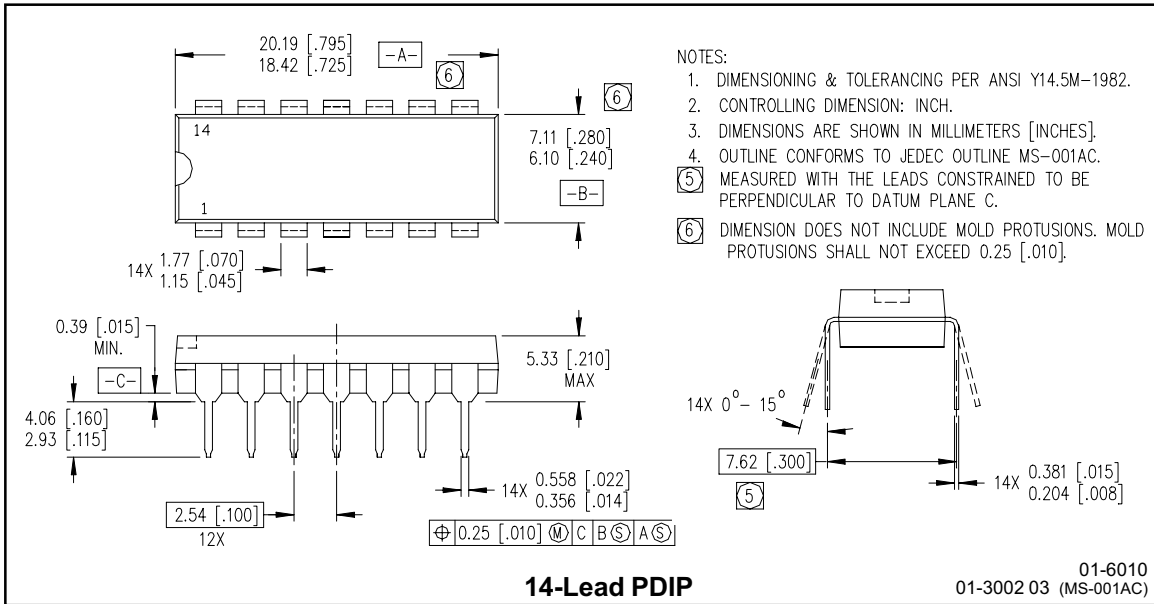
Figure 36. IR21814s vs. Frequency (RFPE50),  
 $R_{gate} = 10\Omega, V_{CC} = 15V$

## Case outlines

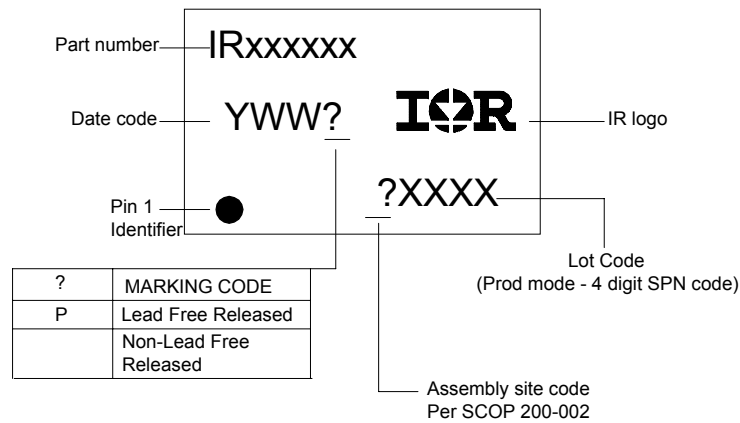


# IR2181(4) (S) & (PbF)

International  
**IR** Rectifier



## LEADFREE PART MARKING INFORMATION



## ORDER INFORMATION

### Basic Part (Non-Lead Free)

8-Lead PDIP IR2181 order IR2181  
 8-Lead SOIC IR2181S order IR2181S  
 14-Lead PDIP IR21814 order IR21814  
 14-Lead SOIC IR21814 order IR21814S

### Leadfree Part

8-Lead PDIP IR2181 order IR2181PbF  
 8-Lead SOIC IR2181S order IR2181SPbF  
 14-Lead PDIP IR21814 order IR21814PbF  
 14-Lead SOIC IR21814 order IR21814SPbF

# Mouser Electronics

Authorized Distributor

Click to View Pricing, Inventory, Delivery & Lifecycle Information:

[Infineon:](#)

[IR2181SPBF](#) [IR21814SPBF](#) [IR21814PBF](#) [IR21814STRPBF](#) [IR2181PBF](#) [IR2181STRPBF](#)