

Overview

- Distance measurement value via IO-Link
- Reliable also on very dark and shiny objects
- Manipulation-proof, simple teach-in via qTeach or line teach
- Extended parameterization options and additional diagnostic data
- Longest distances thanks to time of flight principle
- Laser light source for an accurate switching behavior



Picture similar



Technical data

General data

Type	Background suppression
Version	Time of Flight
Light source	Pulsed red laser diode
Sensing distance Tw	150 ... 2500 mm
Sensing range Tb	100 ... 2625 mm
Repeat accuracy	≤ 1200 ... 4300 µm
Temperature drift	± 15 mm
Linearity error	± 10 mm
Power on indication	LED green
Output indicator	LED yellow / LED red
Sensing distance adjustment	Teach-in and IO-Link
Laser class	1
Distance to focus	1500 mm
Wave length	680 nm
Suppression of reciprocal influence	Yes
Beam type	Point
Alignment optical axis	< 1°

Electrical data

Response time / release time	< 4 ms (High Speed Mode) < 8 ms (Standard Mode) < 50 ms (Long Range Mode)
Voltage supply range +Vs	12 ... 30 VDC
Current consumption max. (no load)	60 mA
Voltage drop Vd	< 2 VDC
Output function	Light operate, switchable
Output circuit	Push-pull / IO-Link Push-pull
Output current	< 50 mA, sum of all outputs

Electrical data

Short circuit protection	Yes
Reverse polarity protection	Yes

Communication interface

Interface	IO-Link V1.1.3
Profile	DMSS
IO-Link port type	Class A
Baud rate	230,4 kBaud (COM 3)
Cycle time	≥ 2 ms
Process data length	32 Bit
Process data structure	Bit 0 = SSC1 (distance) Bit 1 = SSC2 (distance) Bit 2 = quality Bit 3 = alarm Bit 5 = SSC4 (counter) Bit 8-15 = scale factor Bit 16-31 = 16 Bit measurement

Adjustable parameters

- Switching point
- Switching hysteresis
- Operation mode
- Time filters
- LED status indicators
- Output logic
- Output circuit
- Counter
- Deactivate the sensor element
- Find Me function
- Teach-in mode

Technical data

Communication interface

Additional data	Distance
	Excess gain
	Operating cycles
	Operating hours
	Boot cycles
	Operating voltage
	Device temperature
	Histograms

Mechanical data

Width / diameter	18 mm
Height / length	45 mm
Depth	32 mm
Type	Rectangular
Housing material	Plastic (ASA, PMMA)

Mechanical data

Front (optics)	PMMA
Connection types	Connector M12 5 pin

Ambient conditions

Protection class	IP 67
Operating temperature	-20 ... +50 °C
Storage temperature	-40 ... +70 °C
Vibration (sinusoidal)	IEC 60068-2-6:2008 10 g at f = 10 - 2000 Hz, duration 150 min per axis
Shock (semi-sinusoidal)	IEC 60068-2-27:2009 50 g / 11 ms, 10 impulses per axis and direction

Remarks

- Measurement on 90% remission (white)

Dimension drawing

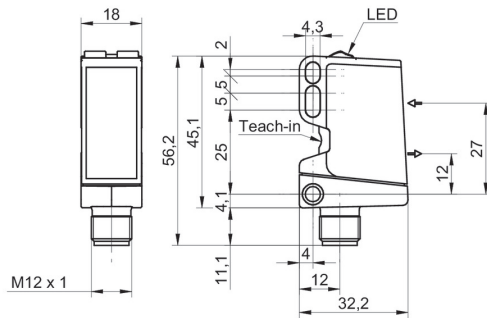

Pin assignment

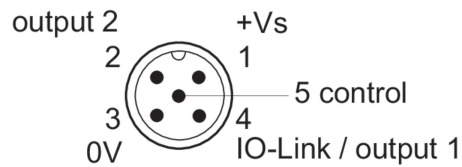

Beam characteristic (typically)

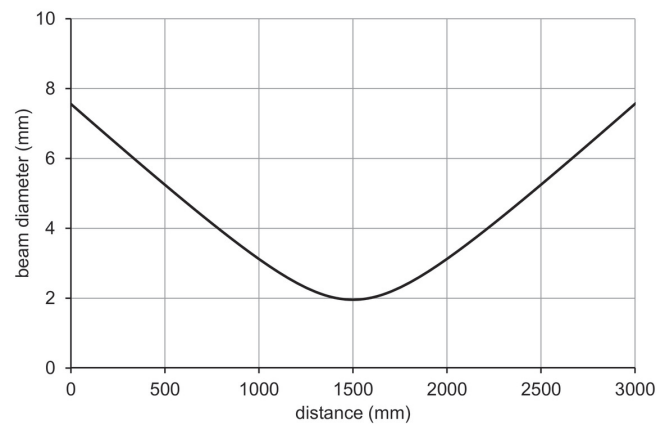

Laser warning

CLASS 1 LASER PRODUCT

IEC 60825-1/2014
Complies with 21 CFR 1040.10 and 1040.11 except for conformance with IEC 60825-1 Ed. 3., as described in Laser Notice No. 56, dated May 8, 2019

Connection diagram

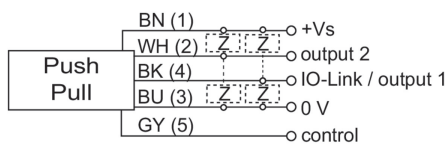

Repeat accuracy

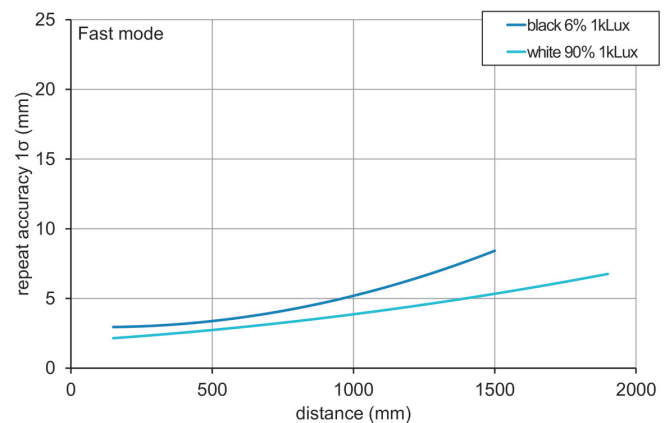

Repeat accuracy

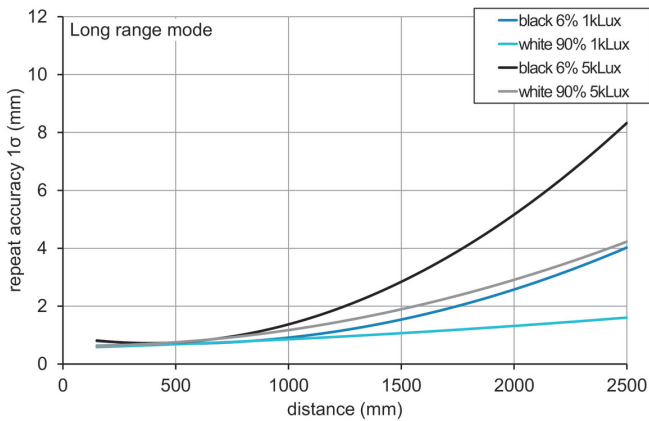
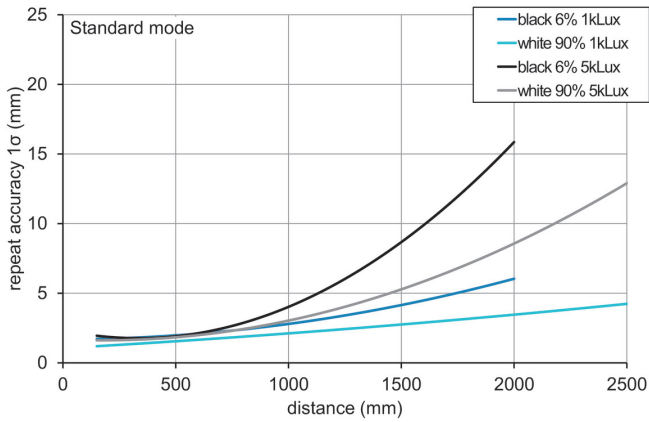

Hysteresis curve

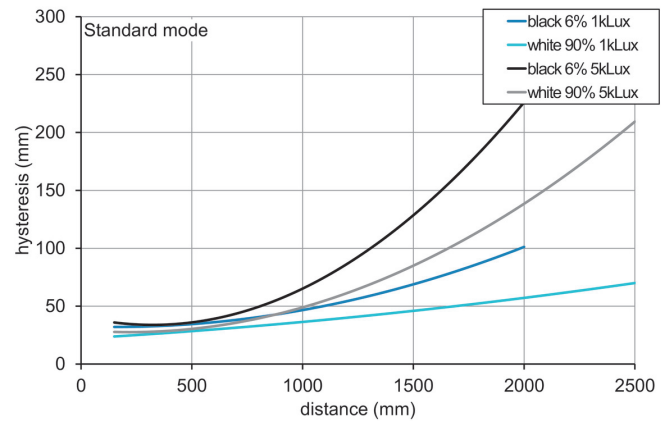
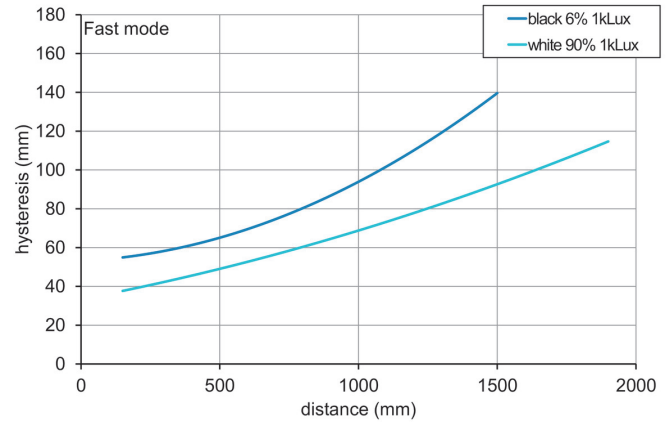

Sensing distance diagram

