

### General Description

The MDS5652 uses advanced Magnachip's MOSFET Technology, which provides low on-state resistance, high switching performance and excellent reliability.

### Features

- $V_{DS} = 30V$
- $I_D = 7.5A$  @  $V_{GS} = 10V$
- $R_{DS(ON)} < 22m\Omega$  @  $V_{GS} = 10V$   
 $< 35m\Omega$  @  $V_{GS} = 4.5V$

### Applications

- Portable Equipment Applications
- DC-DC Converter applications
- General purpose applications

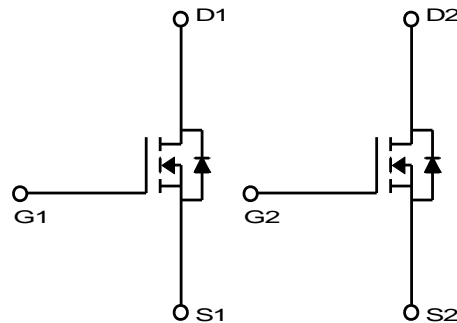
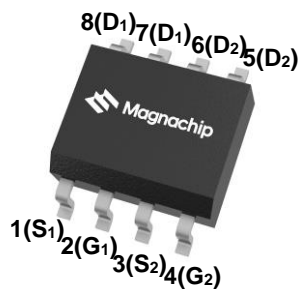

### Absolute Maximum Ratings ( $T_a = 25^\circ C$ unless otherwise noted)

Characteristics		Symbol	Rating	Unit
Drain-Source Voltage		$V_{DSS}$	30	V
Gate-Source Voltage		$V_{GSS}$	$\pm 20$	V
Continuous Drain Current	$T_a = 25^\circ C$	$I_D$	7.5	A
	$T_a = 100^\circ C$		4.8	A
Pulsed Drain Current		$I_{DM}$	30	A
Power Dissipation <sup>(1)</sup>	$T_a = 25^\circ C$	$P_D$	2.0	W
	$T_a = 100^\circ C$		0.8	
Single Pulse Avalanche Energy <sup>(2)</sup>		$E_{AS}$	12	mJ
Junction and Storage Temperature Range		$T_J, T_{stg}$	-55~+150	$^\circ C$

### Thermal Characteristics

Characteristics	Symbol	Rating	Unit
Thermal Resistance, Junction-to-Ambient(Steady-State) <sup>(1)</sup>	$R_{\theta JA}$	62.5	$^\circ C/W$
Thermal Resistance, Junction-to-Case	$R_{\theta JC}$	50	

## Ordering Information

Part Number	Temp. Range	Package	Packing	RoHS Status
MDS5652URH	-55~150°C	SOIC-8	Tape & Reel	Halogen Free

## Electrical Characteristics (T<sub>J</sub> = 25°C unless otherwise noted)

Characteristics	Symbol	Test Condition	Min	Typ	Max	Unit
<b>Static Characteristics</b>						
Drain-Source Breakdown Voltage	BV <sub>DSS</sub>	I <sub>D</sub> = 250μA, V <sub>GS</sub> = 0V	30	-	-	V
Zero Gate Voltage Drain Current	I <sub>DSS</sub>	V <sub>DS</sub> = 24V, V <sub>GS</sub> = 0V			1	μA
Gate to Source Leakage Current	I <sub>GSS</sub>	V <sub>GS</sub> = ±20V, V <sub>DS</sub> = 0V	-	-	100	nA
Gate to Source Threshold Voltage	V <sub>GS(th)</sub>	V <sub>DS</sub> = V <sub>GS</sub> , I <sub>D</sub> = 250μA	1	1.9	3	V
Static Drain to Source On Resistance	R <sub>DS(on)</sub>	V <sub>GS</sub> = 10V, I <sub>D</sub> = 7.5A	-	16	22	mΩ
		V <sub>GS</sub> = 4.5V, I <sub>D</sub> = 5.0A		23	35	
Forward Transconductance	g <sub>FS</sub>	V <sub>DS</sub> = 5V, I <sub>D</sub> = 7.5A		25	-	S
<b>Dynamic Characteristics</b>						
Total Gate Charge	Q <sub>g(10V)</sub>	V <sub>DD</sub> = 30V, I <sub>D</sub> = 7.5A, V <sub>GS</sub> = 10V	-	11.7	-	nC
Total Gate Charge	Q <sub>g(4.5V)</sub>			6.1		
Gate to Source Charge	Q <sub>gs</sub>			2.1	-	
Gate to Drain Charge	Q <sub>gd</sub>			3.2	-	
Input Capacitance	C <sub>iss</sub>	V <sub>DS</sub> = 30V, V <sub>GS</sub> = 0V, f = 1.0MHz	-	460	-	pF
Reverse Transfer Capacitance	C <sub>rss</sub>			58	-	
Output Capacitance	C <sub>oss</sub>			154	-	
Turn-On Delay Time	t <sub>d(on)</sub>	V <sub>GS</sub> = 10V, V <sub>DD</sub> = 15V, R <sub>L</sub> = 2.1Ω, R <sub>GEN</sub> = 3Ω	-	3.8	-	ns
Turn-On Rise Time	t <sub>r</sub>			24.6	-	
Turn-Off Delay Time	t <sub>d(off)</sub>			17.4	-	
Turn-Off Fall Time	t <sub>f</sub>			10.6	-	
<b>Drain-Source Body Diode Characteristics</b>						
Source-Drain Diode Forward Voltage	V <sub>SD</sub>	I <sub>S</sub> = 1A, V <sub>GS</sub> = 0V	-	0.75		V
Body Diode Reverse Recovery Time	t <sub>rr</sub>	I <sub>F</sub> = 7.5A, di/dt = 100A/μs	-	16	-	ns
Body Diode Reverse Recovery Charge	Q <sub>rr</sub>			-	7.5	-

Note :

- Surface mounted FR-4 board with 2oz. Copper.
- Starting T<sub>J</sub> = 25°C, L = 1mH, I<sub>AS</sub> = 5A, V<sub>DD</sub> = 15V, V<sub>GS</sub> = 10V

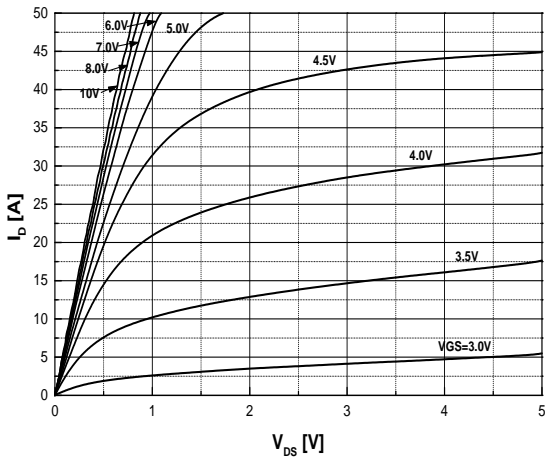

**Fig.1 On-Region Characteristics**

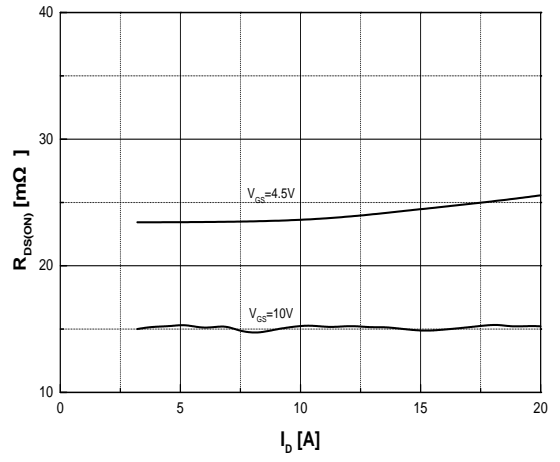

**Fig.2 On-Resistance Variation with Drain Current and Gate Voltage**

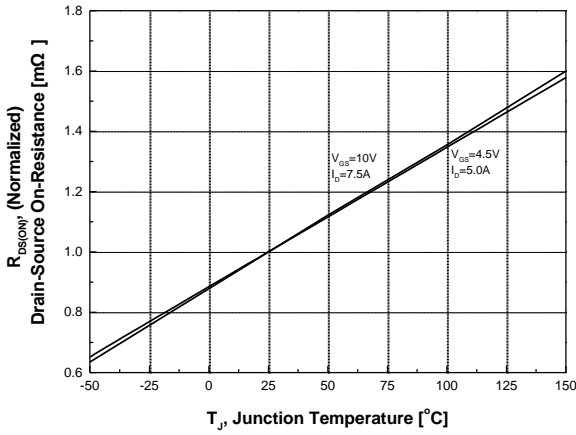

**Fig.3 On-Resistance Variation with Temperature**

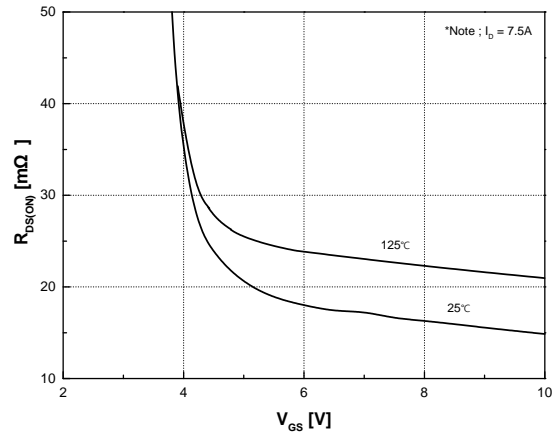

**Fig.4 On-Resistance Variation with Gate to Source Voltage**

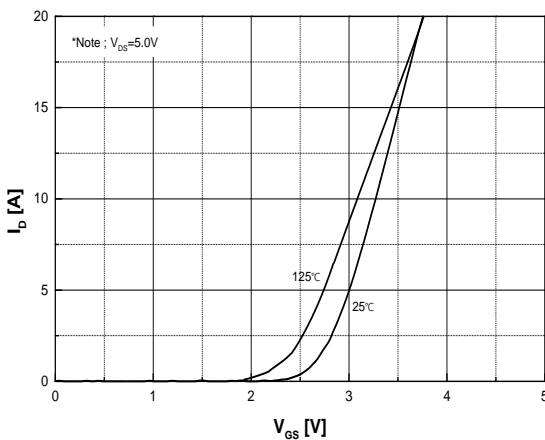

**Fig.5 Transfer Characteristics**

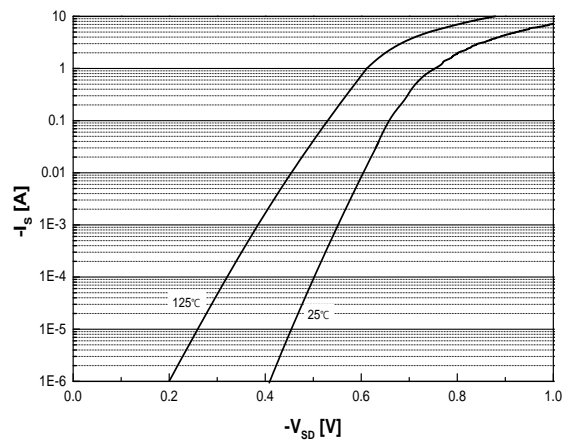

**Fig.6 Body Diode Forward Voltage Variation with Source Current and Temperature**

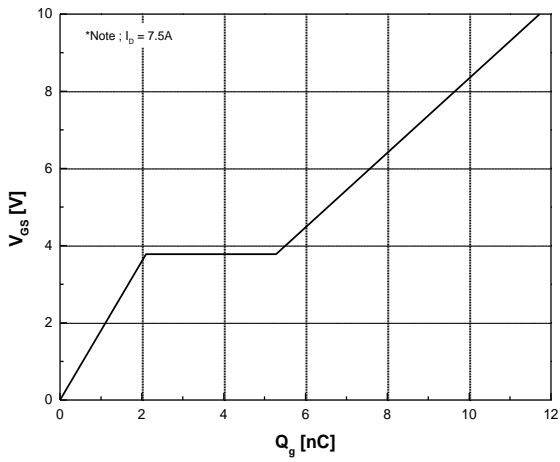

**Fig.7 Gate Charge Characteristics**

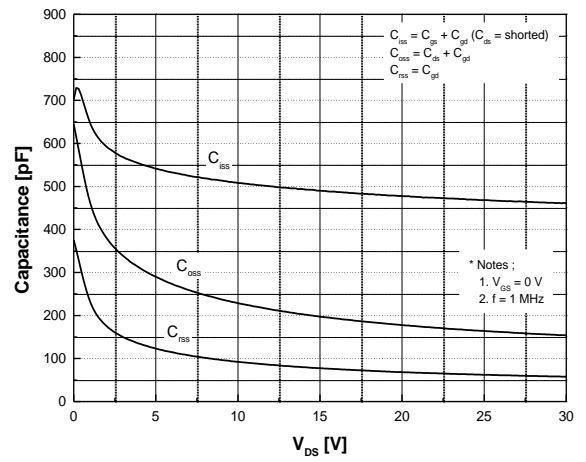

**Fig.8 Capacitance Characteristics**

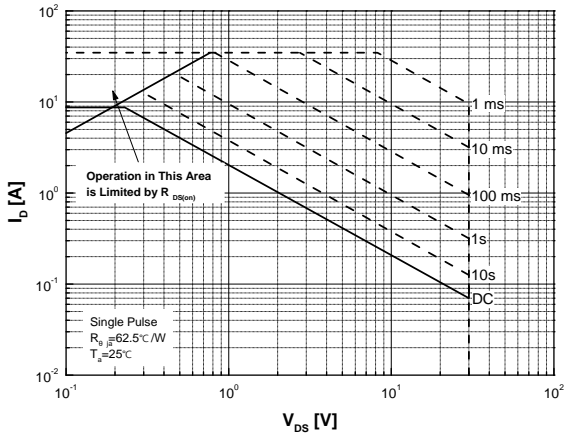

**Fig.9 Maximum Safe Operating Area**

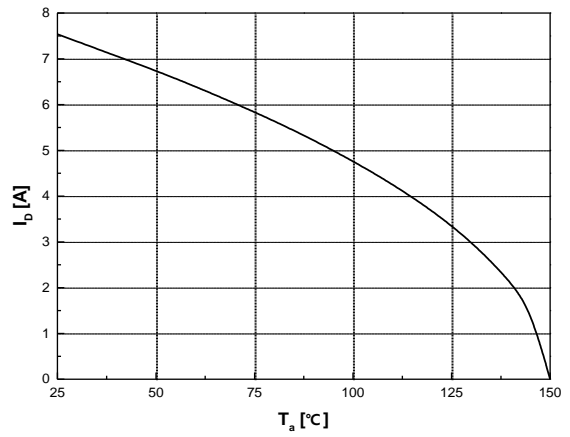

**Fig.10 Maximum Drain Current Vs. Ambient Temperature**

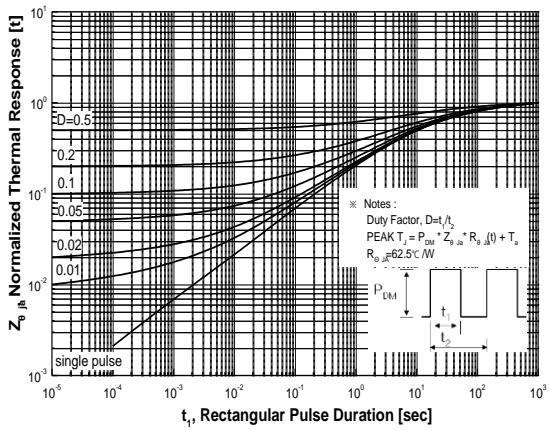
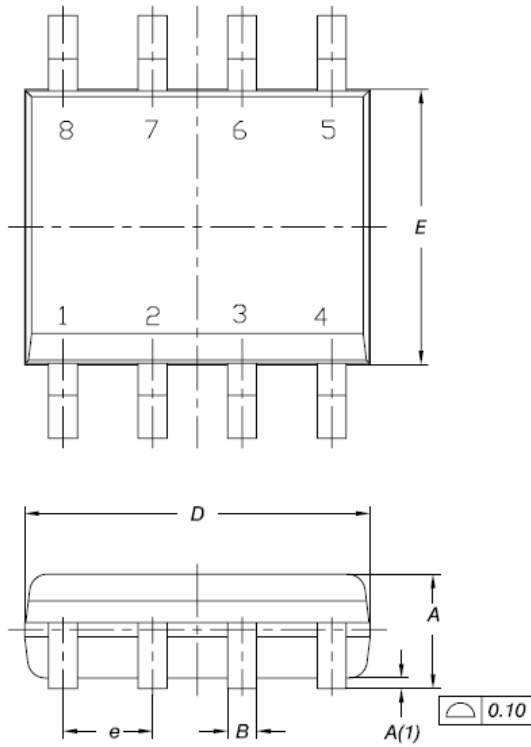

**Fig.11 Transient Thermal Response Curve**

## Physical Dimensions

### SOIC-8L

Dimensions are in millimeters unless otherwise specified



DIM.	MILLIMETERS		
	MIN.	NOM.	MAX.
A	1.35	1.55	1.75
A(1)	0.10	0.175	0.25
B	0.38	0.445	0.51
C	0.19	0.22	0.25
D	4.80	4.90	5.00
E	3.80	3.90	4.00
e	1.27 BSC		
H	5.80	6.00	6.20
L	0.50	0.715	0.93
$\alpha$	0°	4°	8°
h	0.25	0.375	0.50

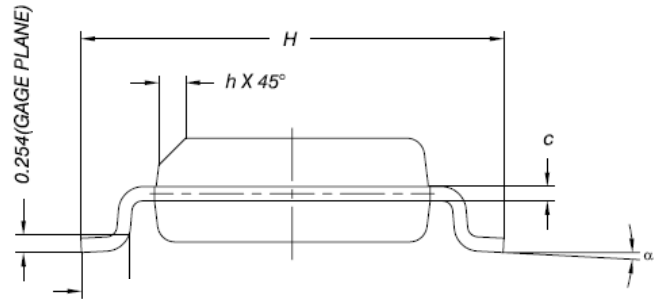

Note : Package body size, length and width do not include mold flash, protrusions and gate burrs.

**DISCLAIMER:**

The Products are not designed for use in hostile environments, including, without limitation, aircraft, nuclear power generation, medical appliances, and devices or systems in which malfunction of any Product can reasonably be expected to result in a personal injury. Seller's customers using or selling Seller's products for use in such applications do so at their own risk and agree to fully defend and indemnify Seller.

Magnachip reserves the right to change the specifications and circuitry without notice at any time. Magnachip does not consider responsibility for use of any circuitry other than circuitry entirely included in a Magnachip product.  Magnachip is a registered trademark of Magnachip Semiconductor Ltd.