



MICRO SWITCH
Military-Grade Toggle Switches
TL Series



Datasheet

MICRO SWITCH TL Series Toggle Switches

Honeywell MICRO SWITCH TL Series toggle switches are military qualified to MIL-DTL-3950, specifications for sealed toggle switches. Quality construction features include a bonded seal between the toggle lever and bushing, and between the cover and case.

The robust design of the TL Series toggle is well-suited for many military, aerospace and other demanding applications where reliability is essential. These applications include environments where the panels are subjected to mechanical shock, vibration, and temperature extremes as well as environments with dust, splashing or hose-directed water.

TL Series toggle switches offer a variety of circuitry and pole options to easily integrate into a number of applications. A long history in military and aerospace applications has shown the TL Series toggle provides reliable performance with long operating life under the toughest conditions.

What makes our switches better?

- MIL-DTL-3950 qualified switches available to meet military specifications
- Environmental sealing enables switches to withstand many demanding indoor and outdoor applications
- 1-, 2-, and 4-pole options for a variety of circuitry requirements
- 2- and 3-position, maintained and momentary toggle action to meet circuit and actuator requirements
- UL recognized, CSA certified, and CE approved for global use



***ATTENTION!!
TL Series toggles are qualified
for military duty!***

MILITARY QUALIFIED • GLOBAL APPROVALS
MULTI-CIRCUITS • HIGH PERFORMANCE

Features and Benefits

MIL-QUALIFIED AND GLOBAL APPROVALS

MIL-DTL-3950 qualified switches are available to meet military/aerospace specifications. TL Series toggles' environmental sealing enables switches to withstand many demanding indoor and outdoor applications. Quality construction includes a bonded seal between the toggle lever and bushing, and between the cover and case that enables switches to **withstand may demanding conditions**. UL recognized, CSA certified, and CE approved for global use

Military-qualified listings

VARIETY OF CIRCUITRIES AND OPERATING ACTIONS

TL Series' **1, 2, and 4 pole options** meet a variety of circuitry requirements; while **2- and 3-position, maintained and momentary** toggle action, for a breadth of circuitry and actuator requirements. They thrive in a wide range of temperatures: -65 °C to 71 °C [-85 °F to 160 °F]

Locking levers reduce unintended actuation

LOCKING LEVERS

Optional **lever locks** (pull-to-unlock) require two separate actions to actuate the switch in order to prevent unintended actuation

MULTIPLE CONNECTION OPTIONS

MICRO SWITCH TL Series toggles offer **three popular termination options**: screw, solder lugs, and IWTS (Integrated Wire Termination Systems)

EASILY CONTROLS LOW-VOLTAGE DC APPLICATIONS

Toggle switches available with a choice of **silver alloy or gold-plated contacts** to handle a variety of electrical load requirements

INNOVATIVE PRODUCT DESIGN

Engineered step-design case provides added space between terminals to **prevent shorting**

ROBUST CONSTRUCTION

Built from **military-grade components** to achieve MIL-DTL-3950 requirements

Potential Applications



MILITARY AND COMMERCIAL AIRCRAFT AND HELICOPTERS

Used in fixed wing aircraft and helicopter flight decks. Honeywell has a long history of providing TL Series toggle switches in commercial and military aircraft.

AVIATION GROUND SUPPORT EQUIPMENT

Used to turn on and operate various components of aviation ground support equipment, such as pumps, lights, and lift platforms.



MILITARY LAND VEHICLES (TRACK AND WHEELED VEHICLES)

Used in military land vehicles to control lights, pumps, arming equipment, and movement control of lifts/ramps, etc.

CONSTRUCTION EQUIPMENT

Often used on road milling, road pavers, trenchers, and stump cutters to operate movement of machinery and/or turn on lights, pumps, etc.



MICRO SWITCH™ Military-Grade Toggle Switches

Table 1. Specifications

| Characteristic | Parameter |
|-----------------------|-----------------------------------------------------------------------|
| Description | military-grade toggle switch |
| Sealing | qualified to MIL-DTL-3950 |
| Operating temperature | -65 °C to 71 °C [-85 °F to 160 °F] |
| Actuators | standard, locking, special design, tab |
| Action | 2- or 3- position; momentary and maintained |
| Mounting | Bushing 15/32 in (0.47 in) Ø |
| Circuitry | SPST, SPDT, DPST, DPDT, 4PST, 4PDT |
| Terminations | IWTS, solder, screw, quick-connect, leadwire |
| Contacts | Silver alloy or gold-plated |
| Amp rating | Up to 20 A, ac and dc capability |
| Approvals | UL, CSA, CE |
| Measurement | 26,7 mm H x 33,5 mm W x 22,6 mm D [1.05 in H x 1.32 in W x 0.89 in D] |

Table 2. UL and CSA Electrical Ratings

| Rating code | Electrical rating |
|-------------|------------------------------------------------------------------------------------|
| L192 | 10 amps, 125, 250, 277 Vac; ¼ Hp, 125 Vac; ½ Hp, 250, 277 Vac; 3 amps, 125 Vac “L” |
| L191 | 15 amps, 125, 250, 277 Vac; ½ Hp, 125 Vac; 1 Hp, 250, 277 Vac; 5 amps, 125 Vac “L” |

Table 3. Electrical Ratings (in amperes)

| Electrical rating code | 28 Vdc | | | 115 Vdc | 250 Vdc | 115 Vac, 60 Hz & 400 Hz Max. | | | 230 Vac |
|------------------------|--------|------|------|---------|---------|------------------------------|------|------|---------|
| | Ind. | Res. | Lamp | Res. | Res. | Ind. | Res. | Lamp | Res. |
| 1 | 15 | 20 | 5 | 0.75 | 0.5 | 10 | 15 | 3 | 6 |
| 2 | 10 | 15 | 4 | 0.75 | 0.5 | 7 | 15 | 2 | 6 |
| 3 | 15 | 20 | 7 | 0.75 | 0.5 | 15 | 15 | 4 | 6 |
| 4 | 10 | 18 | 5 | 0.75 | 0.5 | 8 | 11 | 2 | 6 |
| 5 | 12 | 20 | 5 | 0.75 | 0.5 | 15 | 15 | 4 | 6 |
| 6 | 10 | 18 | 4 | 0.75 | 0.5 | 8 | 11 | 2 | 6 |

TL Series

TERMINAL CIRCUIT IDENTIFICATION

Terminal identifications are referred to in the order guides to indicate which circuits are made in each toggle position (i.e., 1-2 refers to circuit closure through terminals 1 and 2).

One Pole

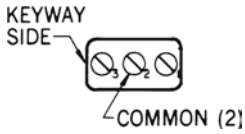

Two Pole

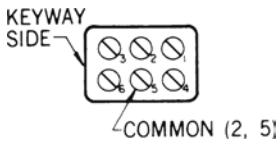

Four Pole

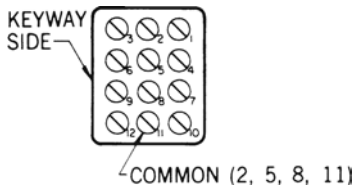

TERMINALS

In addition to the screw terminal listings in the order guides, IWTS (Integrated Wire Termination Systems) versions and solder current terminals are available.

IWTS provides a reliable, completely serviceable unit which meets MIL-DTL-3950 requirements. IWTS improves maintainability since wiring bundles need not be disturbed. Leads are quickly and easily assembled or removed with an insert-extract tool.

A unique three-rib (grommet style) elastomer seal protects the lead connections without potting. There are no exposed metal terminals.

Versions available that will accept No. 16 wire with M39029/1-102 contact pins or No. 20 wire with MS39029/1-101 contact pins. Connections are resistant to shock, vibration, and high pull-out force.

SPECIAL CIRCUITRIES

Catalog listings with -10, -50, and -70 suffix numbers, as shown in the order guides, have special "on-on-on" circuits, as illustrated below. TLs with -12 suffix are the same as -50 except the keyway position is maintained, and the center position circuits 2-3 and 4-5 are made. -72 is the same as -50 except that the opposite keyway position is momentary, and in the center position circuits 2-3 and 4-5 are made.

-10 CIRCUITRY

| No of poles | Keyway Side Maint. Position | Center Maint. Position | Opposite Keyway Maint. Position |
|-------------|-----------------------------|------------------------|---------------------------------|
| 2 | | | |
| 4 | | | |

-50 CIRCUITRY

| No of poles | Keyway Side Maint. Position | Center Maint. Position | Opposite Keyway Maint. Position |
|-------------|-----------------------------|------------------------|---------------------------------|
| 2 | | | |
| 4 | | | |

-70 CIRCUITRY

| No of poles | Keyway Side Maint. Position | Center Maint. Position | Opposite Keyway Maint. Position |
|-------------|-----------------------------|------------------------|---------------------------------|
| 2 | | | |
| 4 | | | |

MICRO SWITCH™ Military-Grade Toggle Switches

TL (SCREW TERMINAL) 2-POSITION ORDER GUIDE

| No. of poles | Circuits Made with Toggle At: | | | | Standard Toggle | | Pull-to-Unlock Toggle | |
|--------------|-------------------------------|----------------------|--------------------|----------------|-----------------|-----------------|----------------------------------------------------|-------------------|
| | Keyway Position | Opposite Keyway | Elect. Rating Code | UL Rating Code | Catalog Listing | Military Number | Add Suffix to Standard Toggle Listing ^Δ | Military Number** |
| 1 | OFF | 2-3 | 1 | L191 | 1TL1-2 | MS24523-22 | D, F, G | MS24658-22 |
| | OFF* | 2-3 | 2 | L192 | 1TL1-4 | MS24523-29 | F | MS24658-29 |
| | 1-2* | OFF | 2 | L192 | 1TL1-6 | MS24523-30 | F | MS24658-30 |
| | 1-2 | 2-3 | 1 | L191 | 1TL1-3 | MS24523-23 | D, F, G | MS24658-23 |
| | 1-2* | 2-3 | 2 | L192 | 1TL1-8 | MS24523-26 | F | MS24658-26 |
| 2 | OFF | 2-3, 5-6 | 3 | L191 | 2TL1-2 | MS24524-22 | D, F, G | MS24659-22 |
| | OFF* | 2-3, 5-6 | 4 | L192 | 2TL1-4 | MS24524-29 | F | MS24659-29 |
| | 1-2, 4-5* | OFF | 4 | L192 | 2TL1-6 | MS24524-30 | F | MS24659-30 |
| | 1-2, 4-5 | 2-3, 5-6 | 3 | L191 | 2TL1-3 | MS24524-23 | D, F, G | MS24659-23 |
| | 1-2, 4-5* | 2-3, 5-6 | 4 | L192 | 2TL1-8 | MS24524-26 | F | MS24659-26 |
| 4 | OFF | 2-3, 5-6, 8-9, 11-12 | 5 | L191 | 4TL1-2 | MS24525-22 | D, F, G | MS24660-22 |
| | OFF* | 2-3, 5-6, 8-9, 11-12 | 6 | L192 | 4TL1-4 | MS24525-29 | F | MS24660-29 |
| | 1-2, 4-5, 7-8, 10-11* | OFF | 6 | L192 | 4TL1-6 | MS24525-30 | F | MS24660-30 |
| | 1-2, 4-5, 7-8, 10-11 | 2-3, 5-6, 8-9, 11-12 | 5 | L191 | 4TL1-3 | MS24525-23 | D, F, G | MS24660-23 |
| | 1-2, 4-5*, 7-8, 10-11 | 2-3, 5-6, 8-9, 11-12 | 6 | L192 | 4TL1-8 | MS24525-26 | F | MS24660-26 |

* These positions are momentary. All others are maintained.

** Also add the appropriate suffix to the military number.

^Δ See page 12 for locking configurations.

PULL-TO-UNLOCK OPTION

When ordering pull-to-unlock toggle listings (see page 12 for configurations), add the suffix letter shown in the chart on page XXX to the standard toggle listing or the MS part number. For example, to order a 1TL1-1 pull-to-unlock toggle switch with the lever locked in the center position, add the letter **E** (i.e., 1TL1-1**E**, MS24658-21**E**)



SOLDER TURRET TERMINAL VERSION

11TL, 12TL, and 14TL type switches with solder current terminals are qualified to MIL-DTL-3950. They have the same circuitry and electrical ratings as their 1TL, 2TL, and 4TL counterparts. For example, an 11TL1-2 is the same as a 1TL1-2, except it has solder turret terminals instead of screw terminals.

| Circuitry | Type | Standard Lever | Lever Lock |
|-----------|------|----------------|------------|
| One pole | 11TL | MS27734 | MS27737 |
| Two pole | 12TL | MS27735 | MS27738 |
| Four pole | 14TL | MS27736 | MS27739 |

TL Series

TL (SCREW TERMINAL) 3-POSITION ORDER GUIDE

| No. of poles | Circuits Made with Toggle At: | | | | | Standard Toggle | | Pull-to-Unlock Toggle | |
|-----------------------|-------------------------------|-----------------------|-----------------------|--------------------|--------------------|-----------------|-----------------|----------------------------------------------------|--------------------------------|
| | Keyway Position | Center Position | Opposite Keyway | Elect. Rating Code | UL/CSA Rating Code | Catalog Listing | Military Number | Add Suffix to Standard Toggle Listing ^Δ | Military Number ^{***} |
| 1 | 1-2 | OFF | 2-3 | 1 | L191 | 1TL1-1 | MS24523-21 | ALL TYPES | MS24658-21 |
| | 1-2* | OFF | 2-3 | 2 | L192 | 1TL1-5 | MS24523-31 | E, F, K, L, M, N | MS24658-31 |
| | 1-2* | OFF | 2-3* | 2 | L192 | 1TL1-7 | MS24523-27 | E, L, N | MS24658-27 |
| | NONE** | OFF | 2-3 | 1 | L191 | 1TL1-21 | MS24523-24 | E, F, K, M | MS24658-24 |
| | NONE** | 1-2 | 2-3 | 1 | L192 | 1TL1-31 | MS24523-33 | E, F, K, M | MS24658-33 |
| | NONE** | 1-2 | 2-3* | 2 | L192 | 1TL1-51 | MS24523-32 | E | MS24658-32 |
| | 1-2* | OFF | NONE** | 2 | L192 | 1TL1-61 | MS24523-28 | E | MS24658-28 |
| 2 | 1-2, 4-5 | OFF | 2-3, 5-6 | 3 | L191 | 2TL1-1 | MS24524-21 | ALL TYPES | MS24659-21 |
| | 1-2, 4-5* | OFF | 2-3, 5-6 | 4 | L192 | 2TL1-5 | MS24524-31 | E, F, K, L, M, N | MS24659-31 |
| | 1-2, 4-5* | OFF | 2-3, 5-6* | 4 | L192 | 2TL1-7 | MS24524-27 | E, L, N | MS24659-27 |
| | NONE** | OFF | 2-3, 5-6 | 3 | L191 | 2TL1-21 | MS24524-24 | E, F, K, M | MS24659-24 |
| | NONE** | 1-2, 4-5 | 2-3, 5-6 | 3 | L191 | 2TL1-31 | MS24524-33 | E, F, K, M | MS24659-33 |
| | NONE** | 1-2, 4-5 | 2-3, 5-6* | 4 | L192 | 2TL1-51 | MS24524-32 | E | MS24659-32 |
| | 1-2, 4-5* | OFF | NONE** | 4 | L192 | 2TL1-61 | MS24524-28 | E | MS24659-28 |
| | 1-2, 4-5 | 1-2, 5-6 | 2-3, 5-6 | 3 | L191 | 2TL1-10 | MS27407-4 | ALL TYPES | MS27408-4 |
| | 1-2, 4-5* | 1-2, 5-6 | 2-3, 5-6 | 4 | L192 | 2TL1-50 | MS27407-5 | E, F, K, L, M, N | MS27408-5 |
| 1-2, 4-5* | 1-2, 5-6 | 2-3, 5-6* | 4 | L192 | 2TL1-70 | MS27407-6 | E, L, N | MS27408-6 | |
| 4 | 1-2, 4-5, 7-8, 10-11 | OFF | 2-3, 5-6, 8-9, 11-12 | 5 | L191 | 4TL1-1 | MS24525-21 | ALL TYPES | MS24660-21 |
| | 1-2, 4-5, 7-8, 10-11* | OFF | 2-3, 5-6, 8-9, 11-12 | 6 | L192 | 4TL1-5 | MS24525-31 | E, F, K, L, M, N | MS24660-31 |
| | 1-2, 4-5, 7-8, 10-11* | OFF | 2-3, 5-6, 8-9, 11-12* | 6 | L192 | 4TL1-7 | MS24525-27 | E, L, N | MS24660-27 |
| | NONE** | OFF | 2-3, 5-6, 8-9, 11-12 | 5 | L191 | 4TL1-21 | MS24525-24 | E, F, K, M | MS24660-24 |
| | NONE** | 1-2, 4-5, 7-8, 10-11 | 2-3, 5-6, 8-9, 11-12 | 5 | L191 | 4TL1-31 | MS24525-33 | E, F, K, M | MS24660-33 |
| | NONE** | 1-2, 4-5, 7-8, 10-11 | 2-3, 5-6, 8-9, 11-12* | 6 | L192 | 4TL1-51 | MS24525-32 | E | MS24660-32 |
| | 1-2, 4-5, 7-8, 10-11* | OFF | NONE** | 6 | L192 | 4TL1-61 | MS24525-38 | E | MS24660-28 |
| | 1-2, 4-5, 7-8, 10-11 | 2-3, 4-5 | 2-3, 5-6, 8-9, 11-12 | 5 | L191 | 4TL1-10 | - | ALL TYPES | - |
| | 1-2, 4-5, 7-8, 10-11* | 2-3, 4-5, 7-8, 11-12 | 2-3, 5-6, 8-9, 11-12 | 6 | L192 | 4TL1-50 | MS27406-2 | E, F, K, L, M, N | MS27409-2 |
| | 1-2, 4-5, 7-8, 10-11* | 2-3, 4-5 | 2-3, 5-6, 8-9, 11-12* | 6 | L192 | 4TL1-70 | - | E, L, N | - |
| | 1-2, 4-5, 7-8, 10-11 | 2-3, 4-5, 7-8, 11-12 | 2-3, 5-6, 8-9, 11-12 | 5 | L191 | 4TL1-12 | MS27406-1 | ALL TYPES | MS27409-1 |
| 1-2, 4-5, 7-8, 10-11* | 2-3, 4-5, 7-8, 11-12 | 2-3, 5-6, 8-9, 11-12* | 6 | L192 | 4TL1-72 | MS27406-3 | E, L, N | MS27409-3 | |

* These positions are momentary. All others are maintained.

** Toggle lever is blocked from these products. Toggle becomes 2-position, with center being one extreme position.

*** Also add appropriate suffix letter to military number

^Δ See page 12 for locking configurations.

MICRO SWITCH™ Military-Grade Toggle Switches

TL (IWTS TERMINATION) 2-POSITION ORDER GUIDE

| No. of poles | Circuits Made with Toggle At: | | | Elect. Rating Code | UL Rating Code | No. 16 Termination | | No. 20 Termination | |
|--------------|-------------------------------|----------------------|--|--------------------|----------------|--------------------|-----------------|--------------------|-----------------|
| | Keyway Position | Opposite Keyway | | | | Catalog Listing | Military Number | Catalog Listing | Military Number |
| 1 | OFF | 2-3 | | 1 | L191 | 101TL1-2 | MS27722-22 | 101TL2-2 | MS27784-22 |
| | OFF* | 2-3 | | 2 | L192 | 101TL1-4 | MS27722-29 | 101TL2-4 | MS27784-29 |
| | 1-2* | OFF | | 2 | L192 | 101TL1-6 | MS27722-30 | 101TL2-6 | MS27784-30 |
| | 1-2 | 2-3 | | 1 | L191 | 101TL1-3 | MS27722-23 | 101TL2-3 | MS27784-23 |
| | 1-2* | 2-3 | | 2 | L192 | 101TL1-8 | MS27722-26 | 101TL2-8 | MS27784-26 |
| 2 | OFF | 2-3, 5-6 | | 3 | L191 | 102TL1-2 | MS27723-22 | 102TL2-2 | MS27785-22 |
| | OFF* | 2-3, 5-6 | | 4 | L192 | 102TL1-4 | MS27723-29 | 102TL2-4 | MS27785-29 |
| | 1-2, 4-5* | OFF | | 4 | L192 | 102TL1-6 | MS27723-30 | 102TL2-6 | MS27785-30 |
| | 1-2, 4-5 | 2-3, 5-6 | | 3 | L191 | 102TL1-3 | MS27723-23 | 102TL2-3 | MS27785-23 |
| | 1-2, 4-5* | 2-3, 5-6 | | 4 | L192 | 102TL1-8 | MS27723-26 | 102TL2-8 | MS27785-26 |
| 4 | OFF | 2-3, 5-6, 8-9, 11-12 | | 5 | L191 | 104TL1-2 | MS27724-22 | 104TL2-2 | MS27786-22 |
| | OFF* | 2-3, 5-6, 8-9, 11-12 | | 6 | L192 | 104TL1-4 | MS27724-29 | 104TL2-4 | MS27786-29 |
| | 1-2, 4-5, 7-8, 10-11* | OFF | | 6 | L192 | 104TL1-6 | MS27724-30 | 104TL2-6 | MS27786-30 |
| | 1-2, 4-5, 7-8, 10-11 | 2-3, 5-6, 8-9, 11-12 | | 5 | L191 | 104TL1-3 | MS27724-23 | 104TL2-3 | MS27786-23 |
| | 1-2, 4-5, 7-8, 10-11* | 2-3, 5-6, 8-9, 11-12 | | 6 | L192 | 104TL1-8 | MS27724-26 | 104TL2-8 | MS27786-26 |

TL (IWTS TERMINATION) 3-POSITION ORDER GUIDE

| No. of poles | Circuits Made with Toggle At: | | | | Elect. Rating Code | UL/CSA Rating Code | No. 16 Termination | | No. 20 Termination | |
|--------------|-------------------------------|-----------------|-----------------------|--|--------------------|--------------------|--------------------|-----------------|--------------------|-----------------|
| | Keyway Position | Center Position | Opposite Keyway | | | | Catalog Listing | Military Number | Catalog Listing | Military Number |
| 1 | 1-2 | OFF | 2-3 | | 1 | L191 | 101TL1-1 | MS27722-21 | 101TL2-1 | MS27784-21 |
| | 1-2* | OFF | 2-3 | | 2 | L192 | 101TL1-5 | MS27722-31 | 101TL2-5 | MS27784-31 |
| | 1-2* | OFF | 2-3* | | 2 | L192 | 101TL1-7 | MS27722-27 | 101TL2-7 | MS27784-27 |
| 2 | 1-2, 4-5 | OFF | 2-3, 5-6 | | 3 | L191 | 102TL1-1 | MS27723-21 | 102TL2-1 | MS27785-21 |
| | 1-2, 4-5* | OFF | 2-3, 5-6 | | 4 | L192 | 102TL1-5 | MS27723-31 | 102TL2-5 | MS27785-31 |
| | 1-2, 4-5* | OFF | 2-3, 5-6* | | 4 | L192 | 102TL1-7 | MS27723-6 | 102TL2-7 | MS27785-27 |
| 4 | 1-2, 4-5, 7-8, 10-11 | OFF | 2-3, 5-6, 8-9, 11-12 | | 5 | L191 | 104TL1-1 | MS27724-21 | 104TL2-1 | MS27786-21 |
| | 1-2, 4-5, 7-8, 10-11* | OFF | 2-3, 5-6, 8-9, 11-12 | | 6 | L192 | 104TL1-5 | MS27724-31 | 104TL2-5 | MS27786-31 |
| | 1-2, 4-5, 7-8, 10-11* | OFF | 2-3, 5-6, 8-9, 11-12* | | 6 | L192 | 104TL1-7 | MS27724-27 | 104TL2-7 | MS27786-27 |

* These positions are momentary. All others are maintained.

NOTE: For TL switches featuring IWTS termination and a "pull-to-unlock" lever option, contact a Honeywell Sensing and Control representative at 1-800-537-6945.

TL Series

TL SERIES 1-POLE STANDARD ACTUATOR OPTIONS, TERMINALS, & DIMENSIONS

Note: Three-position switches shown

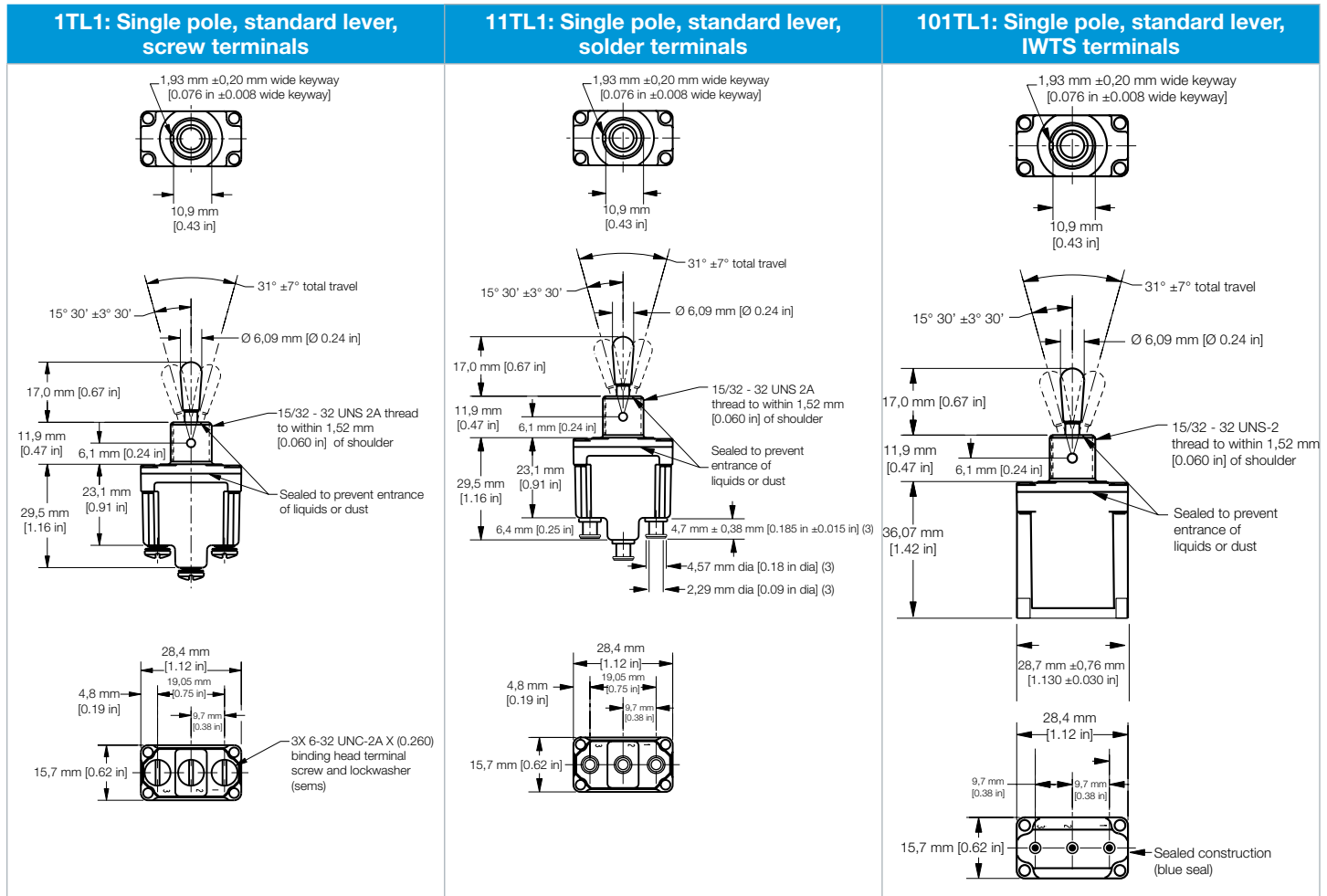

Locking lever dimensions for single pole TL toggles

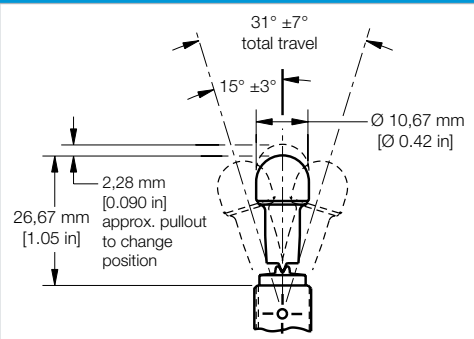

MICRO SWITCH™ Military-Grade Toggle Switches

TL SERIES 2-POLE STANDARD ACTUATOR OPTIONS, TERMINALS, & DIMENSIONS

Note: Three-position switches shown

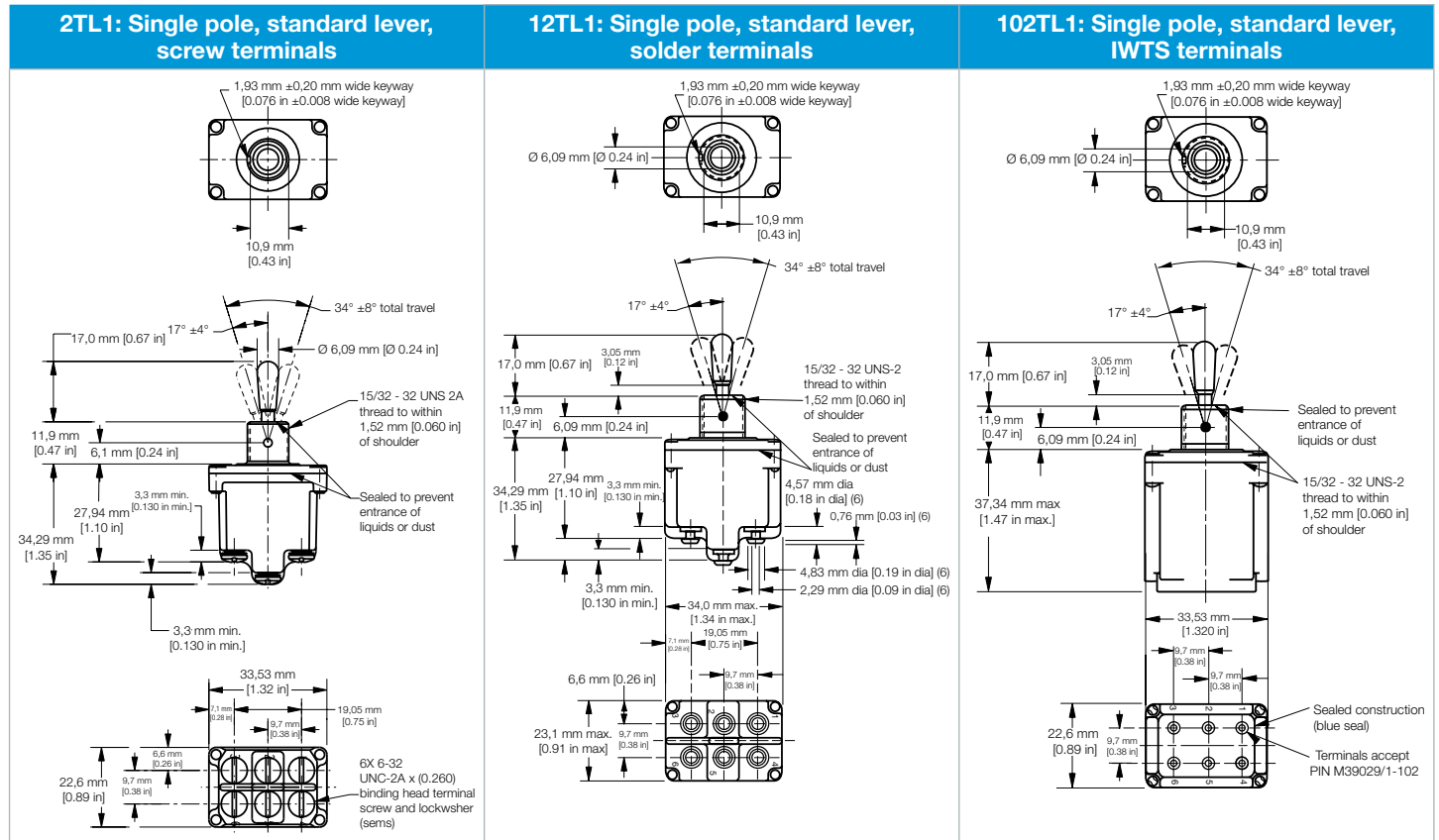

Locking lever dimensions for double pole TL toggles

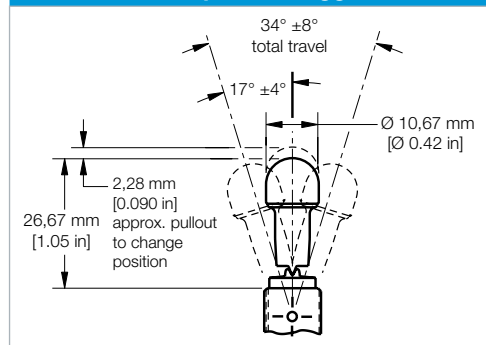





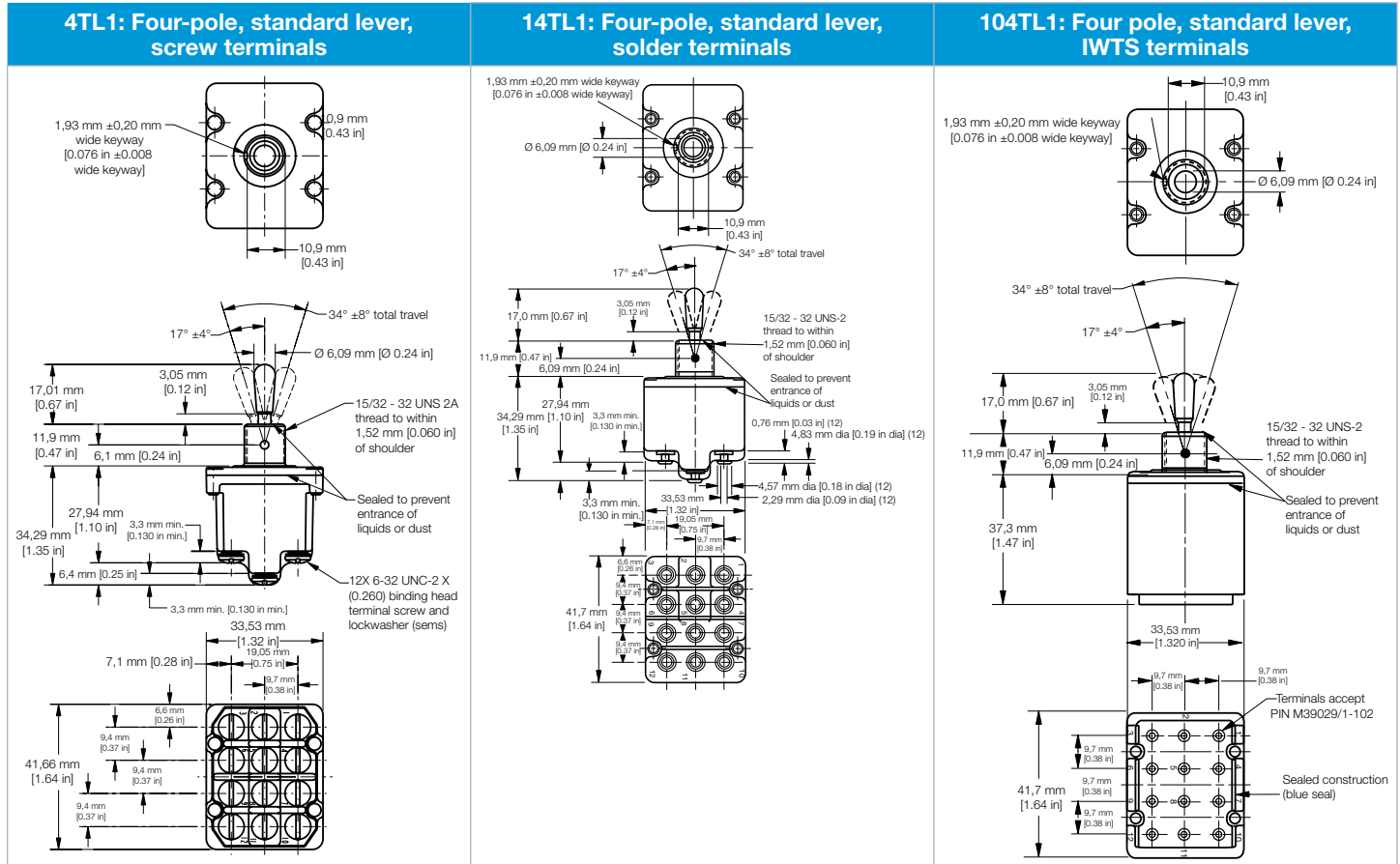







TL SERIES 4-POLE STANDARD ACTUATOR OPTIONS, TERMINALS, & DIMENSIONS

Note: Three-position switches shown



MICRO SWITCH™ Military-Grade Toggle Switches

MICRO SWITCH™ TL™ SERIES LOCKING CONFIGURATIONS

| | | | | | | |
|----------------------------------------------------------------------------------------------------------------------------------------------------------------------------------|------------------------------------------------------------------------------------------------------------------------------------------------------------------------------|---------------------------------------------------------------------------------------------------------------------------------------------------------------|--------------------------------------------------------------------------------------------------------------------------------------------------------------------------------|---------------------------------------------------------------------------------------------------------------------------------------------------------------------|------------------------------------------------------------------------------------------------------------------------------------------------------------------------------|--------------------------------------------------------------------------------------------------------------------------------------------------------------------------------|
| <p>A</p>  <p>Locked In Three Positions</p> | <p>B</p>  <p>Locked In Center and Extreme Position (Keyway Side)</p> | <p>D</p>  <p>Locked Out Of Center Position</p> | <p>E</p>  <p>Locked In Center Position</p> | <p>F</p>  <p>Locked In Extreme Position (Opposite Keyway)</p> | <p>G</p>  <p>Locked In Extreme Position (Keyway Side)</p> | <p>H</p>  <p>Locked Out Of Center And Extreme Position (Keyway Side)</p> |
| <p>J</p>  <p>Locked Out Of Center And Extreme Position (Opposite Keyway)</p> | <p>K</p>  <p>Locked In Center And Extreme Position (Opposite Keyway)</p> | <p>L</p>  <p>Locked Out Of Extreme Position (Keyway Side)</p> | <p>M</p>  <p>Locked Out Of And Into Extreme Position (Opposite Keyway)</p> | <p>N</p>  <p>Locked Out Of Extreme Position (Opposite Keyway)</p> | <p>P</p>  <p>Locked Out Of And Into Extreme Position (Keyway Side)</p> | |

ADDITIONAL INFORMATION

The following associated literature is available on the Web (sensing.honeywell.com):

- Product installation instructions
- Product range guide
- Product application-specific information
 - Flight deck toggle switches
 - Sensors and switches in front loaders
 - Sensors and switches in mobile cranes
 - Sensors and switches in oil rig applications

For more information

Honeywell Sensing and Internet of Things services its customers through a worldwide network of sales offices and distributors. For application assistance, current specifications, pricing or the nearest Authorized Distributor, visit sensing.honeywell.com or call:

| | |
|--------------|---------------------|
| Asia Pacific | +65 6355-2828 |
| Europe | +44 (0) 1698 481481 |
| USA/Canada | +1-800-537-6945 |

Honeywell Sensing and Internet of Things

9680 Old Bailes Road
Fort Mill, SC 29707
honeywell.com

WARNING

PERSONAL INJURY

DO NOT USE these products as safety or emergency stop devices or in any other application where failure of the product could result in personal injury.

Failure to comply with these instructions could result in death or serious injury.

WARNING

MISUSE OF DOCUMENTATION

- The information presented in this product sheet is for reference only. Do not use this document as a product installation guide.
- Complete installation, operation, and maintenance information is provided in the instructions supplied with each product.

Failure to comply with these instructions could result in death or serious injury.

WARRANTY/REMEDY

Honeywell warrants goods of its manufacture as being free of defective materials and faulty workmanship. Honeywell's standard product warranty applies unless agreed to otherwise by Honeywell in writing; please refer to your order acknowledgement or consult your local sales office for specific warranty details. If warranted goods are returned to Honeywell during the period of coverage, Honeywell will repair or replace, at its option, without charge those items it finds defective. **The foregoing is buyer's sole remedy and is in lieu of all other warranties, expressed or implied, including those of merchantability and fitness for a particular purpose. In no event shall Honeywell be liable for consequential, special, or indirect damages.**

While we provide application assistance personally, through our literature and the Honeywell website, it is up to the customer to determine the suitability of the product in the application.

Specifications may change without notice. The information we supply is believed to be accurate and reliable as of this printing. However, we assume no responsibility for its use.