

Voltage Regulators, Peak Power Zener Surge Rated, 600 Watt

BZG03C15 Series

The SMA series is supplied in ON Semiconductor's exclusive, cost-effective, highly reliable SURMETIC™ package and is ideally suited for use in communication systems, automotive, numerical controls, process controls, medical equipment, business machines, power supplies and many other industrial/consumer applications. This new line of 1.5 watt Zener diodes offers the following advantages:

Specification Features

- Standard Zener Breakdown Voltage – 15 V to 150 V
- Peak Power 600 Watts @ 100 μ s
- ESD Rating of Class 3 (> 16 KV) per Human Body Model
- Response Time is Typically < 1.0 ns
- Flat Handling Surface for Accurate Placement
- Package Design for Top Slide or Bottom Circuit Board Mounting
- Low Profile Package
- These Devices are Pb-Free, Halogen Free/BFR Free and are RoHS Compliant

Mechanical Characteristics

CASE: Void-free, transfer-molded plastic

FINISH: All external surfaces are corrosion resistant and leads are readily solderable

MAXIMUM CASE TEMPERATURE FOR SOLDERING PURPOSES: 260°C for 10 Seconds

POLARITY: Cathode indicated by molded polarity notch or polarity band

MOUNTING POSITION: Any



ON Semiconductor®

www.onsemi.com

PLASTIC SURFACE MOUNT ZENER VOLTAGE REGULATORS 600 WATTS PEAK POWER

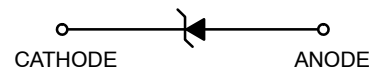

SMA
CASE 403D

MARKING DIAGRAM



- XXX = Specific Device Code (See Table on Page 2)
- A = Assembly Location
- Y = Year
- WW = Work Week
- = Pb-Free Package

ORDERING INFORMATION

Device	Package	Shipping†
BZG03C15G	SMA (Pb-Free)	5000/Tape & Reel
BZG03C150G	SMA (Pb-Free)	5000/Tape & Reel

†For information on tape and reel specifications, including part orientation and tape sizes, please refer to our Tape and Reel Packaging Specification Brochure, BRD8011/D.

BZG03C15 Series

MAXIMUM RATINGS

Rating	Symbol	Value	Unit
Peak Power Dissipation (Note 1) @ $T_L = 25^\circ\text{C}$, $t_p = 100 \mu\text{s}$	P_{ZSM}	600	W
DC Power Dissipation @ $T_L = 75^\circ\text{C}$ Measured Zero Lead Length (Note 2) Derate Above 75°C	P_D	1.5	W
Thermal Resistance, Junction-to-Lead	$R_{\theta JL}$	20 50	mW/ $^\circ\text{C}$ $^\circ\text{C}/\text{W}$
Forward Surge Current (Note 3) @ $T_A = 25^\circ\text{C}$	I_{FSM}	40	A
Operating and Storage Temperature Range	T_J, T_{stg}	-65 to +150	$^\circ\text{C}$

Stresses exceeding those listed in the Maximum Ratings table may damage the device. If any of these limits are exceeded, device functionality should not be assumed, damage may occur and reliability may be affected.

- 100 μs , non-repetitive square pulse
- 1 in. square copper pad, FR-4 board
- 1/2 sine wave (or equivalent square wave), PW = 8.3 ms, duty cycle = 4 pulses per minute maximum

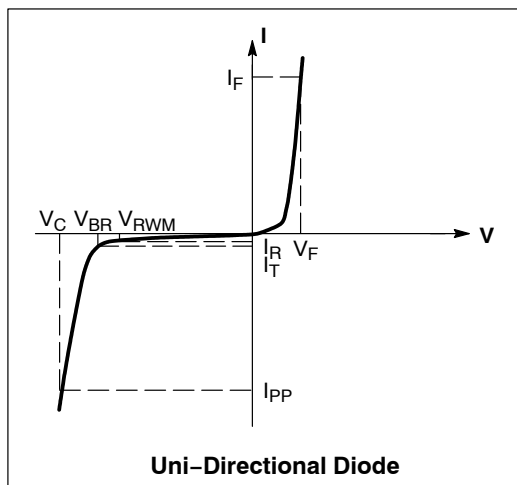

SYMBOLS DEFINITIONS

Symbol	Parameter
I_{PP}	Maximum Reverse Peak Pulse Current
V_C	Clamping Voltage @ I_{PP}
V_{RWM}	Working Peak Reverse Voltage
I_R	Maximum Reverse Leakage Current @ V_{RWM}
V_{BR}	Breakdown Voltage @ I_T
I_T	Test Current
I_F	Forward Current
V_F	Forward Voltage @ I_F

ELECTRICAL CHARACTERISTICS ($T_A = 25^\circ\text{C}$ unless otherwise noted, $V_F = 1.2 \text{ V Max.}$ @ $I_F = 0.5 \text{ A}$ for all types)

Device*	Device Marking	V_{RWM} (Note 4) Volts	$I_R @ V_{RWM}$ μA	Breakdown Voltage			$Z_{zt} @ I_T$		
				$V_{BR} (V)$ (Note 5)			@ I_T	Typ	Max
				Min	Nom	Max	mA	Ω	Ω
BZG03C15, G	G15	11	1	13.8	15.0	15.6	50	5.0	10.0
BZG03C150, G	G150	110	1	138	150	156	5	130	300

4. A transient suppressor is normally selected according to the working peak reverse voltage (V_{RWM}), which should be equal to or greater than the DC or continuous peak operating voltage level

5. V_{BR} measured at pulse test current I_T at an ambient temperature of 25°C

*The "G" suffix indicates Pb-Free package available.

BZG03C15 Series

RATING AND TYPICAL CHARACTERISTIC CURVES

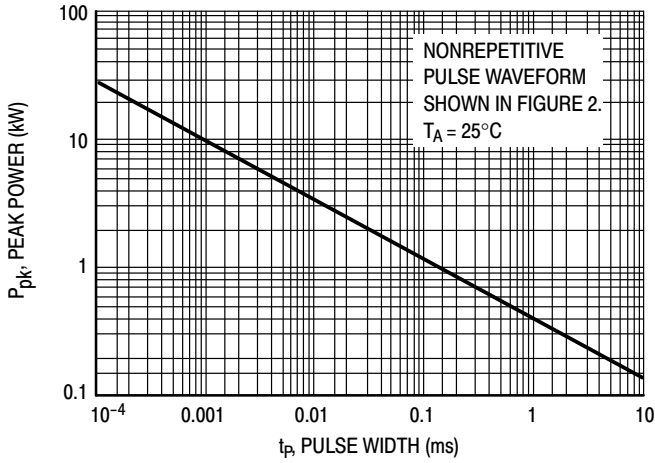

Figure 1. Pulse Rating Curve

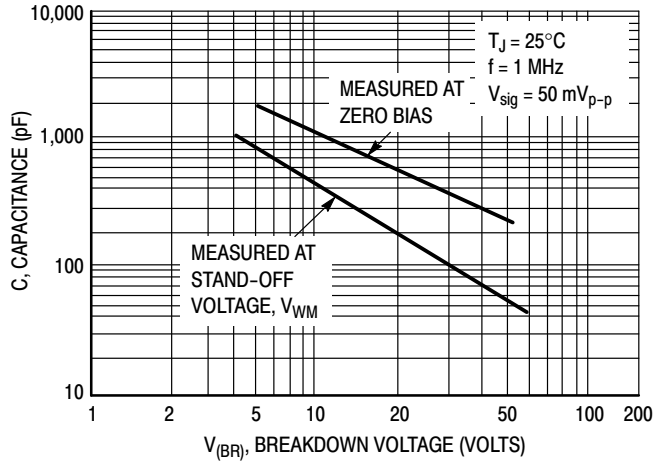

Figure 3. Typical Junction Capacitance

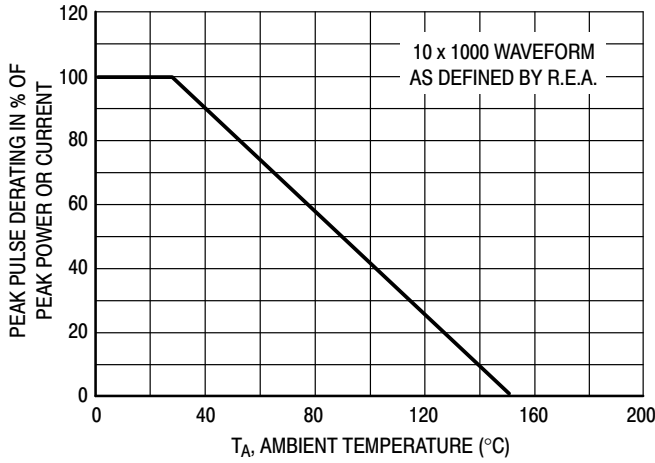

Figure 2. Pulse Derating Curve

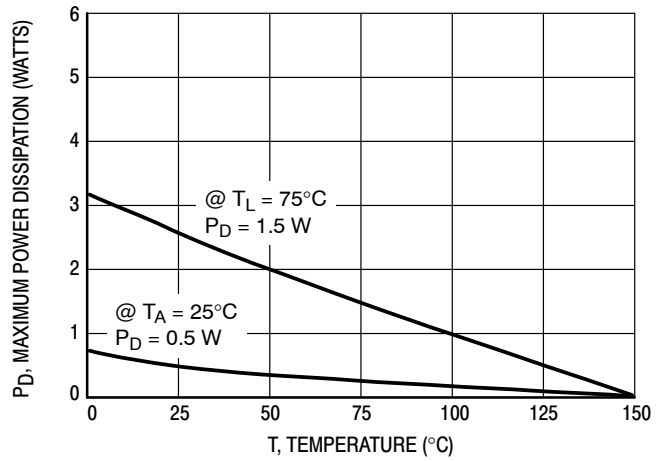
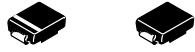

Figure 4. Steady State Power Derating

MECHANICAL CASE OUTLINE

PACKAGE DIMENSIONS

ON Semiconductor®



STYLE 1 STYLE 2

SCALE 1:1

SMA CASE 403D ISSUE H

DATE 23 SEP 2015

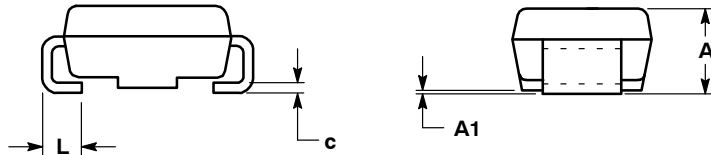
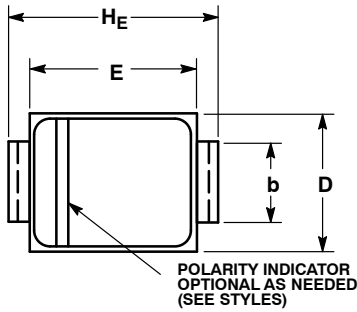

SOLDERING FOOTPRINT*

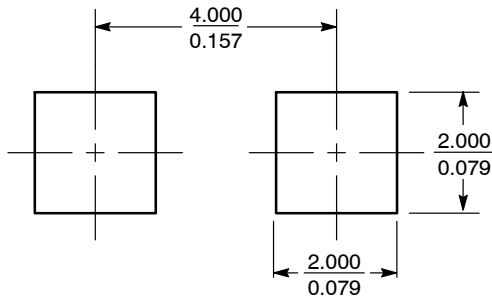

SCALE 8:1 (mm/inches)

*For additional information on our Pb-Free strategy and soldering details, please download the ON Semiconductor Soldering and Mounting Techniques Reference Manual, SOLDERRM/D.

NOTES:

1. DIMENSIONING AND TOLERANCING PER ANSI Y14.5M, 1982.
2. CONTROLLING DIMENSION: INCH.
3. DIMENSION b SHALL BE MEASURED WITHIN DIMENSION L.

DIM	MILLIMETERS			INCHES		
	MIN	NOM	MAX	MIN	NOM	MAX
A	1.97	2.10	2.20	0.078	0.083	0.087
A1	0.05	0.10	0.20	0.002	0.004	0.008
b	1.27	1.45	1.63	0.050	0.057	0.064
c	0.15	0.28	0.41	0.006	0.011	0.016
D	2.29	2.60	2.92	0.090	0.103	0.115
E	4.06	4.32	4.57	0.160	0.170	0.180
HE	4.83	5.21	5.59	0.190	0.205	0.220
L	0.76	1.14	1.52	0.030	0.045	0.060

GENERIC MARKING DIAGRAM*

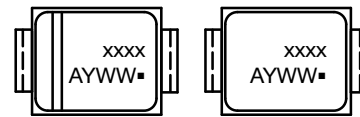

STYLE 1

STYLE 2

- xxxx = Specific Device Code
- A = Assembly Location
- Y = Year
- WW = Work Week
- = Pb-Free Package

*This information is generic. Please refer to device data sheet for actual part marking. Pb-Free indicator, "G" or microdot "■", may or may not be present.

STYLE 1:
PIN 1. CATHODE (POLARITY BAND)
2. ANODE

STYLE 2:
NO POLARITY

DOCUMENT NUMBER:	98AON04079D	Electronic versions are uncontrolled except when accessed directly from the Document Repository. Printed versions are uncontrolled except when stamped "CONTROLLED COPY" in red.
DESCRIPTION:	SMA	PAGE 1 OF 1

ON Semiconductor and are trademarks of Semiconductor Components Industries, LLC dba ON Semiconductor or its subsidiaries in the United States and/or other countries. ON Semiconductor reserves the right to make changes without further notice to any products herein. ON Semiconductor makes no warranty, representation or guarantee regarding the suitability of its products for any particular purpose, nor does ON Semiconductor assume any liability arising out of the application or use of any product or circuit, and specifically disclaims any and all liability, including without limitation special, consequential or incidental damages. ON Semiconductor does not convey any license under its patent rights nor the rights of others.

ON Semiconductor and  are trademarks of Semiconductor Components Industries, LLC dba ON Semiconductor or its subsidiaries in the United States and/or other countries. ON Semiconductor owns the rights to a number of patents, trademarks, copyrights, trade secrets, and other intellectual property. A listing of ON Semiconductor's product/patent coverage may be accessed at www.onsemi.com/site/pdf/Patent-Marking.pdf. ON Semiconductor reserves the right to make changes without further notice to any products herein. ON Semiconductor makes no warranty, representation or guarantee regarding the suitability of its products for any particular purpose, nor does ON Semiconductor assume any liability arising out of the application or use of any product or circuit, and specifically disclaims any and all liability, including without limitation special, consequential or incidental damages. Buyer is responsible for its products and applications using ON Semiconductor products, including compliance with all laws, regulations and safety requirements or standards, regardless of any support or applications information provided by ON Semiconductor. "Typical" parameters which may be provided in ON Semiconductor data sheets and/or specifications can and do vary in different applications and actual performance may vary over time. All operating parameters, including "Typicals" must be validated for each customer application by customer's technical experts. ON Semiconductor does not convey any license under its patent rights nor the rights of others. ON Semiconductor products are not designed, intended, or authorized for use as a critical component in life support systems or any FDA Class 3 medical devices or medical devices with a same or similar classification in a foreign jurisdiction or any devices intended for implantation in the human body. Should Buyer purchase or use ON Semiconductor products for any such unintended or unauthorized application, Buyer shall indemnify and hold ON Semiconductor and its officers, employees, subsidiaries, affiliates, and distributors harmless against all claims, costs, damages, and expenses, and reasonable attorney fees arising out of, directly or indirectly, any claim of personal injury or death associated with such unintended or unauthorized use, even if such claim alleges that ON Semiconductor was negligent regarding the design or manufacture of the part. ON Semiconductor is an Equal Opportunity/Affirmative Action Employer. This literature is subject to all applicable copyright laws and is not for resale in any manner.

PUBLICATION ORDERING INFORMATION

LITERATURE FULFILLMENT:

Email Requests to: orderlit@onsemi.com

ON Semiconductor Website: www.onsemi.com

TECHNICAL SUPPORT

North American Technical Support:
Voice Mail: 1 800-282-9855 Toll Free USA/Canada
Phone: 011 421 33 790 2910

Europe, Middle East and Africa Technical Support:

Phone: 00421 33 790 2910

For additional information, please contact your local Sales Representative