



**Laserlyte Green 515nm
Alignment System**



The LaserLyte alignment system is a unique, user adjustable, plug and play system suitable for a wide range of applications. These include alignment, positioning of materials for garments, cloth, paper, wood and metal or where a guide is needed for such applications such as band saws and circular saws.

The latest G version utilises a semiconductor green laser diode to provide projections in highly visible green light. This allows the projections to be viewed in high ambient light levels or at longer distances whilst keeping laser power levels within a safe laser classification. The laser wavelength of 515nm is 3 times brighter to the human eye than the equivalent power in 635nm.

The G Range has two power ranges, the G10 (515nm, 10mW) and G50 (515nm, 50mW). The G10 power range offers six projections ranging from dots to crossed lines. A unique focus mechanism also allows the user to adjust the focus without removing any optics or exposing the user to the raw laser beam. This ensures all G10 models conform to Class 2 and 2M. The G50 models offer higher power levels for the most demanding applications and conforms to laser class 3R.

A range of mounts, mounting brackets, electrical leads and power supplies allow the system to provide a complete solution ready to use with no previous laser experience required.



Selection Guide

This catalogue covers the Green LaserLyte Range and is broken down into various sections. Please use the guide below to go straight to the relevant section.

Section	Product	Description
S1	Features	An in-depth look at the features.
S2	Model Matrix	List of powers and projections options available.
S3	Specifications	Full specification for the Green LaserLyte.
S4	Optical Data	Line length, thickness and spot size information.
S5	Fan Angle & Working Distance	Using the LaserLyte Alignment System at different angles.
S6	Ordering	What you get when you purchase a Green LaserLyte.
S7	Applications	Just a small selection of the applications that the LaserLyte Alignment System is ideal for.
S8	Accessories	A list of accessories available and ordering numbers.
S9	Laser Safety	Laser safety advice and classifications.
S10	Mechanical	Mechanical drawings for the Green LaserLyte.

S1. Features

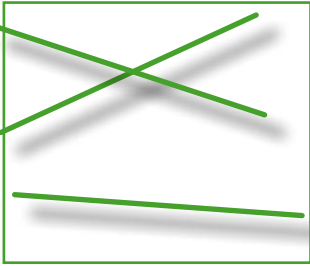

Multiple Projections & Brightness

The Green LaserLyte Alignment System has two power options in the 515nm wavelength. Outputs are the G10 (515nm, 10mW) and G50 (515nm, 50mW). Each one has a wide range of different projections from dots to variable intersecting crosses enabling them to meet a wide range of alignment applications.

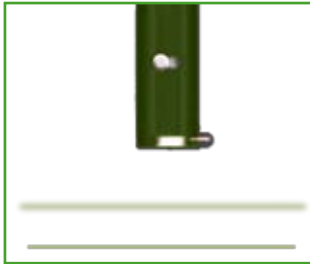

Adjustable Focus

The G range has a unique user adjustable focus control which allows the user to focus (vary the thickness of the projection) the laser at any required distance without the inconvenience of remove any projection lens. A focus key is supplied to enable this.

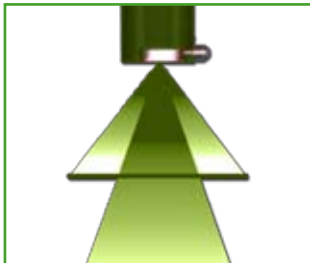

Adjustable Projections

A wide range of the LaserLyte modules feature an adjustable projection control, this allows the user to vary projection of the laser such as the intensity of the dot, the length of the line and adjust the intersection angle of the cross to produce a 90° cross at any mounted position. (See *model matrix for further details*).



Plug & Play

The LaserLyte Alignment System has been designed so that the user can operate the system efficiently and effectively via simple 2.5mm DC connector jack plugs.



MK1 Mounting Kit

The MK1 mounting kit is compatible with the G range. The laser clamp rotates horizontally through 360° and vertically through 180° and the mounting post allows vertical movement. The mounting clamp is compatible with Global Laser's mounting brackets and is supplied with two different lengths of machine screws to increase the range of mounting surfaces which can be utilized.



Heavy Duty Mounting Clamp

The heavy duty clamp has parallel and vertical adjustment which allows the user to aim the laser in any required direction or angle. The base plate of the heavy duty clamp has a series of threaded holes to allow the heavy duty clamp to be securely fastened to stable surface.



Magnetic Base

A magnetic base is also available which simply screws in to the base of the heavy duty clamp and allow it to be fitted to a ferrous surface.



Rail & Carriage Systems

Options range from the simple slide rail system where carriages can be moved by hand and locked into position, to computer controlled, motor driven systems. All systems incorporate long life/low friction polymer bearings which are self lubricating, removing the need for messy dirt, attracting oils and greases. The rails are also hard anodized to further increase ruggedness.



Power Supply

The PS-1 & PS-4 range run on 110-240Vac input via an IEC mains lead (supplied) and have the benefit of a power on LED indicator. An optional key switch allows the power supply output to be switched on/off at the power supply. The PS-1 has one output to power one laser and the PS-4 has four outputs to power four lasers.



Battery Box Power Supply















The power source is a compact ABS box and operates from eight industrial AAA batteries and can provide power for up to 8 hours of laser operation (Laser model dependent). A 2.5mm DC jack connector is fitted which is compatible with a wide range of Global Laser products and an on/off switch allows the user to control laser output and battery lifetime.



Safety Glasses

Laser safety Glasses to protect laser users against potentially harmful laser output. The range of glasses available cover all models in the LaserLyte Alignment range. Available in a wide variety of styles and filter types including neutral density and block outs. The safety glasses are covered by a lifetime warranty.

S2. Model Matrix

						
	Dot (D)	Dot With Variable Intensity (DVI)	Variable Length Line (VLL) <i>Fan Angle 30° to 90°</i>	Long Line With Dot (LL+D) <i>Fan Angle 90°</i>	Intersecting Crossed Lines (RXL) <i>Fan Angle 55°</i>	Small Cross With Variable Intensity (Xvi) <i>Fan Angle 9°</i>
G10						
G50						

Key To Projections	
D = Dot; which you can focus to a precise spot at any distance	LL+D = Long 90° line with central dot enabling both vertical and horizontal alignment
Dvi = Dot; which you can focus to a precise spot at any distance, and vary the intensity	RXL = Crossed Lines which can be rotated to intersect at any angle, from any angle of mounting
VLL = Variable Length Line; you can double the length of the line by spreading light from 30° to 90° fan angle	Xvi = Small fixed cross which also has variable intensity

S3. LaserLyte Specifications

	G10	G50
Mechanical Information		
Width by Height (mm)	14 x 69	
Housing	Green Anodized Aluminium	
Isolated Body	Yes	
Optical Information		
Diode Power (mW)	10	50
Wavelength (nm)	515	
Laser Class (IEC60825-1 2007)	Dependant on optic fitted *	
Intensity Distribution (Output Beam)	Gaussian	
Focus Range (mm)	100 to infinity	
Delivery Set Focus (mm)	1000 (User Adjustable)	
Environmental Information		
Operating Case Temperature (°C)	-10 to +55	
Storage Temperature (°C)	-10 to +85	
Operating Humidity (%RH)	90	
MTTF @ 25°C (hrs)	≥40,000	≥20,000
Electrical Specifications		
Connector Type	DC Power Jack 2.5mm, Centre pin: 0V, Outer +Ve	
Operating Voltage (Vdc)	+10	
Operating Current (mA)	≤ 100	≤ 150
Reverse Polarity Protection	Yes	
Approximate operating time when powered via the Battery Box (Hours)	11.5	7.5
NOTES * See model and laser class table All specifications are typical @ 25°C		

S4. Optical Data

LaserLyte Dot (D): Spot Size over Working Distance

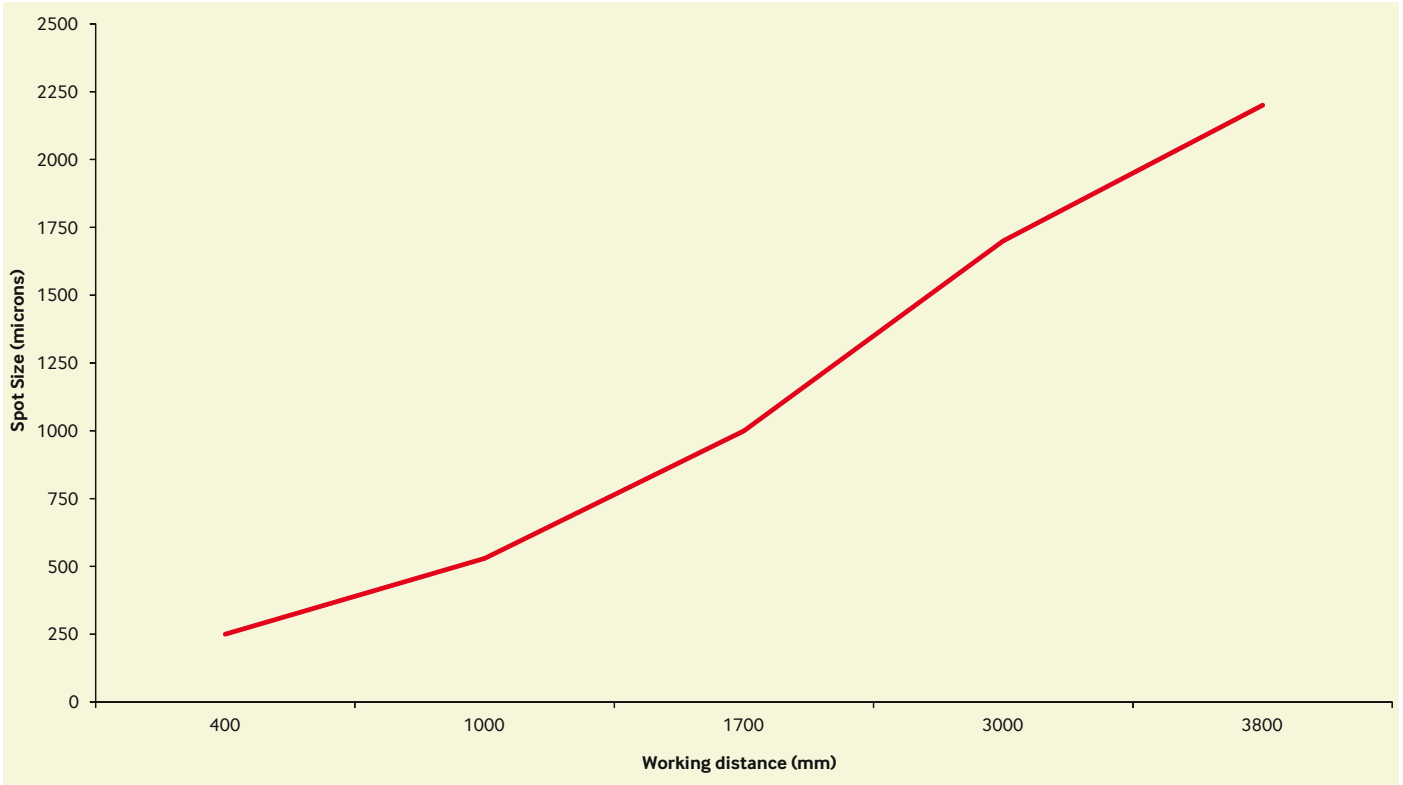

LaserLyte Variable Length Line (VLL): Line Thickness over Working Distance

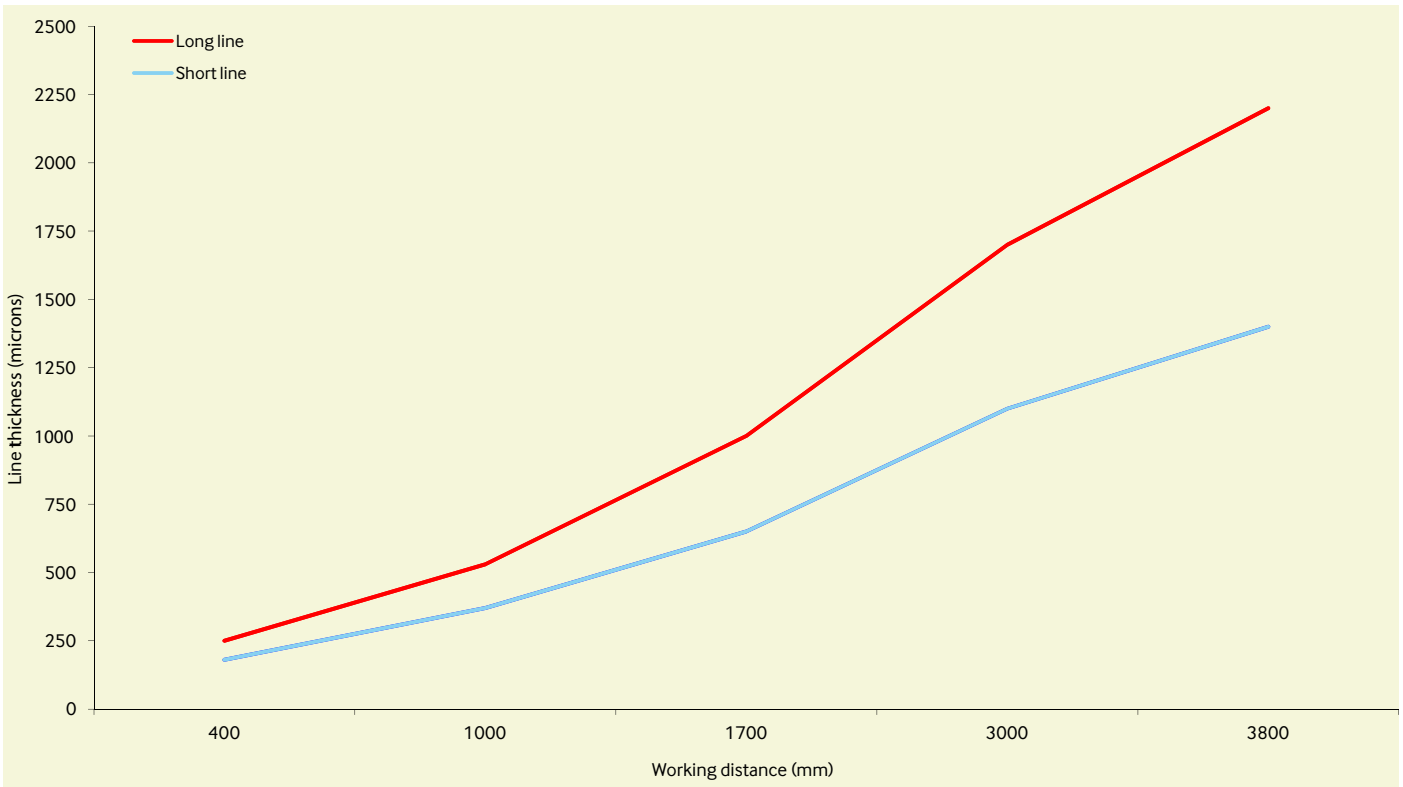

LaserLyte Intersecting Crossed Lines (RXL): Line Thickness over Working Distance in the X and Y Axis

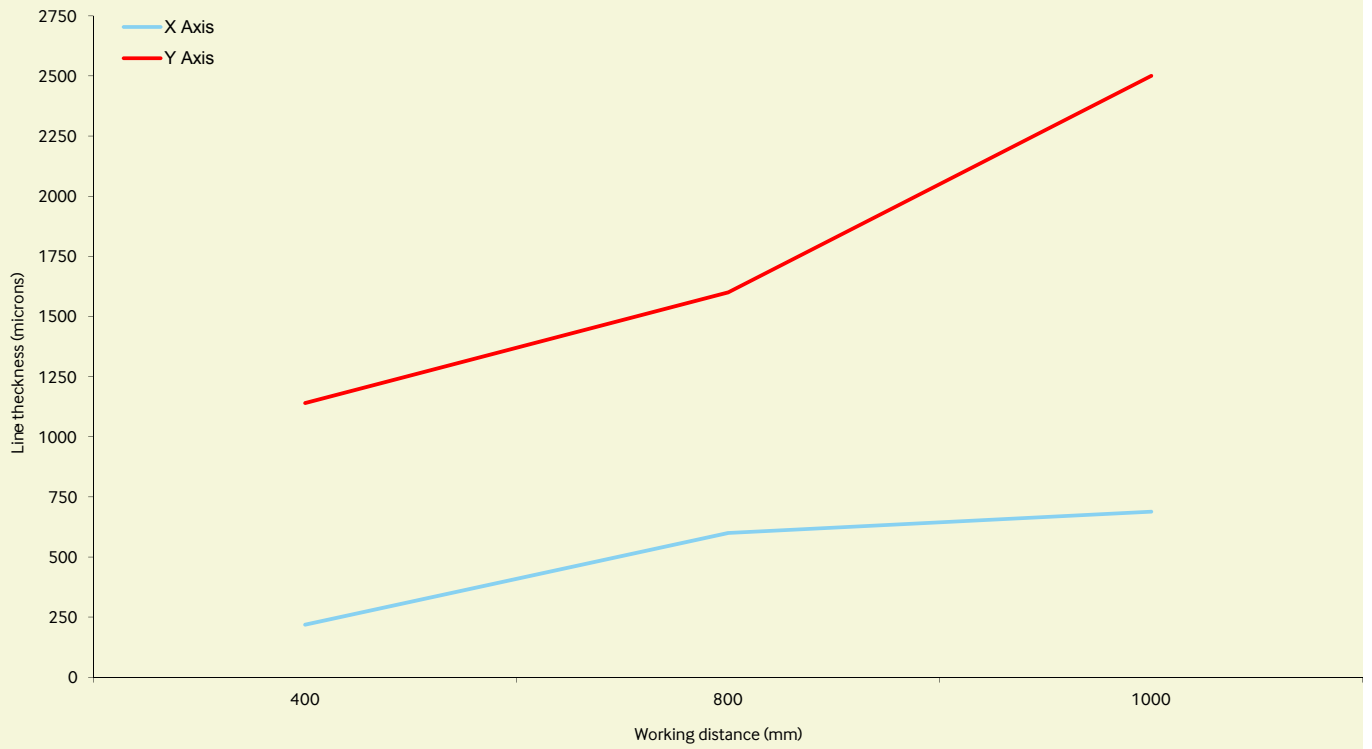

S5. Fan Angle & Working Distance

The size of the fan angle (or spread of the beam) will determine how long the line is. When viewed from the same distance and at 90 degrees to the surface a line with a fan angle of 90 degrees will be longer than a line with a fan angle of 30 degrees.

Fan Angle (Degrees)	Distance to Object (mm)	Line Length (mm)
30	100	54
90	100	168

As a guide to relationship between working distance, line length and fan angle please see table below.

		Fan Angle (Degrees)				
		7.7°	30°	55°	90°	
Distance From Object (mm)	250	34	134	260	500	Line Length (mm)
	500	67	268	521	1000	
	750	101	402	781	1500	
	1000	135	536	1041	2000	
	1250	168	670	1301	2500	
	1500	202	804	1562	3000	
	1750	236	938	1822	3500	
	2000	269	1072	2082	4000	
	2250	303	1206	2343	4500	
	2500	336	1340	2603	5000	
	2750	370	1474	2863	5500	
	3000	404	1608	3123	6000	
	3250	437	1742	3384	6500	
	3500	471	1876	3644	7000	
	3750	505	2010	3904	7500	
	4000	538	2144	4165	8000	
	4250	572	2278	4425	8500	
	4500	606	2412	4685	9000	
4750	639	2546	4945	9500		
5000	673	2679	5206	10000		
5250	707	2813	5466	10500		
5500	740	2947	5726	11000		

S6. Ordering

When ordering from Global Laser directly the following accessories are included with the as standard with the LaserLyte Alignment System:

G Range

x1 Laser, x1 MK1 Mounting Clamp, x1 1.5m Electrical Lead, x1 Focus Key

S7. LaserLyte Accessories

The following parts can be purchased individually as accessories to accompany the LaserLyte Range.

	Part Number	Description
Mounting Accessories		
Heavy Duty Mounting Clamp	1240-02-000	Heavy Duty Mounting Clamp 14mm - LaserLyte
MK1 Mounting Clamp	5000-50-000	MK1 LaserLyte Mounting Kit
Magnetic Base	1235-00-000	Magnetic Base with M6 Stud
Brackets	5000-55-000	B2 - 5cm/2" Bracket
	5000-54-000	B4 - 10cm/4" Bracket
	5000-59-000	B6 - 15cm/6" Bracket
	5000-52-000	B12 - 30cm/12" Bracket
	5000-51-000	Set of 4 Brackets
Electrical Options		
1 Outlet Power Supply	5026-29-000	PS-1 10V with UK Mains Lead
	5026-30-000	PS-1 10V with US Mains Lead
	5026-28-000	PS-1 10V with Euro Mains Lead
4 Outlet Power Supply	5026-34-000	PS-4 10V with UK Mains Lead
	5026-35-000	PS-4 10V with US Mains Lead
	5026-36-000	PS-4 10V with EURO Mains Lead
Battery Box Power Supply for 1 Laser	5040-02-000	LaserLyte Green 515nm Battery Box (Including Batteries)
Power Leads	5200-28-000	1.5m Power Lead
	5200-30-000	3m Power Lead
	5200-59-000	5m Power Lead
	5200-34-000	10m Power Lead
	5200-67-000	20m Power Lead
Laser Safety Glasses		
Green Laser Safety Glasses	1990-05-000	480-532nm Laser Safety Glasses - Wraparound Style
	1991-03-000	480-532nm Laser Safety Glasses - Overglasses Style

S8. LaserLyte Applications

The LaserLyte Alignment System is suitable for many different applications some of which are below. If you would like to know further information about any other applications please refer to the LaserLyte MK3 Applications Handbook or contact Global Laser.

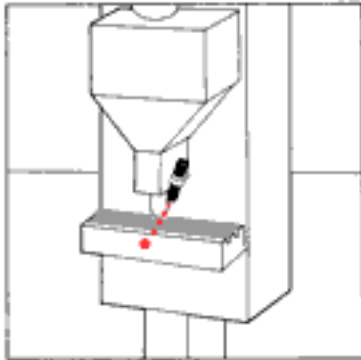

Machine Alignment

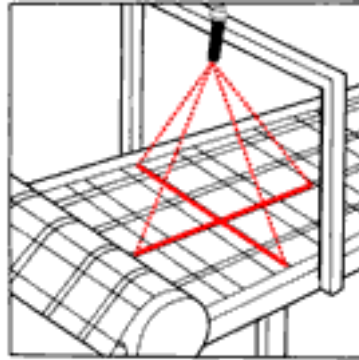

Pattern Alignment

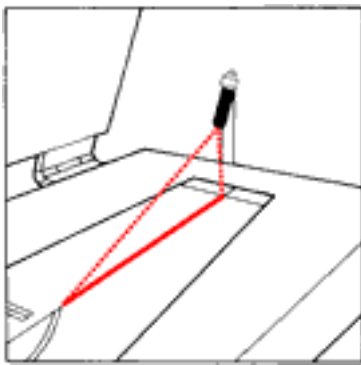

Positioning

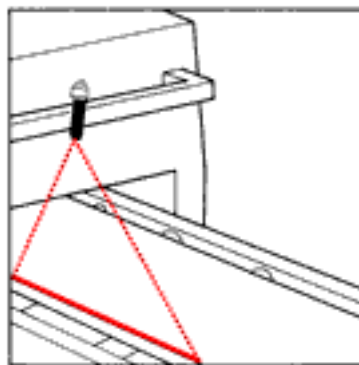

Edge Alignment

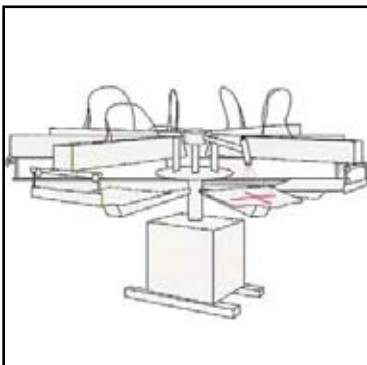

Screen Printing

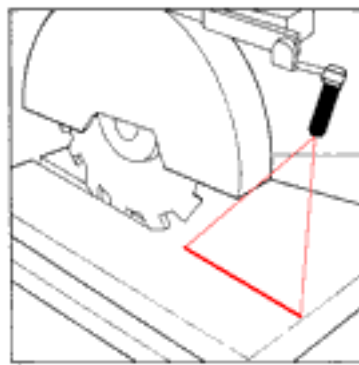

Saw & Cutting Guidance

S9. Laser Safety

Model	Classification of the Laser Power Out Conform to
G10D	Class 2
G10VLL, G10RXL, G10Xvi, G10Dvi	Class 2M
G50VLL & G50RXL	Class 3R

Our Lasers are compliant to IEC 60825-1 2007 standards. The lasers fall within one of the following classifications depending on power, wavelength and fan angle. The labels supplied with the units are shown below.

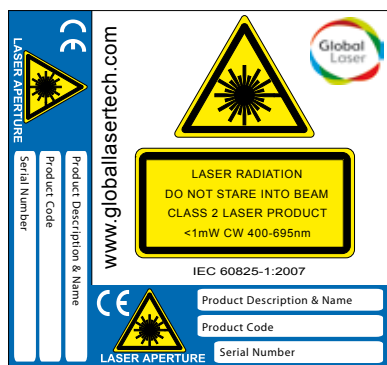

Class 2 Laser Label

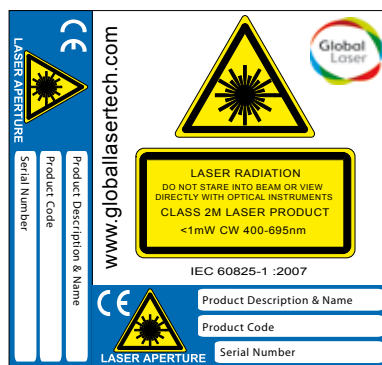

Class 2M Laser Label

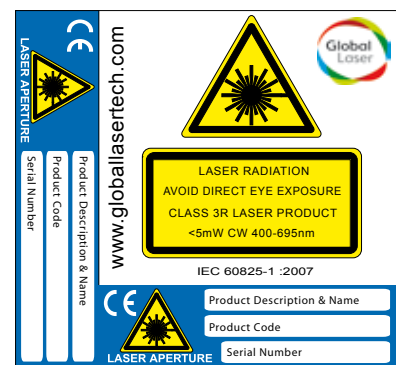

Class 3R Laser Label

S10. Mechanical Dimensions

G - LaserLyte Laser Diode Module

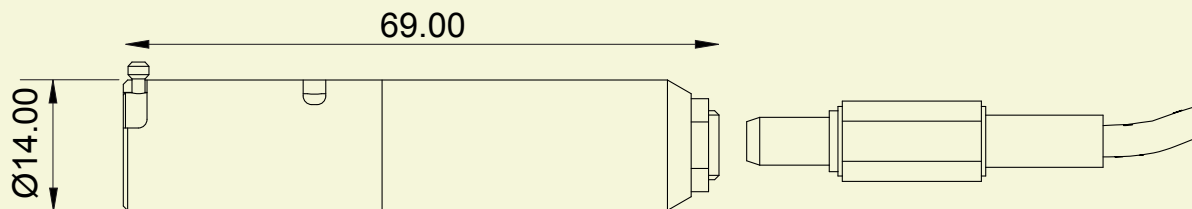

Heavy Duty Mounting Clamp

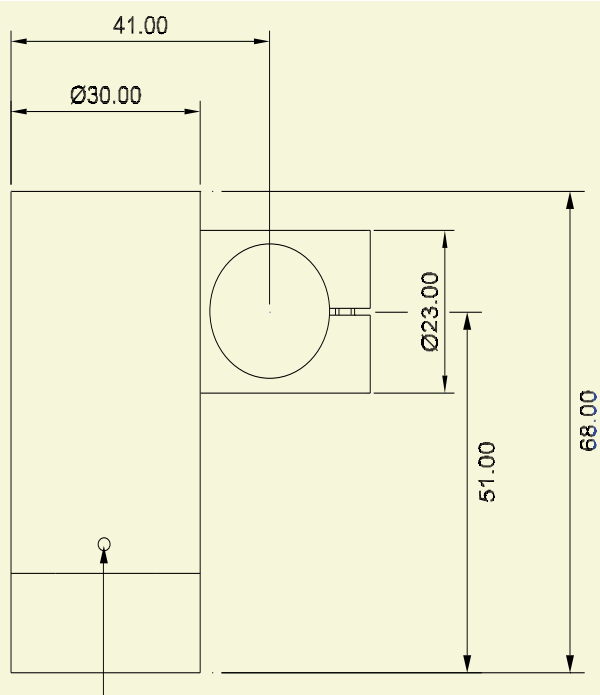

Grub Screw (M3)

MK1 Clamp

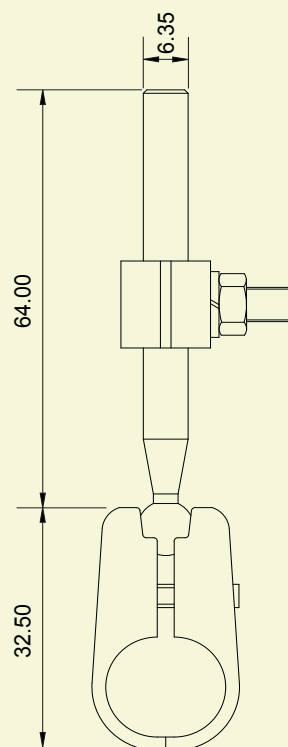

Quality & Warranty

The LaserLyte range is supplied with a 12 month parts and labour warranty. Our manufacturing operations are certified to ISO9001.



T: +44 (0)1495 212213
F: +44 (0)1495 214004
E: sales@globalasertech.com
www.globalasertech.com

Global Laser Ltd
Unit 9-10
Roseheyworth Business Park
Abertillery, Gwent NP13 1SP UK