



# STTH30R06CW

## TURBO 2 ULTRAFAST HIGH VOLTAGE RECTIFIER

### MAIN PRODUCT CHARACTERISTICS

$I_{F(AV)}$	2 x 15 A
$V_{RRM}$	600 V
$I_{RM}$ (typ.)	8 A
$T_j$ (max)	175 °C
$V_F$ (max)	1.8 V
$t_{rr}$ (max)	50 ns

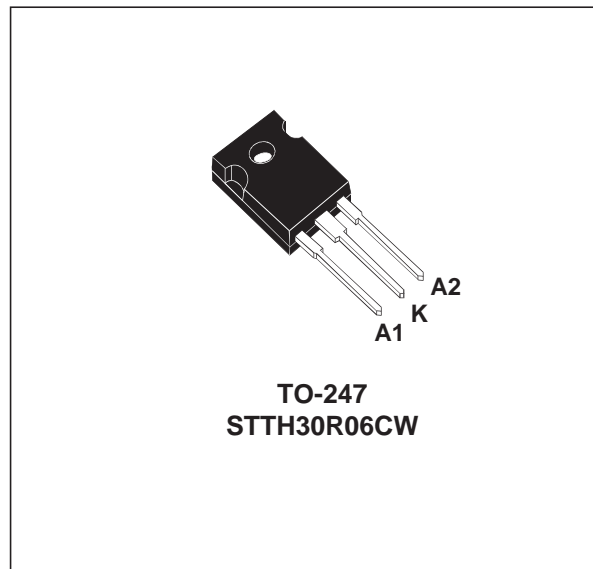
### FEATURES AND BENEFITS

- Ultrafast switching
- Low reverse recovery current
- Reduces switching losses
- Low thermal resistance

### DESCRIPTION

The STTH30R06CW, which is using ST Turbo 2 600V technology, is specially suited as boost diode in continuous mode power factor corrections and hard switching conditions.

The device is also intended for use as a free wheeling diode in power supplies and other power switching applications.



### ABSOLUTE RATINGS (limiting values)

Symbol	Parameter		Value	Unit
$V_{RRM}$	Repetitive peak reverse voltage		600	V
$I_{F(RMS)}$	RMS forward current		30	A
$I_{F(AV)}$	Average forward current	Per diode Per device	15 30	A
$I_{FSM}$	Surge non repetitive forward current	$t_p = 10$ ms Sinusoidal	120	A
$T_{stg}$	Storage temperature range		- 65 + 175	°C
$T_j$	Maximum operating junction temperature		175	°C

## STTH30R06CW

### THERMAL RESISTANCES

Symbol	Parameter		Value	Unit
R <sub>th(j-c)</sub>	Junction to case	Per diode	1.5	°C/W
		Total	1.0	
R <sub>th(c)</sub>		Coupling	0.5	

### STATIC ELECTRICAL CHARACTERISTICS (per diode)

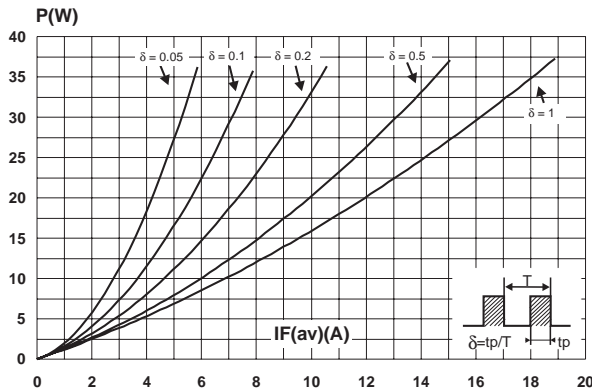
Symbol	Parameter	Tests conditions		Min.	Typ.	Max.	Unit
I <sub>R</sub>	Reverse leakage current	V <sub>R</sub> = 600V	T <sub>j</sub> = 25°C			60	μA
			T <sub>j</sub> = 125°C		70	800	
V <sub>F</sub>	Forward voltage drop	I <sub>F</sub> = 15 A	T <sub>j</sub> = 25°C			2.9	V
			T <sub>j</sub> = 125°C		1.4	1.8	

To evaluate the maximum conduction losses use the following equation :  
 $P = 1.16 \times I_{F(AV)} + 0.043 I_{F(RMS)}^2$

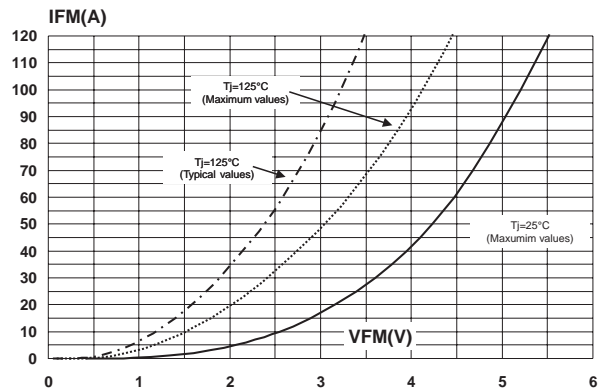
### DYNAMIC ELECTRICAL CHARACTERISTICS

Symbol	Tests conditions		Min.	Typ.	Max.	Unit	
trr	I <sub>F</sub> = 0.5 A I <sub>rr</sub> = 0.25 A I <sub>R</sub> = 1A		T <sub>j</sub> = 25°C			30	ns
	I <sub>F</sub> = 1 A dI <sub>F</sub> /dt = - 50 A/μs V <sub>R</sub> = 30V					50	
I <sub>RM</sub>	V <sub>R</sub> = 400 V I <sub>F</sub> = 15A		T <sub>j</sub> = 125°C		7.5	9.0	A
S factor	dI <sub>F</sub> /dt = - 200A/μs				0.15		
Q <sub>rr</sub>					220		
t <sub>fr</sub>	I <sub>F</sub> = 15 A dI <sub>F</sub> /dt = 120 A/μs		T <sub>j</sub> = 25°C			200	ns
V <sub>FP</sub>	V <sub>FR</sub> = 1.1 x V <sub>Fmax</sub>					6	

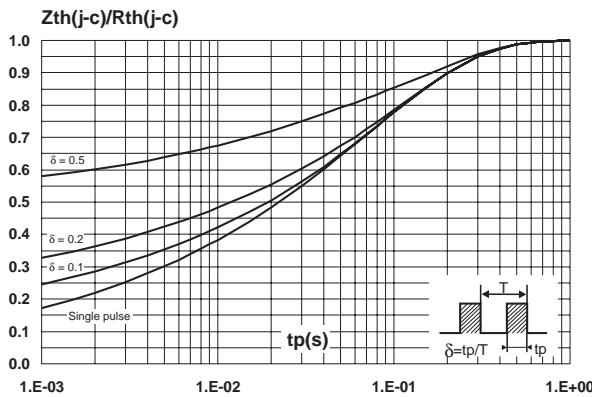
**Fig. 1:** Conduction losses versus average current (per leg).



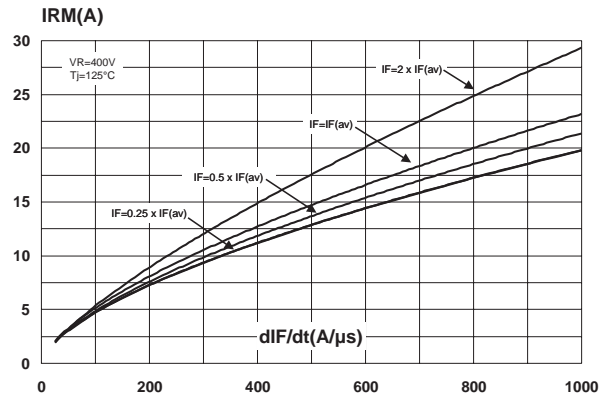
**Fig. 2:** Forward voltage drop versus forward current (per leg).



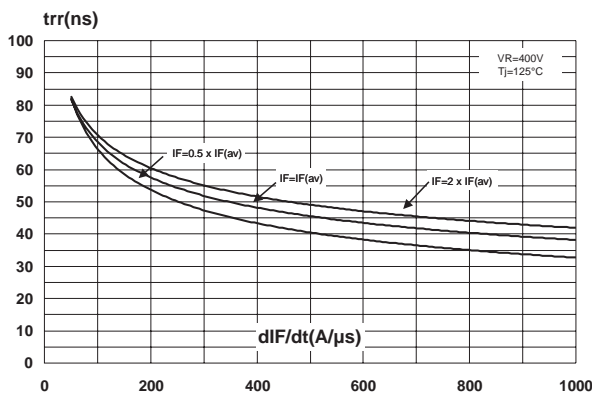
**Fig. 3:** Relative variation of thermal impedance junction to case versus pulse duration.



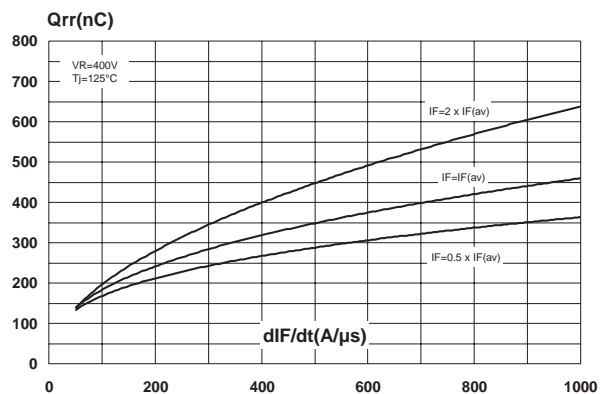
**Fig. 4:** Peak reverse recovery current versus  $di_F/dt$  (90% confidence, per leg).



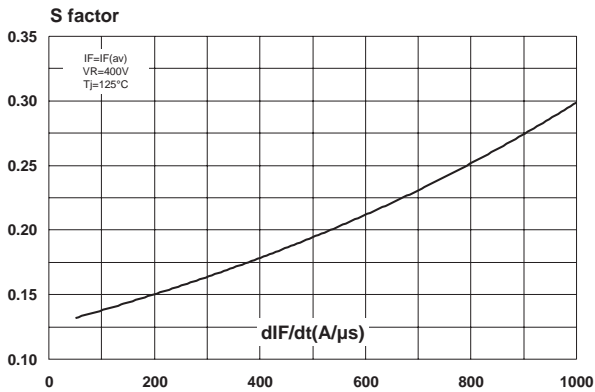
**Fig. 5:** Reverse recovery time versus  $di_F/dt$  (90% confidence, per leg).



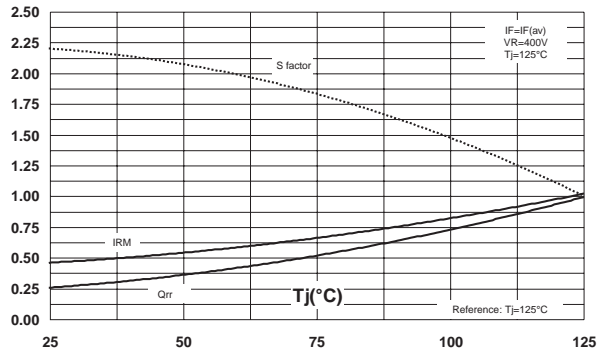
**Fig. 6:** Reverse recovery charges versus  $di_F/dt$  (90% confidence, per leg).



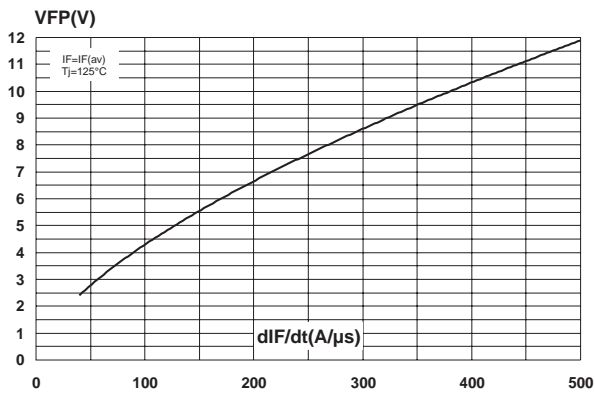
**Fig. 7:** Softness factor versus  $di_F/dt$  (typical values, per leg).



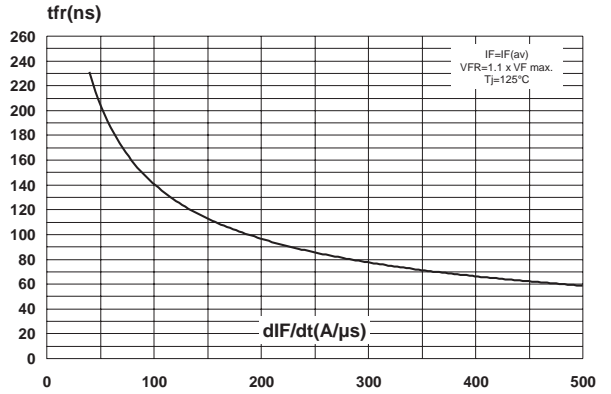
**Fig. 8:** Relative variation of dynamic parameters versus junction temperature.



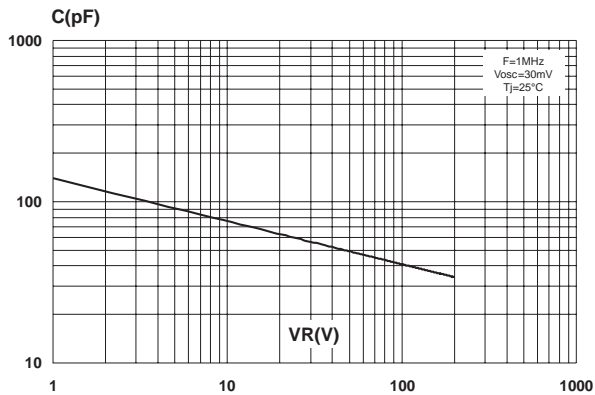
**Fig. 9:** Transient peak forward voltage versus  $di_F/dt$  (90% confidence, per leg).

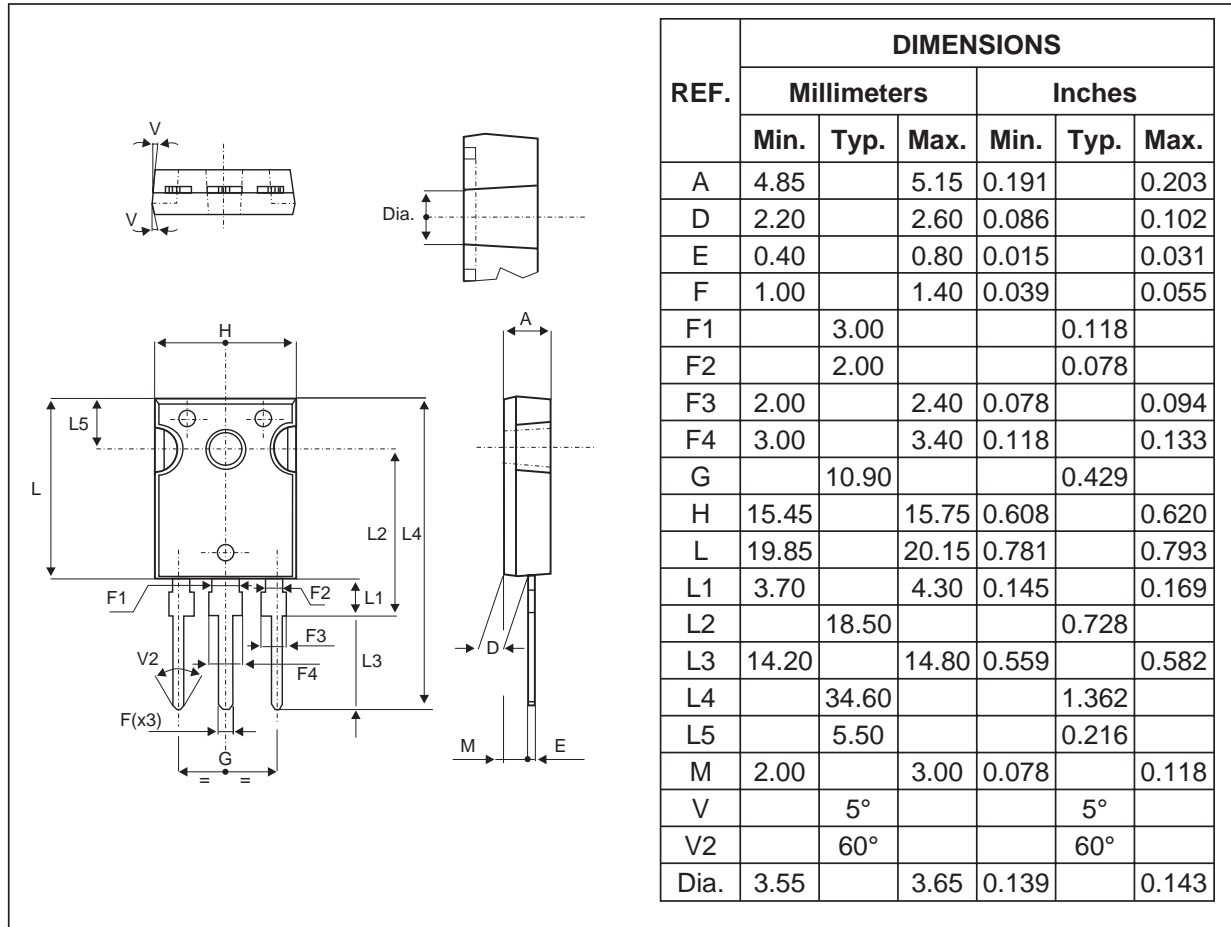


**Fig. 10:** Forward recovery time versus  $di_F/dt$  (90% confidence, per leg).



**Fig. 11:** Junction capacitance versus reverse voltage applied (typical values, per leg).



**PACKAGE MECHANICAL DATA**  
 TO-247


Ordering code	Marking	Package	Weight	Base qty	Delivery mode
STTH30R06CW	STTH30R06CW	TO-247	4.36 g	30	Tube

- Epoxy meets UL 94,V0

Information furnished is believed to be accurate and reliable. However, STMicroelectronics assumes no responsibility for the consequences of use of such information nor for any infringement of patents or other rights of third parties which may result from its use. No license is granted by implication or otherwise under any patent or patent rights of STMicroelectronics. Specifications mentioned in this publication are subject to change without notice. This publication supersedes and replaces all information previously supplied. STMicroelectronics products are not authorized for use as critical components in life support devices or systems without express written approval of STMicroelectronics.

The ST logo is a registered trademark of STMicroelectronics

© 2001 STMicroelectronics - Printed in Italy - All rights reserved.

STMicroelectronics GROUP OF COMPANIES

Australia - Brazil - China - Finland - France - Germany - Hong Kong - India - Italy - Japan - Malaysia  
 Malta - Morocco - Singapore - Spain - Sweden - Switzerland - United Kingdom - U.S.A.

<http://www.st.com>

