



Power Splitter

11667L/A/B/C/D: DC to 2/18/26.5/67 GHz

Key Features

- Broad operating frequency up to 67 GHz
- Excellent output VSWR at the auxiliary arm when used for source leveling or ratio measurement applications
- Unmatched tracking between outputs ensures minimum measurement uncertainty

Description

The Keysight Technologies, Inc. 11667x is a 50 ohm two-resistor type power splitter that provides exceptional amplitude and phase tracking for highly accurate power splitting. Offering excellent output power symmetry between the two output ports, the 11667x is recommended for applications that require external source leveling, ratio measurements and for other legacy network/ gain-phase analyzers that do not have built-in power splitters or directional bridges.

Applications

Network measurement

Milliohm impedance measurements with shunt-thru method (DC-DC converters, large bypass capacitors)

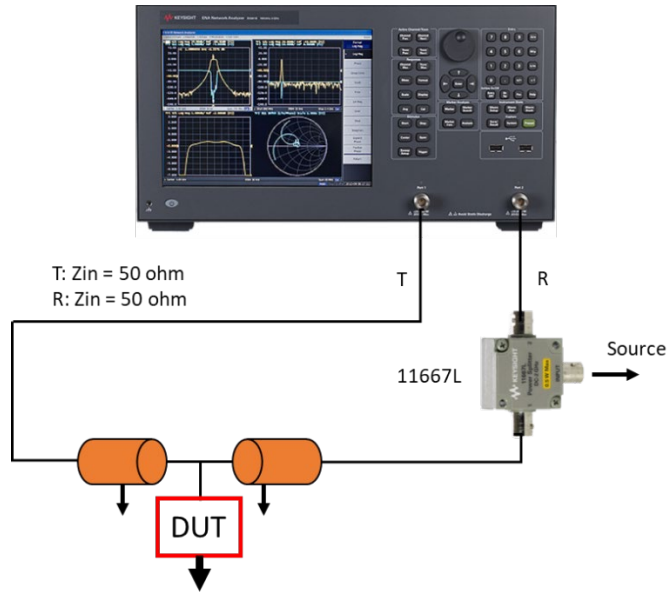

Figure 1. Shunt-thru impedance measurement

Transmission coefficient measurements for 2-port devices

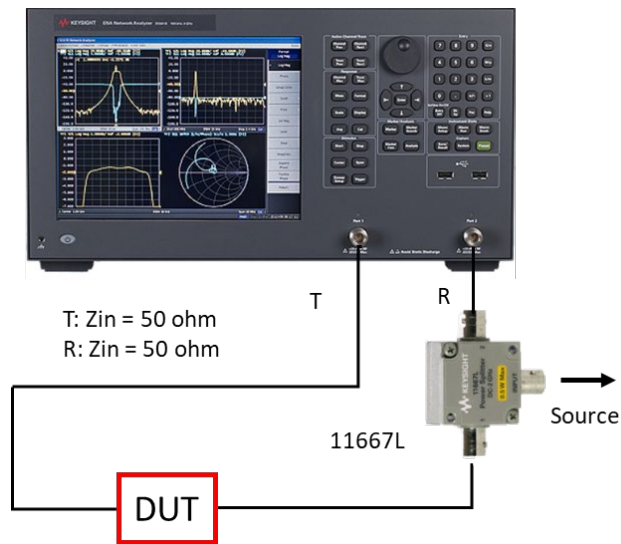

Figure 2. 50-ohm device measurement

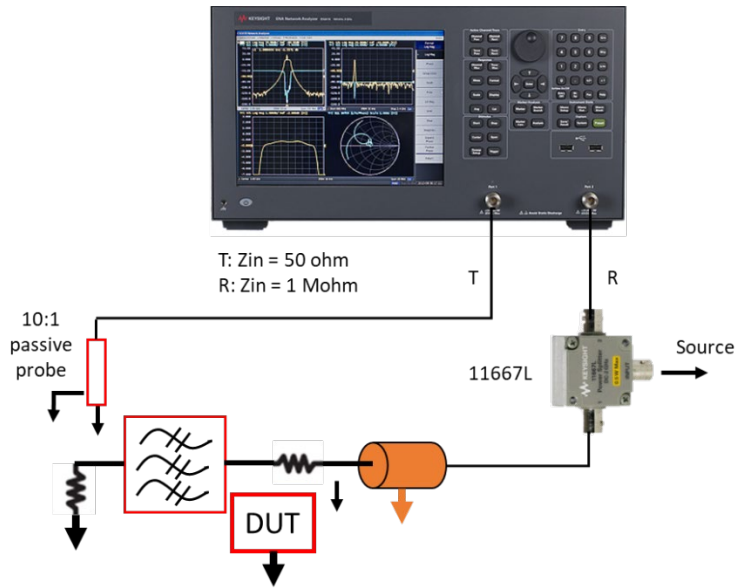

Figure 3. Non- 50-ohm LF filter measurement

Ratting and Leveling

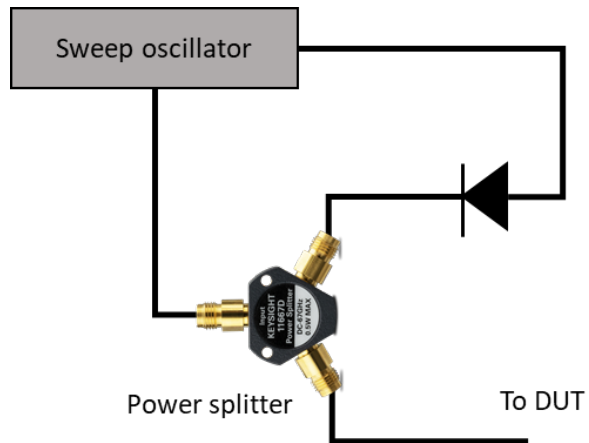

Figure 4. Power splitter test setup for leveling with a crystal detector

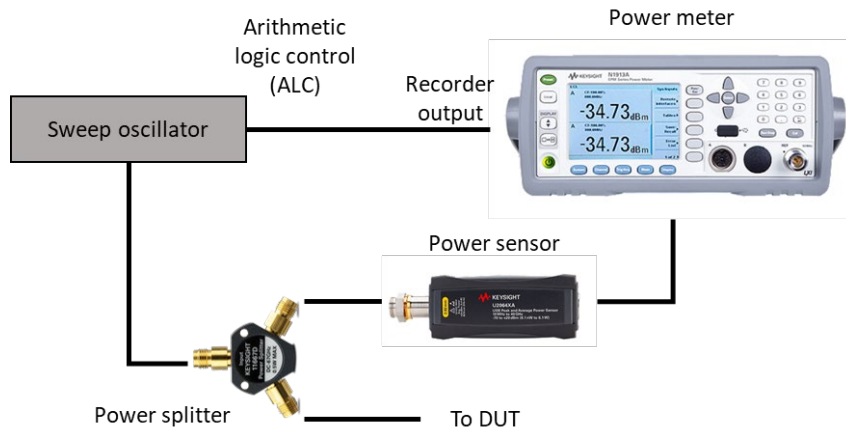

Figure 5. Power splitter test setup for leveling with a power meter

Specifications

Specifications describe the product's warranted performance. Supplemental and typical characteristics are intended to provide typical but non-warranted performance parameters. These are denoted as "typical", "nominal" or "approximate"

| Specifications | 11667L | 11667A | 11667B | 11667C | 11667D |
|-----------------------------------------|----------------------------------------------------------------|-------------------------------------------------------------------------------------------------------------------------------------------------------------------------------------------------------------------------------|---------------------------------------------------------------------------------------------------------------------|----------------------------------------------------------------------------------------------------------------------------------------------------------------------------------------------------------------------------|--------------------------------------------------------------------------------------------------------------------------------------------------------------------------------------------------------------------------------------------------------------------------------------------------------------------------|
| Frequency range | DC to 2 GHz | DC to 18 GHz | DC to 26.5 GHz | DC to 50 GHz | DC to 67 GHz |
| Connector | BNC (f) all ports | Type-N (f) all ports ¹ | 3.5 mm (f) all ports | 2.4 mm (f) all ports | 1.85 mm (f) all ports |
| Insertion loss (dB) | (6 dB nominal): DC to 100 MHz: 0.2 100 MHz to 2 GHz: 0.6 | (6 dB nominal): DC to 4 GHz: 0.2, + 0.6 to any output, typical 4 to 8 GHz: 0.2 + 1.0 to any output, typical 8 to 18 GHz: 0.2 + 1.8 to any output, typical | DC to 26.5 GHz: 7 dB typical | DC to 18 GHz: 6 18 to 26.5 GHz: 7 26.5 to 40 GHz: 8 40 to 50 GHz: 8.5 | DC to 18 GHz: 7.0 18 to 26.5 GHz: 7.5 26.5 to 40 GHz: 8.0 40 to 50 GHz: 8.5 50 to 67 GHz: 10.5 |
| Return loss, dB (VSWR) | Input: 18 (1.3) typical Output: 11 (1.78) typical | Input: DC to 4 GHz: 23 (1.15) 4 to 8 GHz: 19 (1.25) 8 to 18 GHz: 15 (1.45) Output: DC to 4 GHz: 26 (1.10) 4 to 8 GHz: 21 (1.20) 8 to 18 GHz: 17 (1.33) (8 to 18 GHz: 17 (1.38) for option 002 | Input: DC to 18 GHz: 20 (1.22) 18 to 26.5 GHz: 18 (1.29) Output: DC to 26.5 GHz: 20 (1.22) | Input: DC to 18 GHz: 20 (1.22) 18 to 26.5 GHz: 16 (1.38) 26.5 to 40 GHz: 14 (1.50) 40 to 50 GHz: 12 (1.65) Output: DC to 26.5 GHz: 18 (1.29) 26.5 to 40 GHz: 14 (1.50) 40 to 50 GHz: 12 (1.65) | Input: DC to 18 GHz: 18.6 (1.25) 18 to 26.5 GHz: 15.6 (1.43) 26.5 to 40 GHz: 14.0 (1.58) 40 to 50 GHz: 10.3 (1.79) 50 to 67 GHz: 8.5 (2.1) Output: DC to 18 GHz: 17.7 (1.33) 18 to 26.5 GHz: 14 (1.43) 26.5 to 40 GHz: 11.7 (1.58) 40 to 50 GHz: 9.5 (1.79) 50 to 67 GHz: 8.5 (2.1) |
| Amplitude tracking (dB), typical | DC to 100 MHz: 0.1 100 MHz to 2 GHz: 0.2 | DC to 4 GHz: 0.15 4 to 8 GHz: 0.20 8 to 18 GHz: 0.25 | DC to 18 GHz: 0.25 18 to 26.5 GHz: 0.40 | DC to 18 GHz: 0.30 18 to 26.5 GHz: 0.35 26.5 to 50 GHz: 0.40 | DC to 50 GHz: 0.40 50 to 67 GHz: 0.65 |
| Phase tracking (degree) typical | DC to 100 MHz: 1.0 100 MHz to 2 GHz: 3.0 | DC to 4 GHz: 0.5 4 to 8 GHz: 1.5 8 to 18 GHz: 3.0 | DC to 18 GHz: 1.5 18 to 26.5 GHz: 2.5 | DC to 18 GHz: 2.0 18 to 26.5 GHz: 2.5 26.5 to 50 GHz: 3.0 | DC to 50 GHz: 4.0 50 to 67 GHz: 7.0 |
| Max input power | +27 dBm | +27 dBm | +27 dBm | +27 dBm | + 30 dBm |

Connectors:

Type-N female on all ports

Option 001: Type-N male on the input and type-N female on the output ports

Option 002: Type-N female on the input and APC-7 on the output ports

Typical Performance

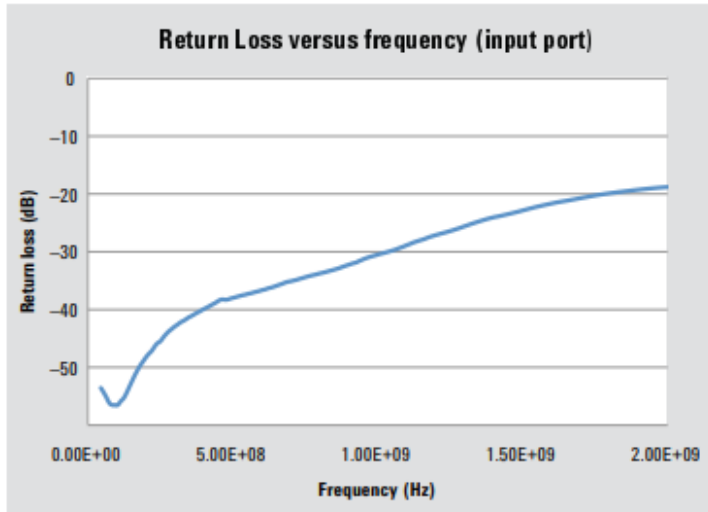

Figure 6. 11667L input port return loss versus frequency (typical)

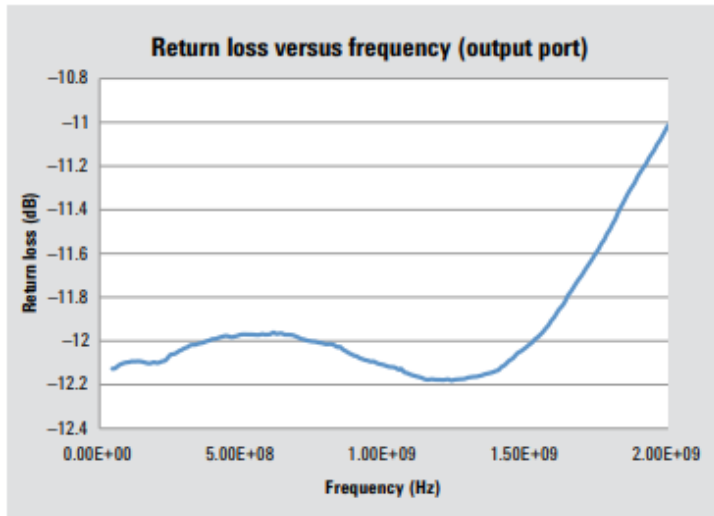

Figure 7. 11667L output port return loss versus frequency (typical)

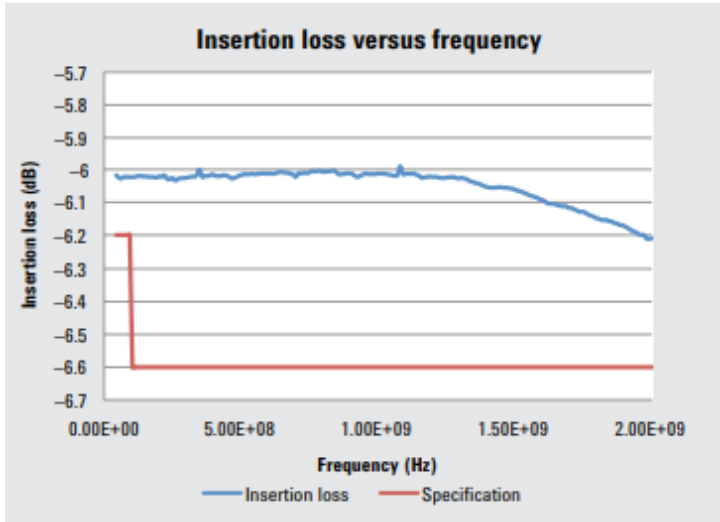

Figure 8. 11667L insertion loss versus frequency (typical)

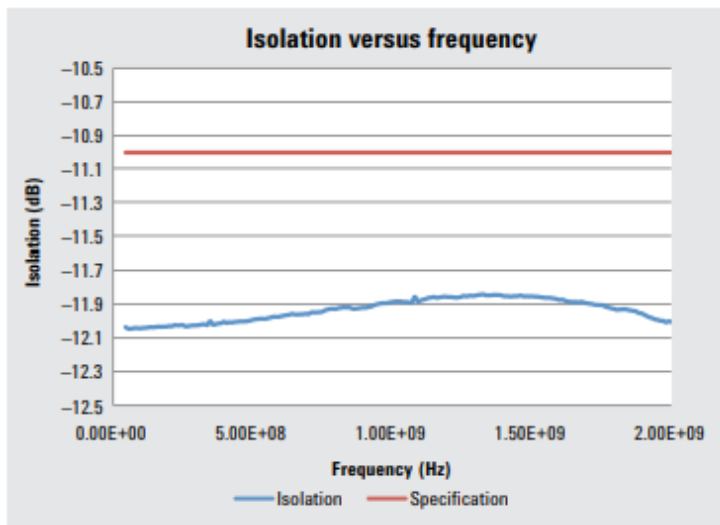

Figure 9. 11667L isolation versus frequency (typical)

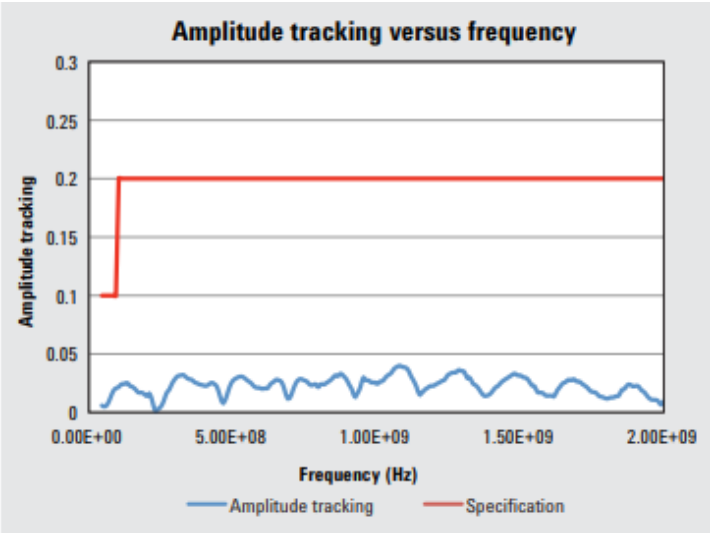

Figure 10. 11667L amplitude tracking (dB) versus frequency (typical)

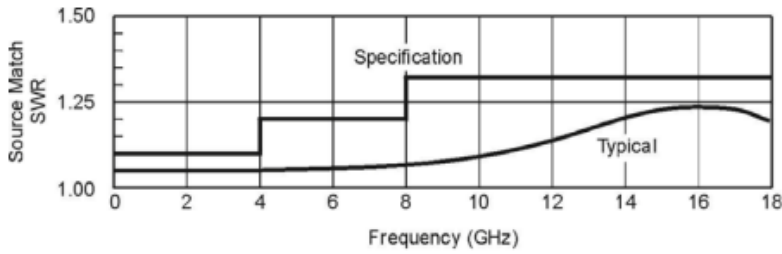

Figure 11. 11667A Leveling or ratio measurement source match (typical)

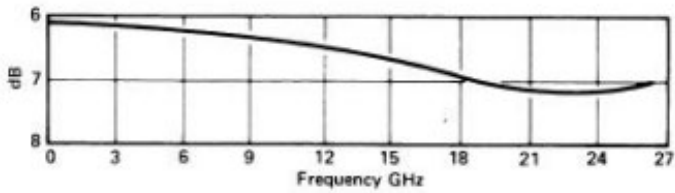

Figure 12. 11667B Insertion loss versus frequency (typical)

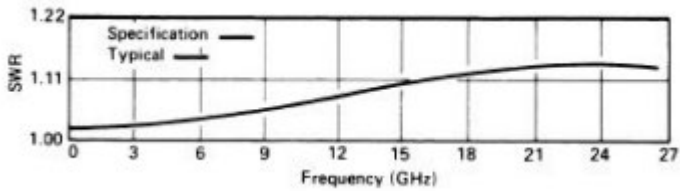

Figure 13. 11667B Leveling or ratio measurement source match (typical)

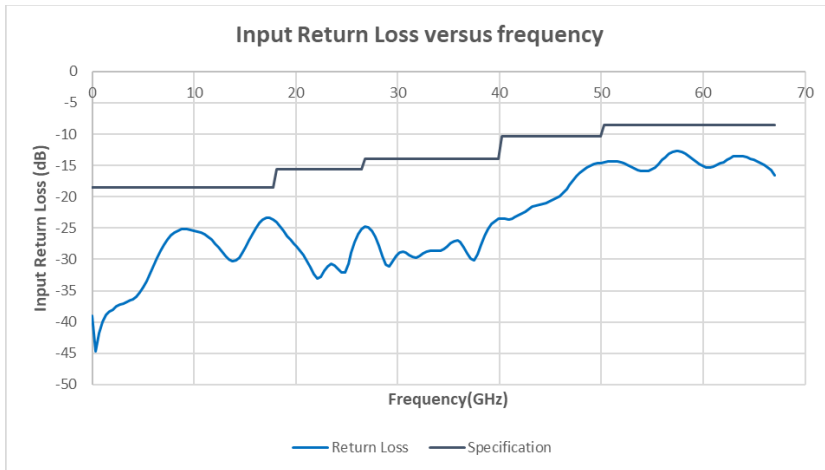

Figure 14. 11667D Input return loss versus frequency (typical)

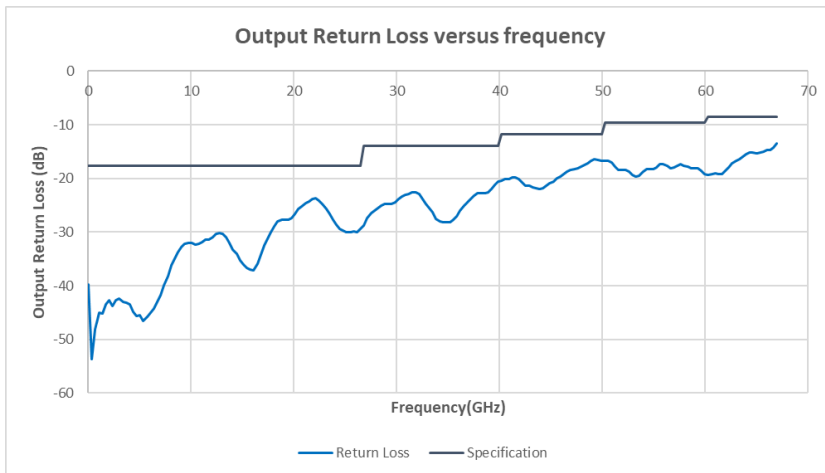

Figure 15. 11667D Output equivalent return loss versus frequency (typical)

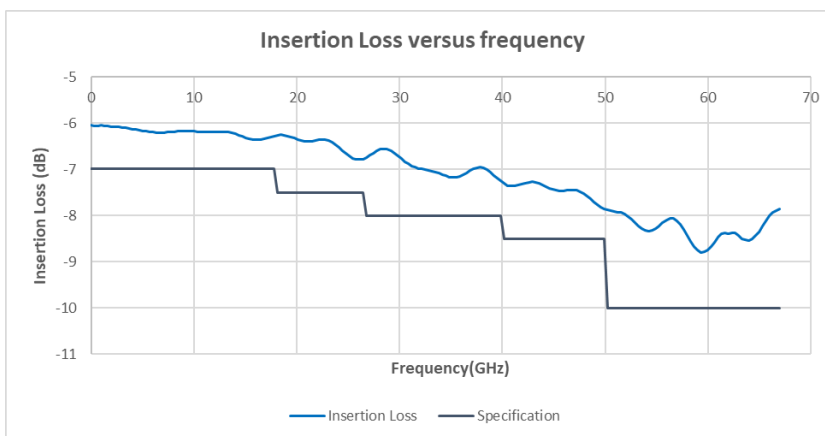

Figure 16. 11667D Insertion loss versus frequency (typical)

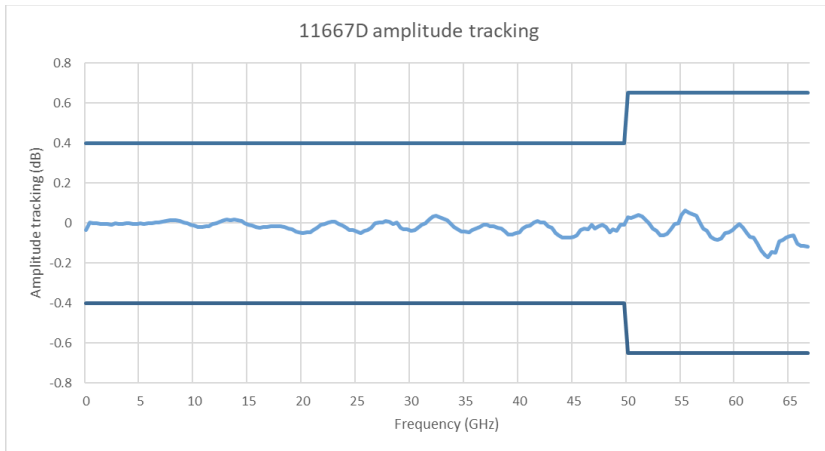

Figure 17. 11667D Amplitude tracking versus frequency (typical)

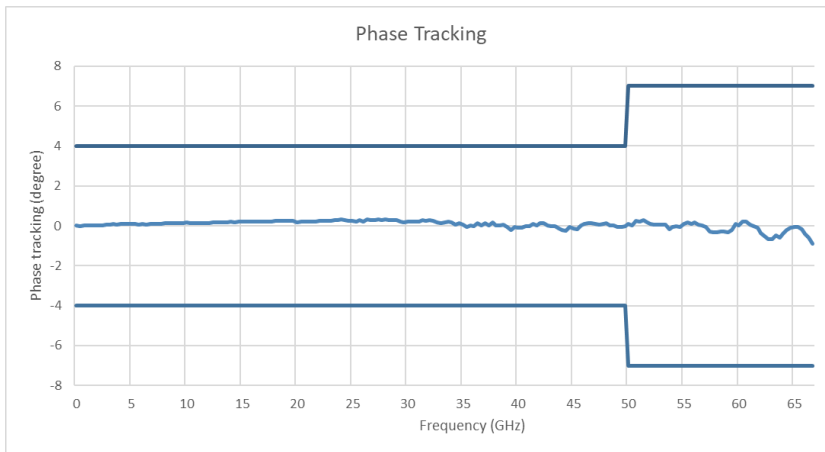

Figure 18. 11667D phase tracking versus frequency (typical)

Environmental Specifications

The 11667x power splitter are designed to fully comply with Keysight Technologies' product operating environment specifications. The following summarizes the environmental specifications for these products.

| Environmental condition | 11667L |
|-------------------------------------------------------------------|-----------------------------------------------------------------------------------|
| Temperature Operating Non-operating | 0 – 55 °C –40 °C to 70 °C |
| Humidity Non-operating Operating Functional shock | –10 °C to 25 °C / 50% RH 40 °C / 95% RH, 5-day cycle Half-sine, 30 g, 11 ms |
| Vibration Operating random vibration | 5 to 500 Hz, 0.21g RMS |
| Altitude Operating/storage | ≤ 4600 meters (15,000 feet) |
| ESD immunity Direct discharge Air discharge | 6kV 15kV |

| Environmental condition | 11667C |
|----------------------------------------------------------------------------|--------------------------------------------------------------------------------------------------------------------|
| Temperature Operating Non-operating | 0°C to +55°C -40°C to +75°C |
| Humidity Operating/storage | Up to 95% RH |
| Shock End-user handling Mechanical survival Transportation | Delta-V: 3m/s ±5%, Duration <3ms at 6 faces Half Sine: 1000g, 0.5ms at 6 faces 50g, delta-V: 8m/s at 6 faces |
| Vibration Operating random | 0.3 Grms, 5-500 Hz |
| Altitude Operating Storage and shipment | Up to 4,572 metres (15,000 feet) Up to 7,620 metres (25,000 feet) |

| | |
|----------------------------------------------------------|----------------------------------------------------------|
| ESD immunity Contac discharge Air discharge | 4 kV (to center conductor) 15 kV (to outer conductor) |
|----------------------------------------------------------|----------------------------------------------------------|

| Environmental condition | 11667D |
|----------------------------------------------------------------------------|--------------------------------------------------------------------------------------------------------------------------------------------------------------------------|
| Temperature Operating Storage Cycling | 0°C to +55°C -40°C to +75°C -40°C to +75°C, 10 cycles at 20 °C per minute ramp rate, 20 minutes dwell time per MIL-STD-833F, Method 1010.8, Condition C (modified) |
| Humidity Operating Condensation Resistance | 95% RH at 40°C, 24 hours cycling, 5 cycles 95% RH at -10°C to 25°C, Method 2 95% RH at 65°C, 10 Days per JEDEC HAST Standard |
| Shock End-user handling Mechanical survival Transportation | Delta-V: 3m/s ±5%, Duration <3ms at 6 faces Half Sine: 1000g, 0.5ms at 6 faces 50g, delta-V: 8m/s at 6 faces |
| Vibration Operating random | 0.3 Grms, 5-500 Hz |
| Altitude Operating Non-operating | 4,600 meters (15,092 feet) 4,600 meters (15,092 feet) |
| ESD immunity Contac discharge Air discharge | 4 kV (to center conductor) 15 kV (to outer conductor) |

Mechanical Dimensions

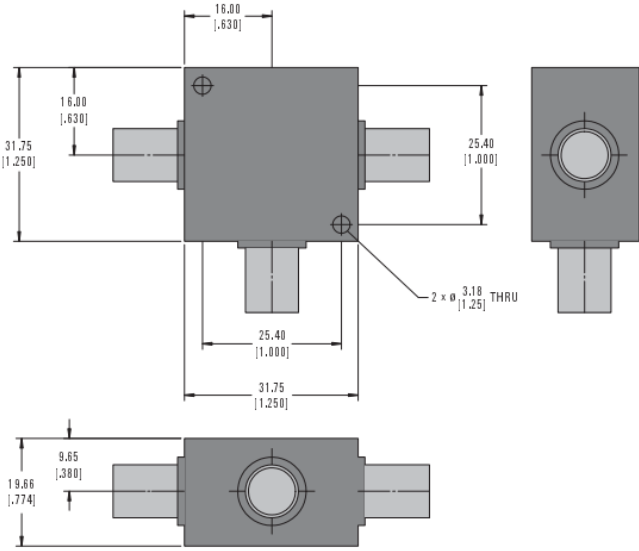

Figure 19. 11667L mechanical dimension

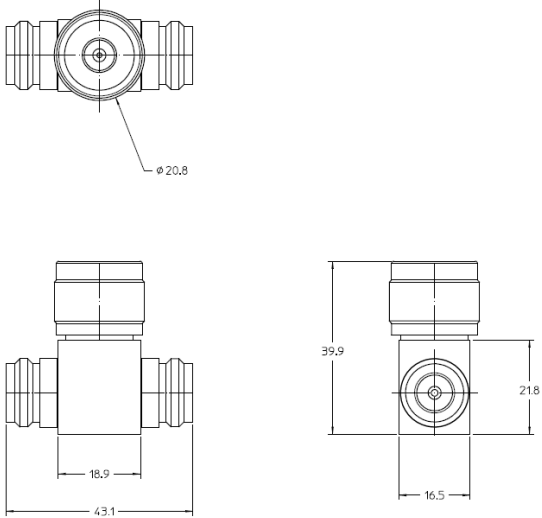

Figure 20. 11667A mechanical dimension

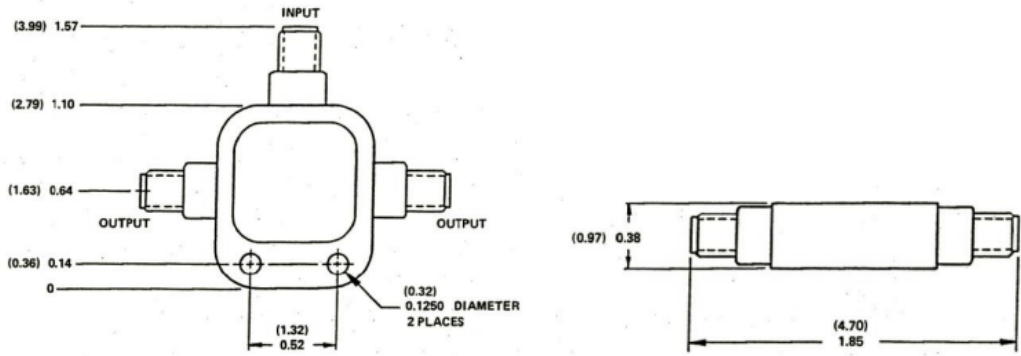

Figure 21. 11667B mechanical dimension

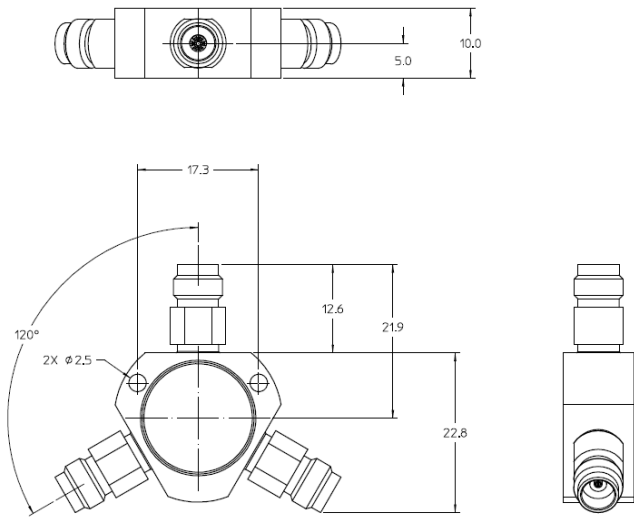

Figure 22. 11667C/D mechanical dimension

Ordering Information

| Model | Description |
|--------|------------------------------------------------------------------------------------------------------------------------------------------------------------------------------------|
| 11667L | Power splitter, DC to 2 GHz |
| 11667A | Power splitter, DC to 18 GHz Option 001: Type-N male on the input and type-N female on the output ports Option 002: Type-N female on the input and APC-7 on the output ports |
| 11667B | Power splitter, DC to 26.5 GHz |
| 11667C | Power splitter, DC to 50 GHz |
| 11667D | Power splitter, DC to 67 GHz |

More RF & Microwave Test Accessories

For selection of more than 300 models of various type of RF and microwave test accessories with operating frequency up to 110 GHz. Go to: www.keysight.com/find/mta

Learn more at: www.keysight.com

For more information on Keysight Technologies' products, applications or services, please contact your local Keysight office. The complete list is available at: www.keysight.com/find/contactus

