



Digital transistors (built-in resistors)

DTA124EE/DTA124EUA/DTA124ECA DTA124EKA/DTA124ESA

DIGITAL TRANSISTOR (PNP)

Features

- 1) Built-in bias resistors enable the configuration of an inverter circuit without connecting external input resistors (see equivalent circuit).
- 2) The bias resistors consist of thin-film resistors with complete isolation to allow negative biasing of the input. They also have the advantage of almost completely eliminating parasitic effects.
- 3) Only the on/off conditions need to be set for operation, making device design easy.

●Equivalent circuit

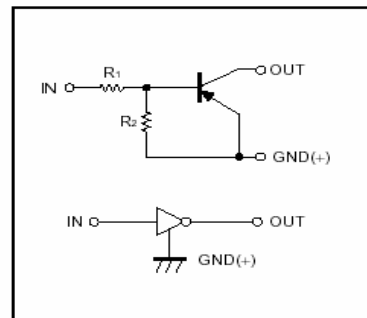

PIN CONNENCTIONS AND MARKING

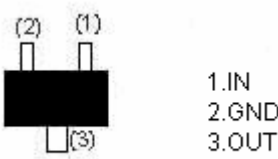
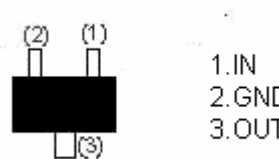
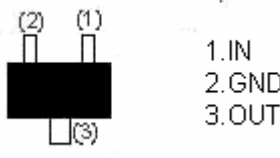
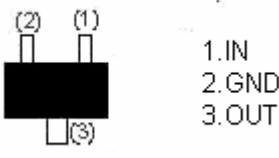
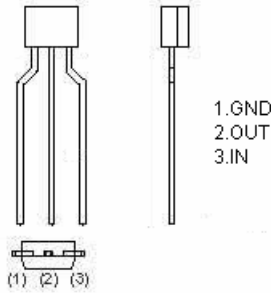
<p>DTA124EE</p>  <p>1.IN 2.GND 3.OUT</p> <p>SOT-523 Abbreviated symbol: 15</p>	<p>DTA124EUA</p>  <p>1.IN 2.GND 3.OUT</p> <p>SOT-323 Abbreviated symbol: 15</p>
<p>DTA124EKA</p>  <p>1.IN 2.GND 3.OUT</p> <p>SOT-23-3L Abbreviated symbol: 15</p>	<p>DTA124ECA</p>  <p>1.IN 2.GND 3.OUT</p> <p>SOT-23 Abbreviated symbol: 15</p>
<p>DTA124ESA</p>  <p>1.GND 2.OUT 3.IN</p> <p>TO-92S</p>	

Absolute maximum ratings(Ta=25°C)

Parameter	Symbol	Limits (DTA124E)					Unit
		E	UA	KA	CA	SA	
Supply voltage	V_{CC}	-50					V
Input voltage	V_{IN}	-40~10					V
Output current	I_O	-30					mA
	$I_{C(MAX)}$	-100					
Power dissipation	P_d	150		200		300	mW
Junction temperature	T_j	150					°C
Storage temperature	T_{stg}	-55~150					°C

Electrical characteristics (Ta=25°C)

Parameter	Symbol	Min.	Typ	Max.	Unit	Conditions
Input voltage	$V_{I(off)}$			-0.5	V	$V_{CC}=-5V, I_O=-100\mu A$
	$V_{I(on)}$	-3				$V_O=-0.2V, I_O=-5mA$
Output voltage	$V_{O(on)}$			-0.3	V	$I_O/I_I=-10mA/-0.5mA$
Input current	I_I			-0.36	mA	$V_I=-5V$
Output current	$I_{O(off)}$			-0.5	μA	$V_{CC}=-50V, V_I=0$
DC current gain	G_I	56				$V_O=-5V, I_O=-5mA$
Input resistance	R_I	15.4	22	28.6	K Ω	
Resistance ratio	R_2/R_1	0.8	1	1.2		
Transition frequency	f_T		250		MHz	$V_O=-10V, I_O=-5mA, f=100MHz$

Typical Characteristics

DTA124EE/EUA/EKA/ESA/ECA

●Electrical characteristic curves

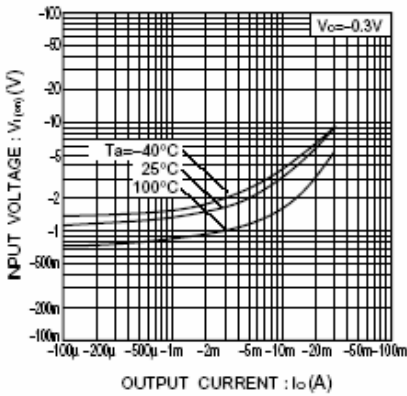

Fig.1 Input voltage vs. output current (ON characteristics)

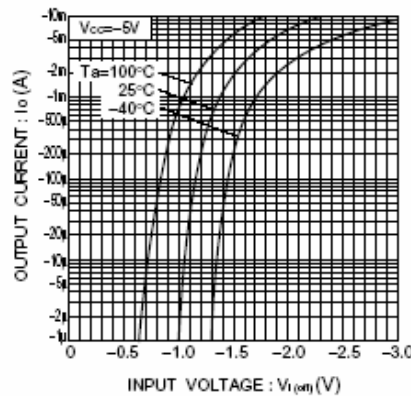

Fig.2 Output current vs. input voltage (OFF characteristics)

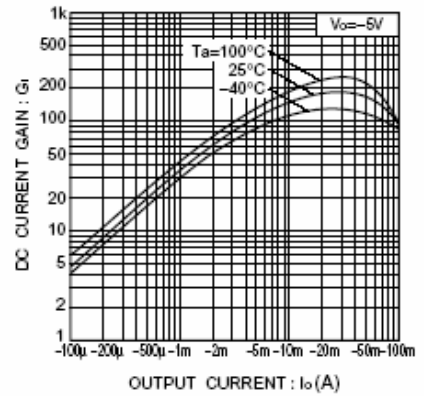

Fig.3 DC current gain vs. output current

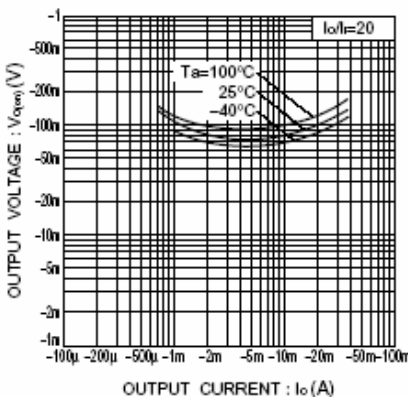

Fig.4 Output voltage vs. output current