

DETAILS

Product Number	CA12079_HEIDI-W2
Family	Heidi
Type	Assembly
Color	clear
Diameter	21.6 mm
Height	12 mm
Style	round
Optic Material	PMMA
Holder Material	
Fastening	pin, tape
Status	ready
ROHS Compliant	Yes
Date Updated	25/09/2013



OPTICAL PROPERTIES

LED	Viewing Angle	Light Beam	Efficiency	cd/lm	Connector
NCSxx19A	sim:	W2	79 %	-	-
Oslo Square EC	sim: 48	W2	-	sim: 1.600	-
Oslo SSL 150	40 deg	W2	81 %	1.210	-
LUXEON TX	44 deg	W2	78 %	1.300	-
NVSxx19B/NVSxx19C	44 deg	W2	77 %	1.200	-
Z5M1/Z5M2	44 deg	W2	83 %	1.320	-
XP-G	44 deg	W2	81 %	1.110	-
XP-L	44 deg	W2	79 %	1.260	-
XP-E	44 deg	W2	81 %	1.130	-
Double Dome (GM2BB)	44 deg	W2	-	-	-
LUXEON T	44 deg	W2	83 %	1.300	-
Z5	44 deg	W2	76 %	1.240	-
XP-E2	45 deg	W2	81 %	1.400	-
NCSxx19B	45 deg	W2	78 %	1.300	-
XB-H	45 deg	W2	80 %	1.200	-
XB-D	46 deg	W2	76 %	1.020	-
LH351Z	46 deg	W2	82 %	1.300	-
XP-G2	46 deg	W2	80 %	1.300	-
Oslo SSL 80	47 deg	W2	80 %	1.000	-
NVSxx19A	48 deg	W2	79 %	0.910	-
LUXEON Rebel	49 deg	W2	85 %	0.966	-

Relative intensity of CA12079_HEIDI-W2_(XB-H)

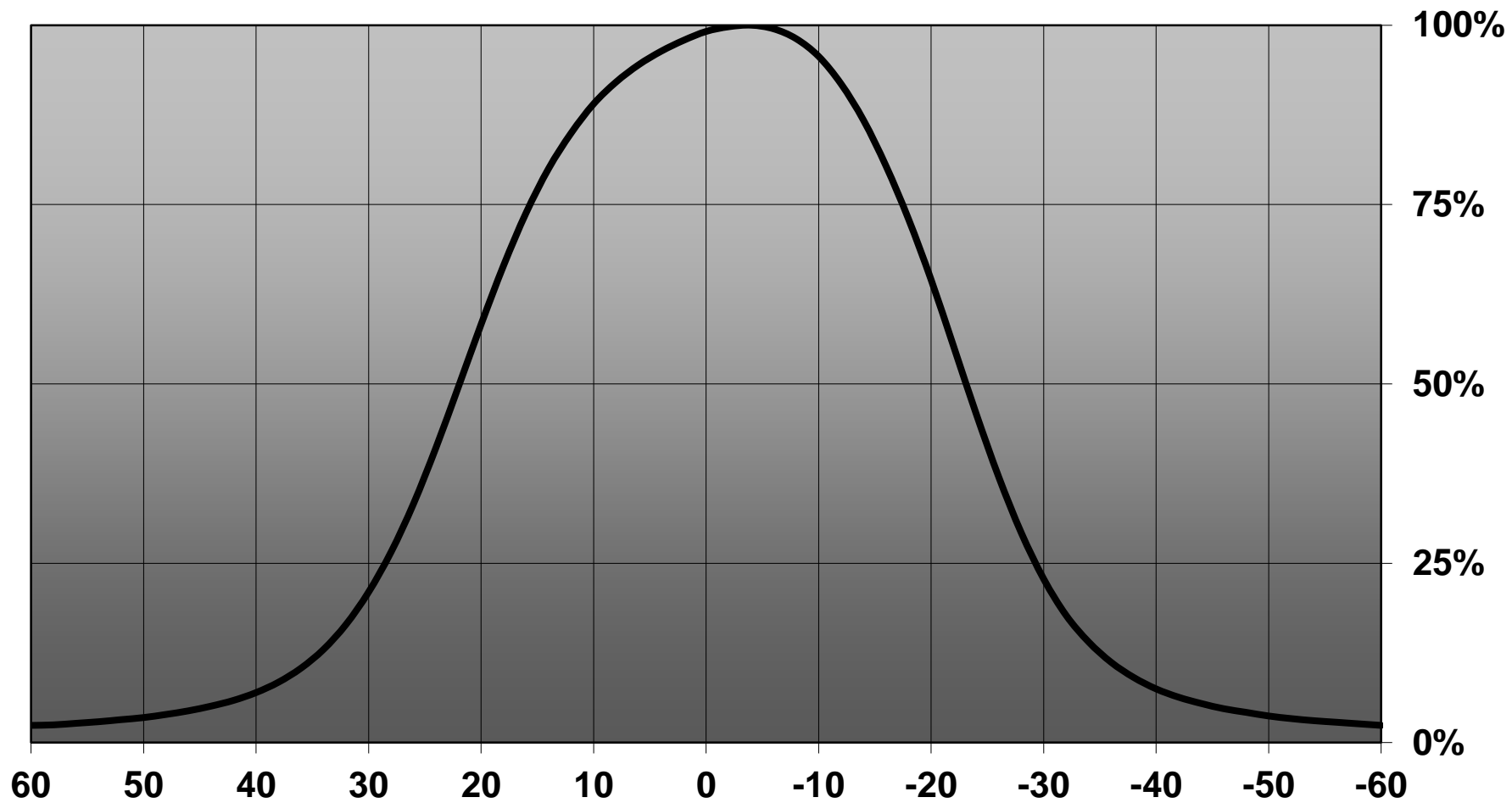

— C1 0-180

Relative intensity of CA12079_Heidi-W2-RE

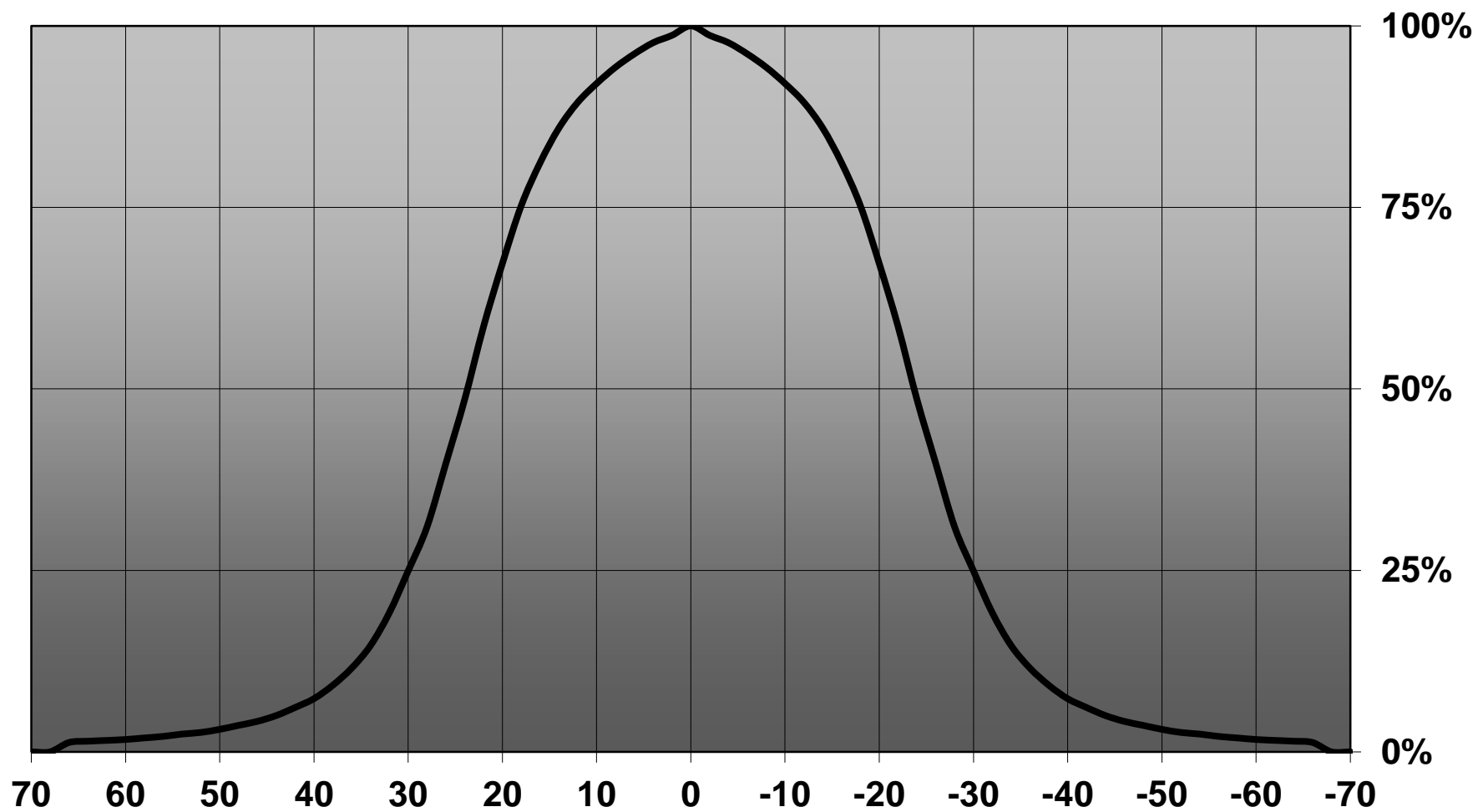

D

C

B

A

4

4

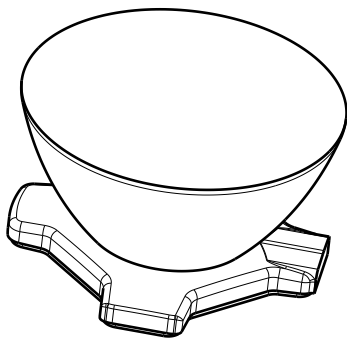

Isometric view

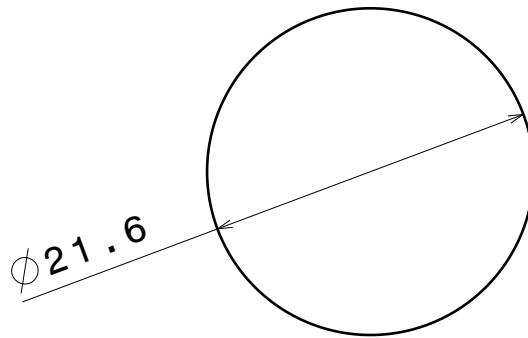

Top view

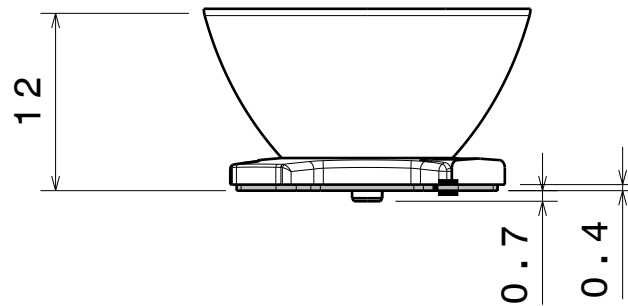

Front view

3

3

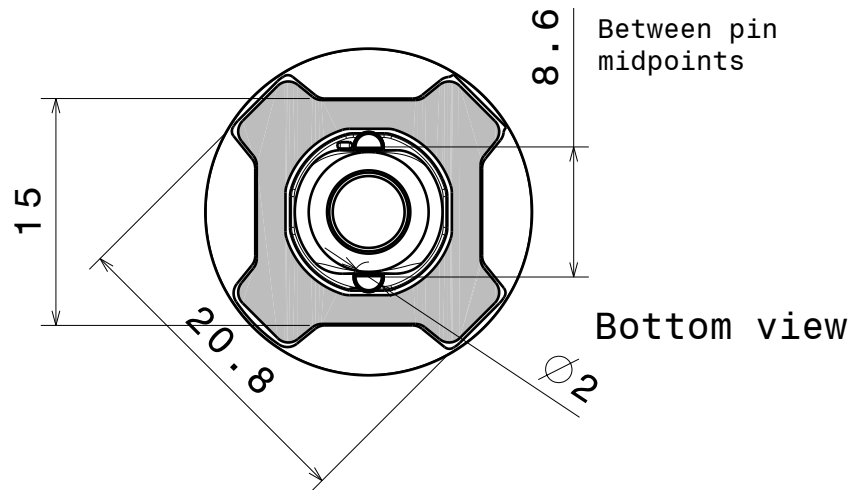

Bottom view

2

2

Material:
 Lens PMMA
 Tape PU Foam

Part no.s:
 CA11264_Heidi-D
 CA11265_Heidi-M
 CA11266_Heidi-O
 CA11267_Heidi-O-90

Tolerances if not otherwise shown
 According to DIN ISO 2768-1
 Linear measures:
 Up to 30mm class M, otherwise class C.
 According to DIN ISO 2768-2
 Form and position: class L

LEDiL LediL Oy
 Salorankatu 10
 FIN 24240 SALO
 Finland

1

1

THIRD ANGLE PROJECTION:

DRAWING TITLE
Datasheet_Heidi-W2

This drawing is the property of LEDiL Oy. It may not be reproduced, copied or communicated without a written agreement with LEDiL Oy."

SIZE	PART NUMBER
A4	

SCALE	1:1	WEIGHT	(g)	SHEET	1/1
-------	-----	--------	-----	-------	-----

D

A

Ledil Oy CA12079_Heidi-W2-OSL150 LOR=81% / LDC (Linear)

Luminaire: Ledil Oy CA12079_Heidi-W2-OSL150 LOR=81%
Lamps: 1 x Osram OSL150 109lm 150mA

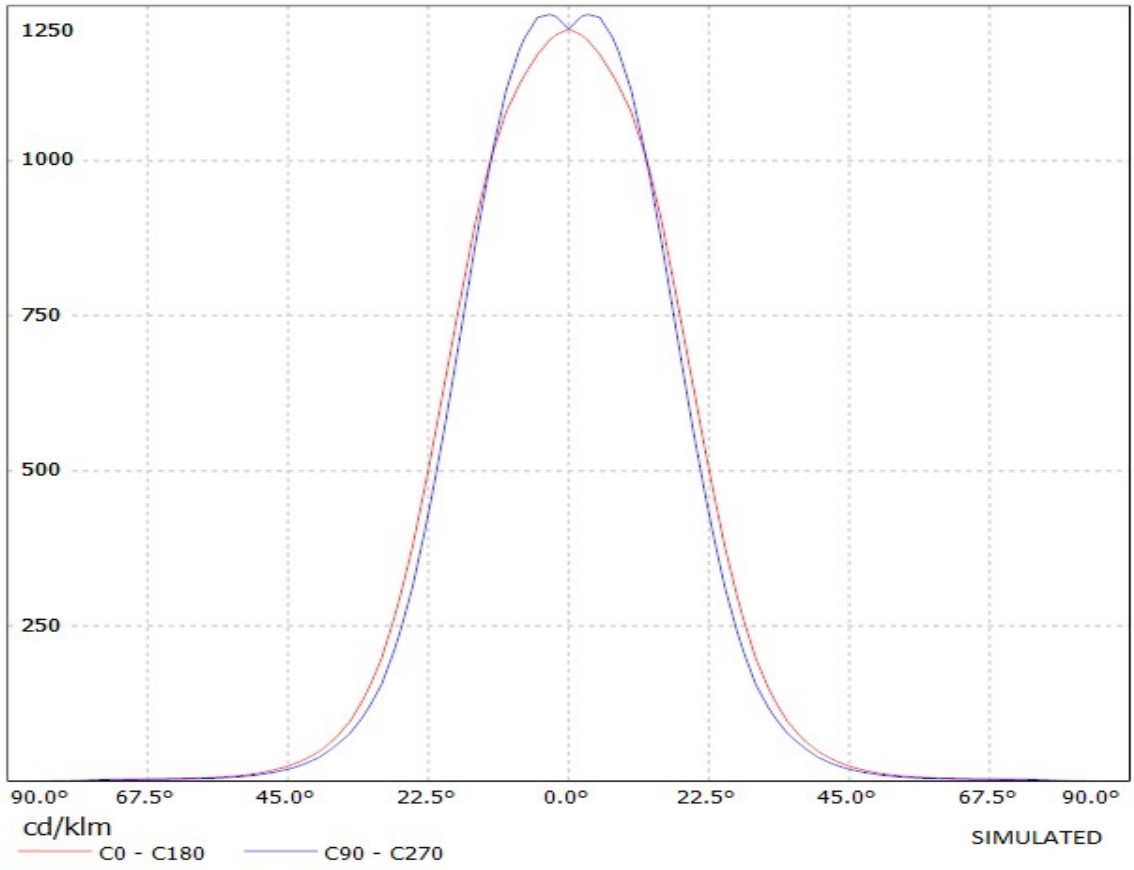

Luminaire: Ledil Oy CA12079_HEIDI-W2_(Luxeon_TX) Efficiency=78%
Lamps: 1 x Luxeon TX (L1T2-3585) 108lm @ 250mA CCT=3521K P=0.73W I=250mA

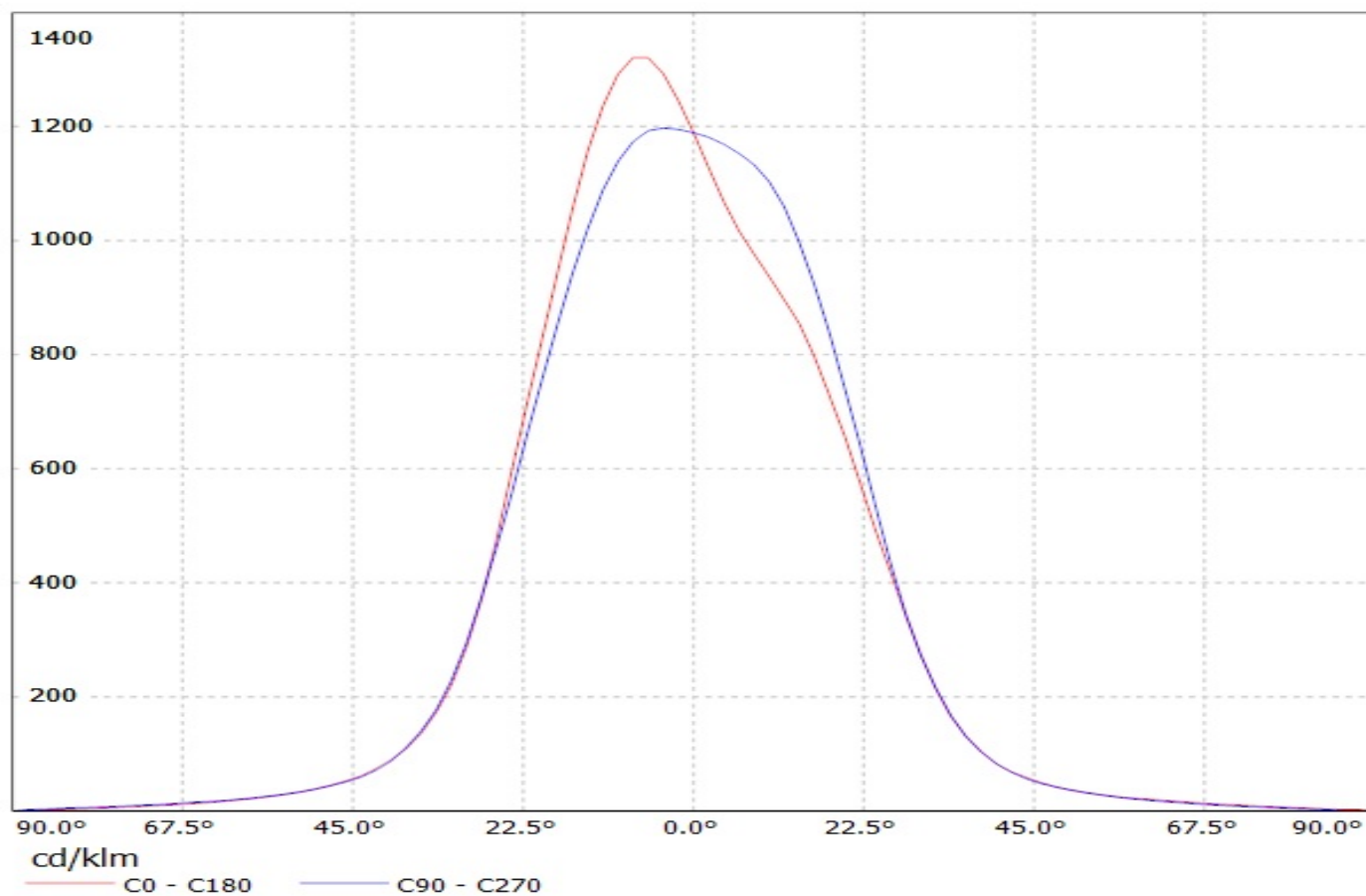

Luminaire: Ledil Oy CA12079_HEIDI-W2 (Nichia 219B 109lm @ 250mA) Efficiency=77%
Lamps: 1 x Nichia 219B 109lm @ 250mA

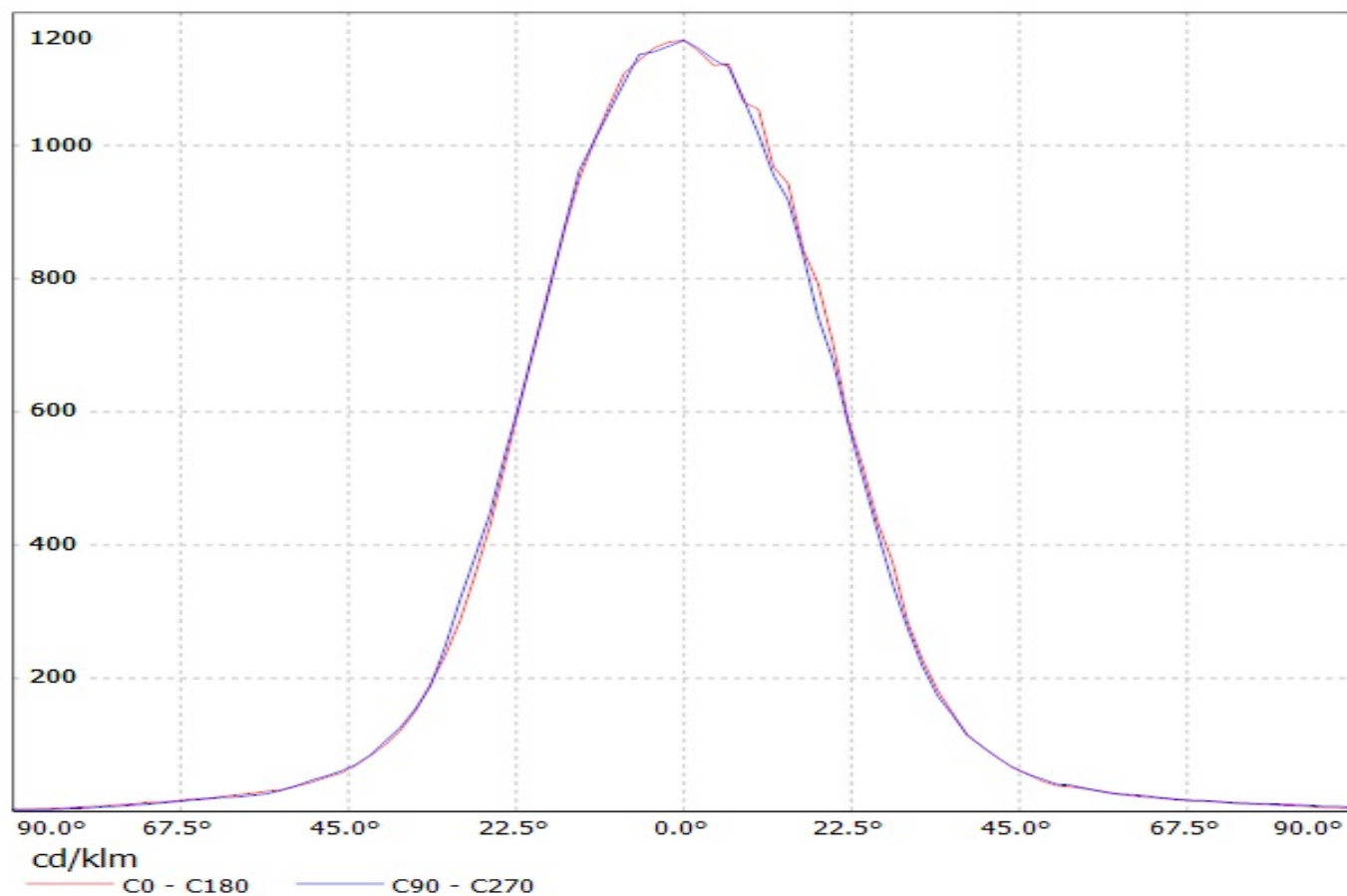

Luminaire: LEDiL Oy CA12079_HEIDI-W2_(Seoul_Z5M1)
Lamps: 1 x Seoul_Z5M1_107.648lm@250mA_CCT=9074K_P=0.739754W_I=249.9mA

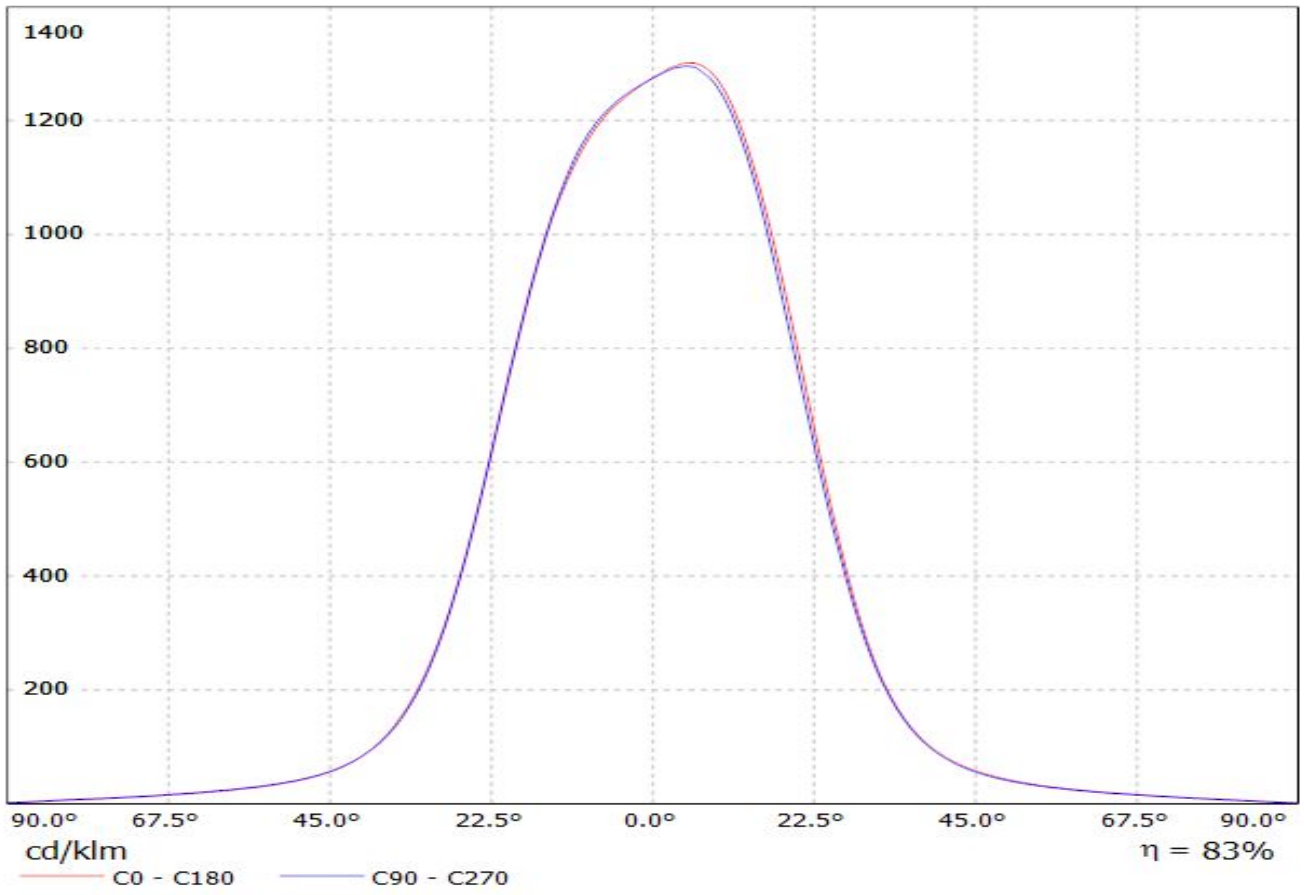

Luminaire: LEDiL Oy CA12079_HEIDI-W2 (XP-L) Eff.79.1%
Lamps: 1 x Cree_XP-L_127.813lm@250mA_P=0.73723W_I=249.9mA

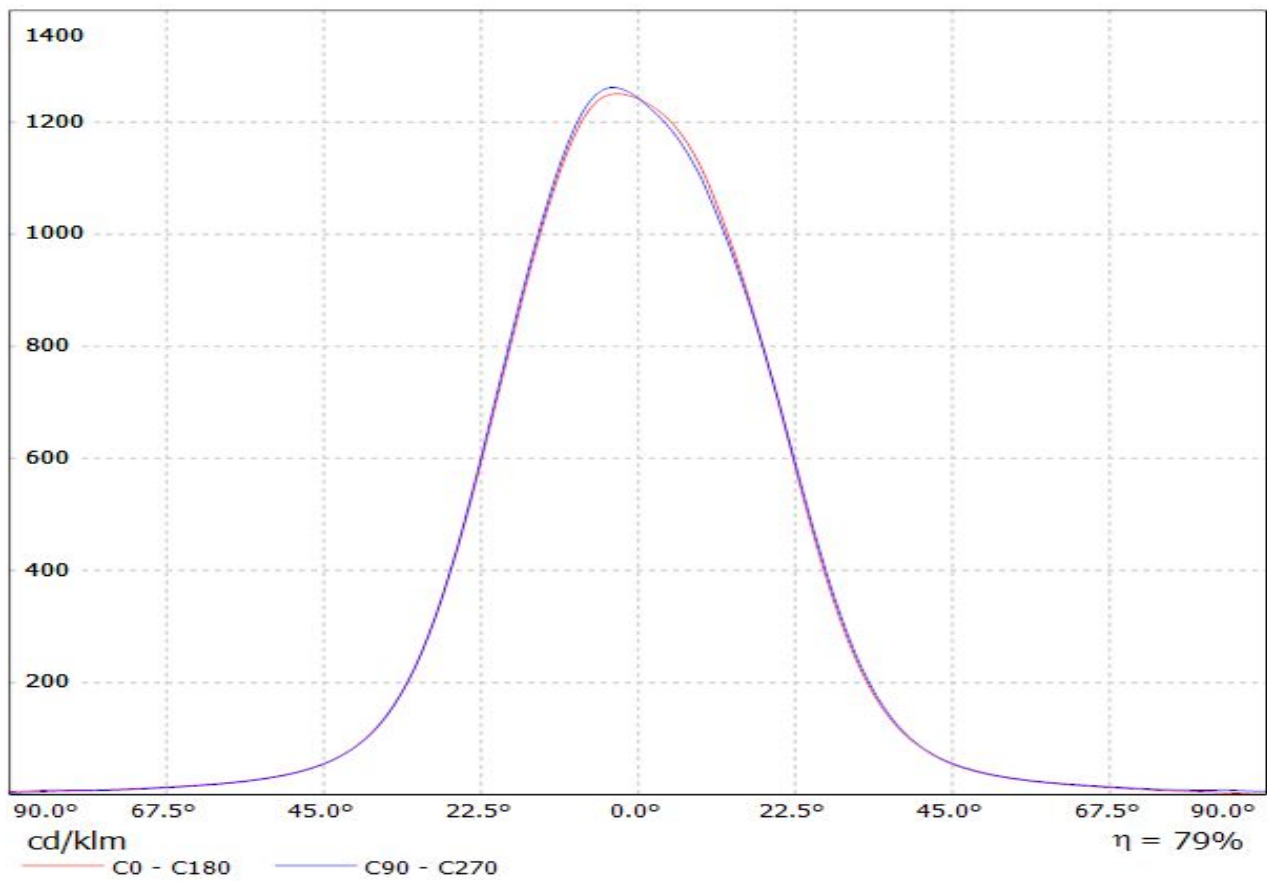

Ledil Oy CA12079_Heidi-W2-XP LOR= 81% / LDC (Linear)

Luminaire: Ledil Oy CA12079_Heidi-W2-XP LOR= 81%
Lamps: 1 x Cree XP-E 72lm 250mA

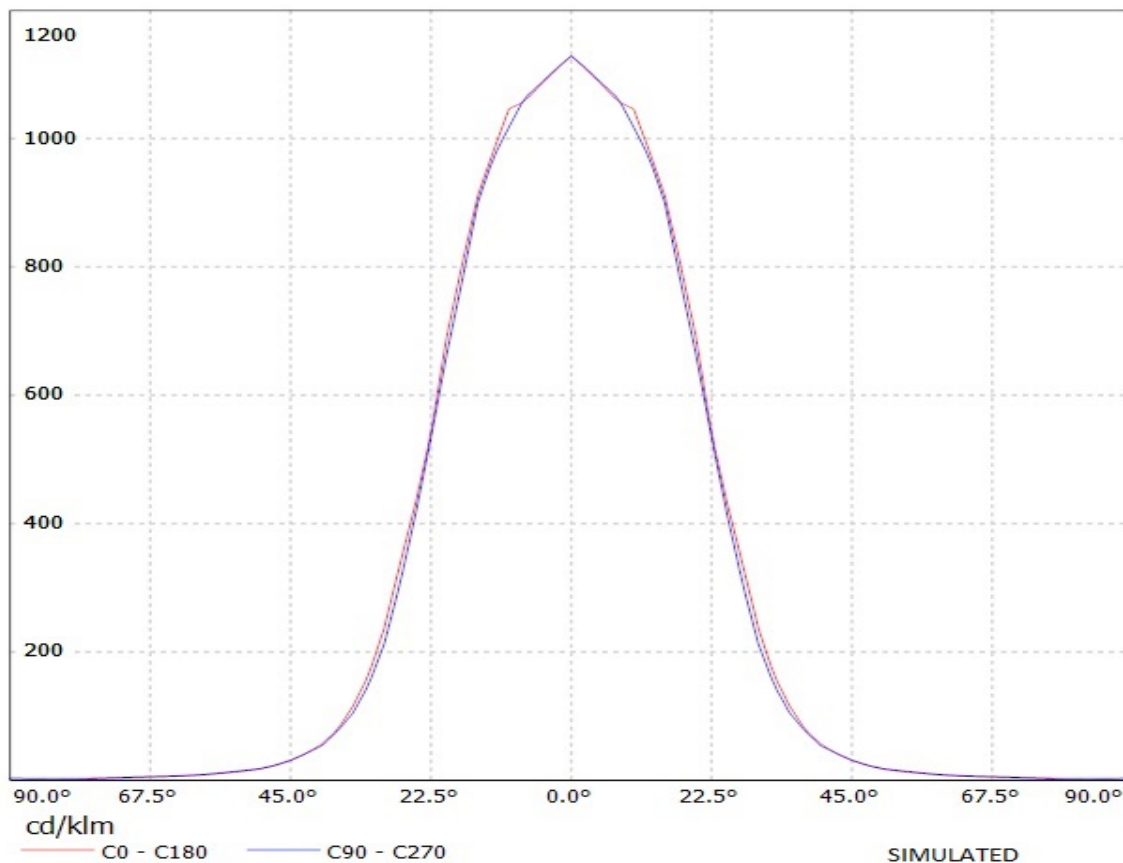

Luminaire: LEDiL Oy CA12079_HEIDI-W2_(LUXEON_T) Eff.83%
Lamps: 1 x LUXEON T (70lm@250mA)

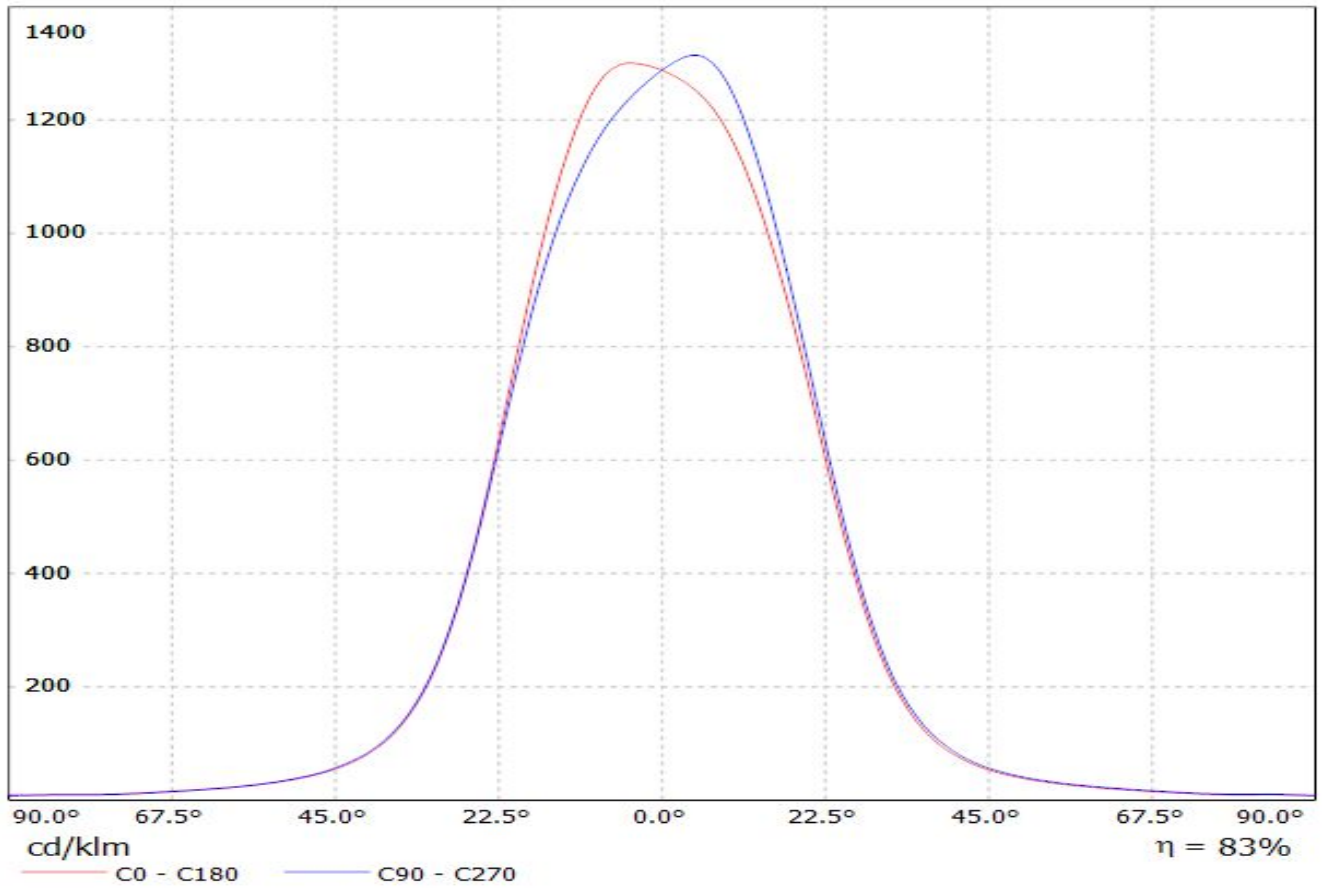

Luminaire: Ledil Oy CA12079 HEIDI-W2_(XP-E2) Efficiency=81%
Lamps: 1 x Cree XP-E2 (92lm @ 250mA) CCT=5500K P=0.8W I=250mA

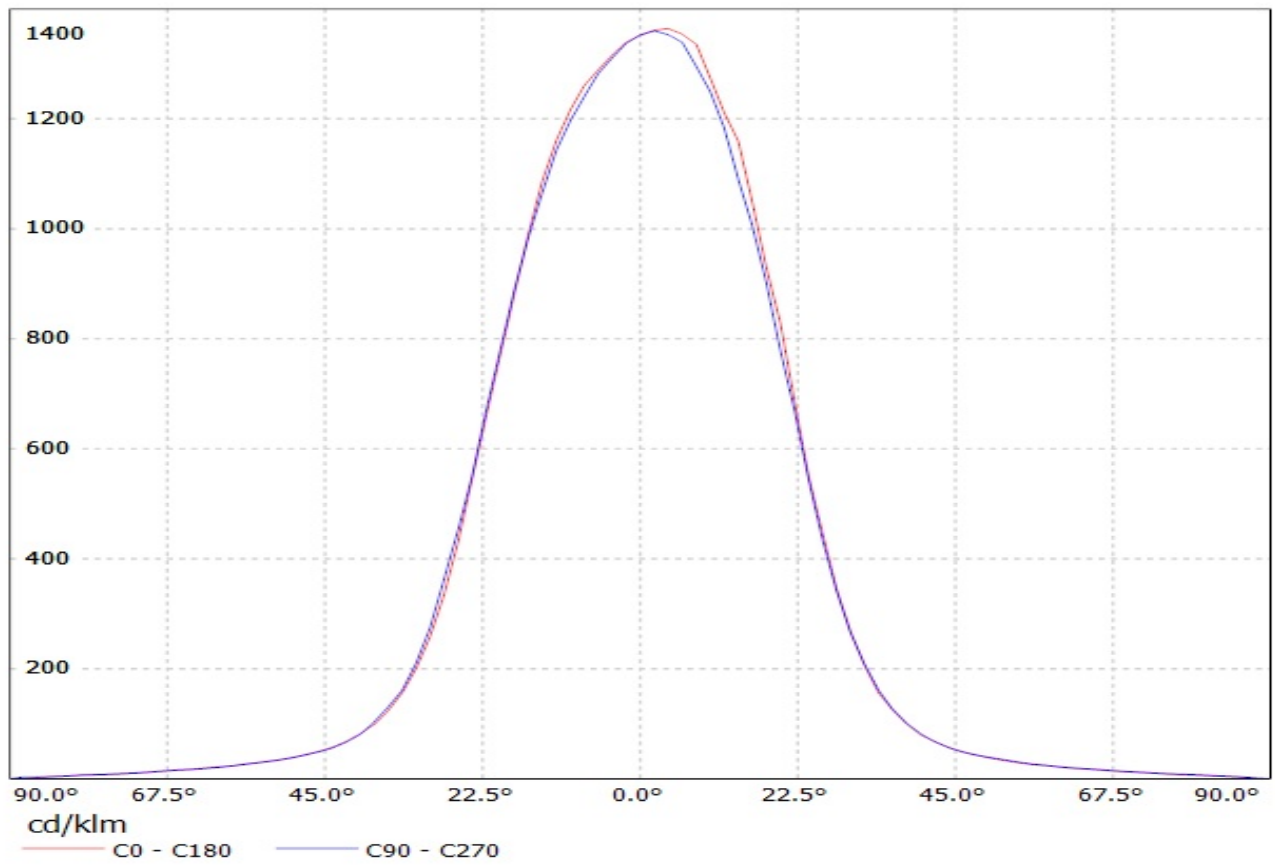

Luminaire: Ledil Oy CA12079_HEIDI-W2_(NCSxx19B) Efficiency=78%
Lamps: 1 x Nichia NCSxx19B (NCSL119BE) 88lm @ 250mA CCT=3000K P=0.8W I=250mA

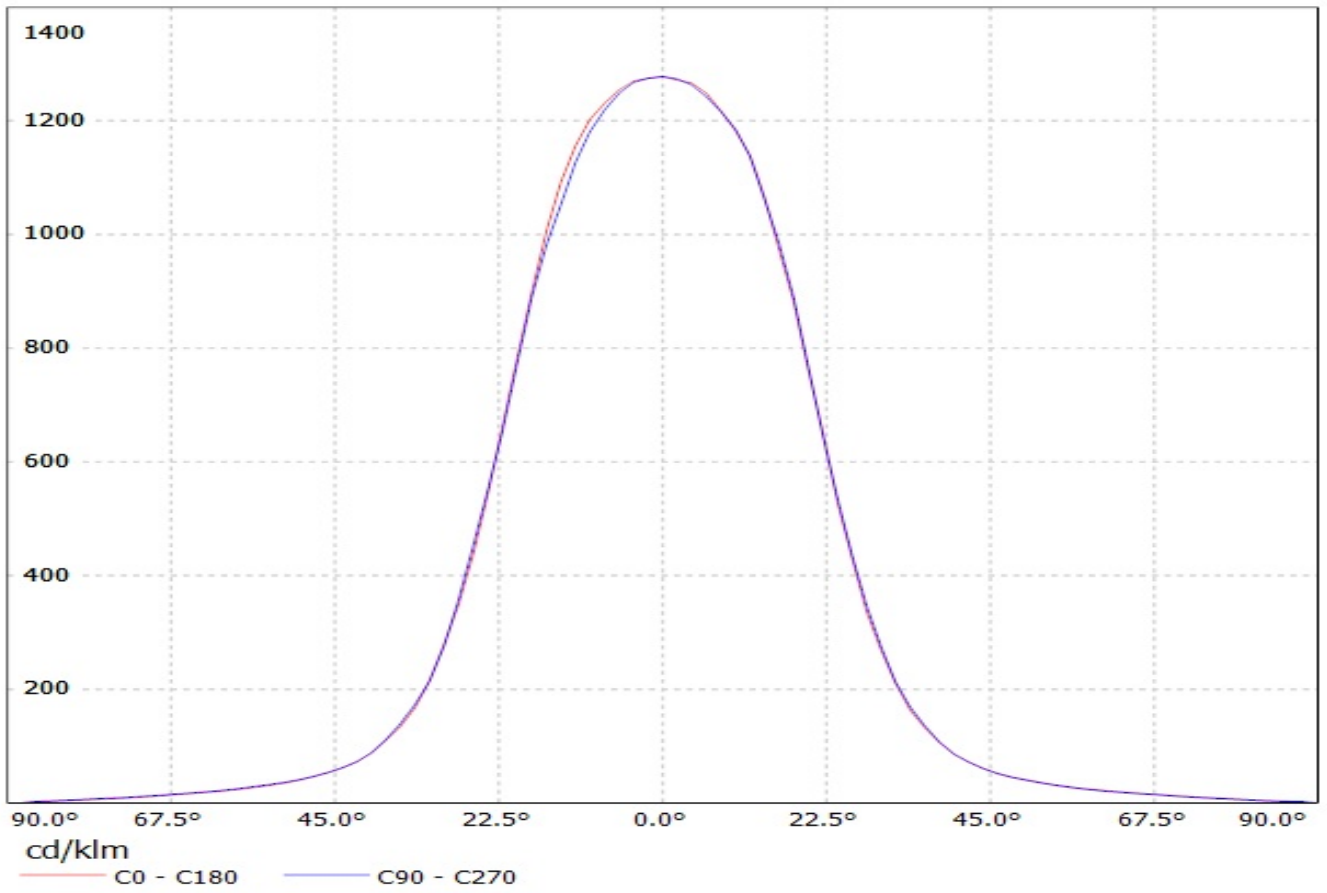

Luminaire: Ledil Oy CA12079_HEIDI-W2_(LH351Z) Efficiency=82%
Lamps: 1 x Samsung LH351Z (90.14lm @ 250mA) CCT=6500K P=0.7W I=250mA

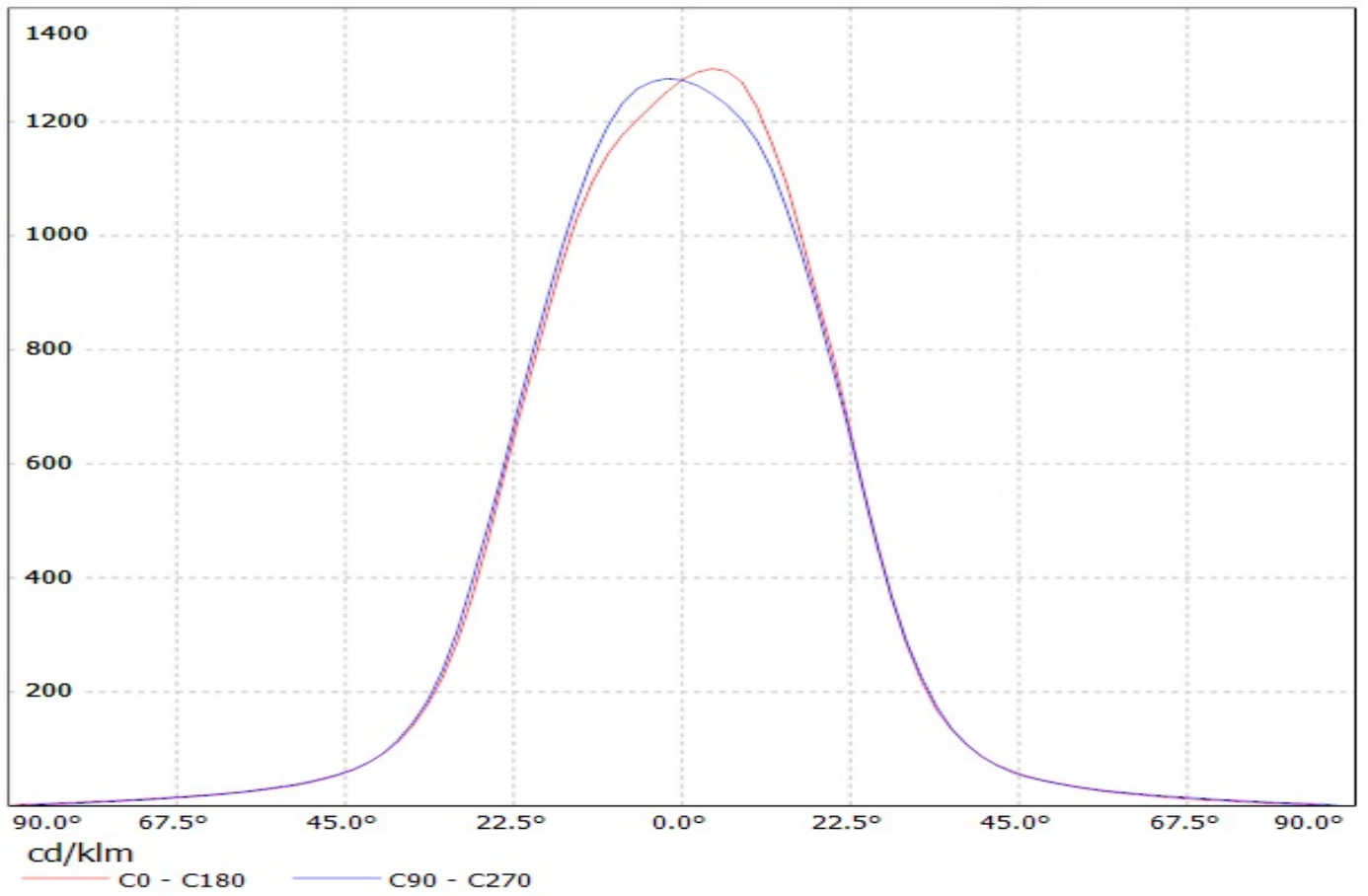

Luminaire: LEDil Oy CA12079_HEIDI-W2_(XP-G2) Efficiency=80%
Lamps: 1 x Cree XP-G2 (103lm @ 250mA) CCT=6600K P=0.7W I=250mA

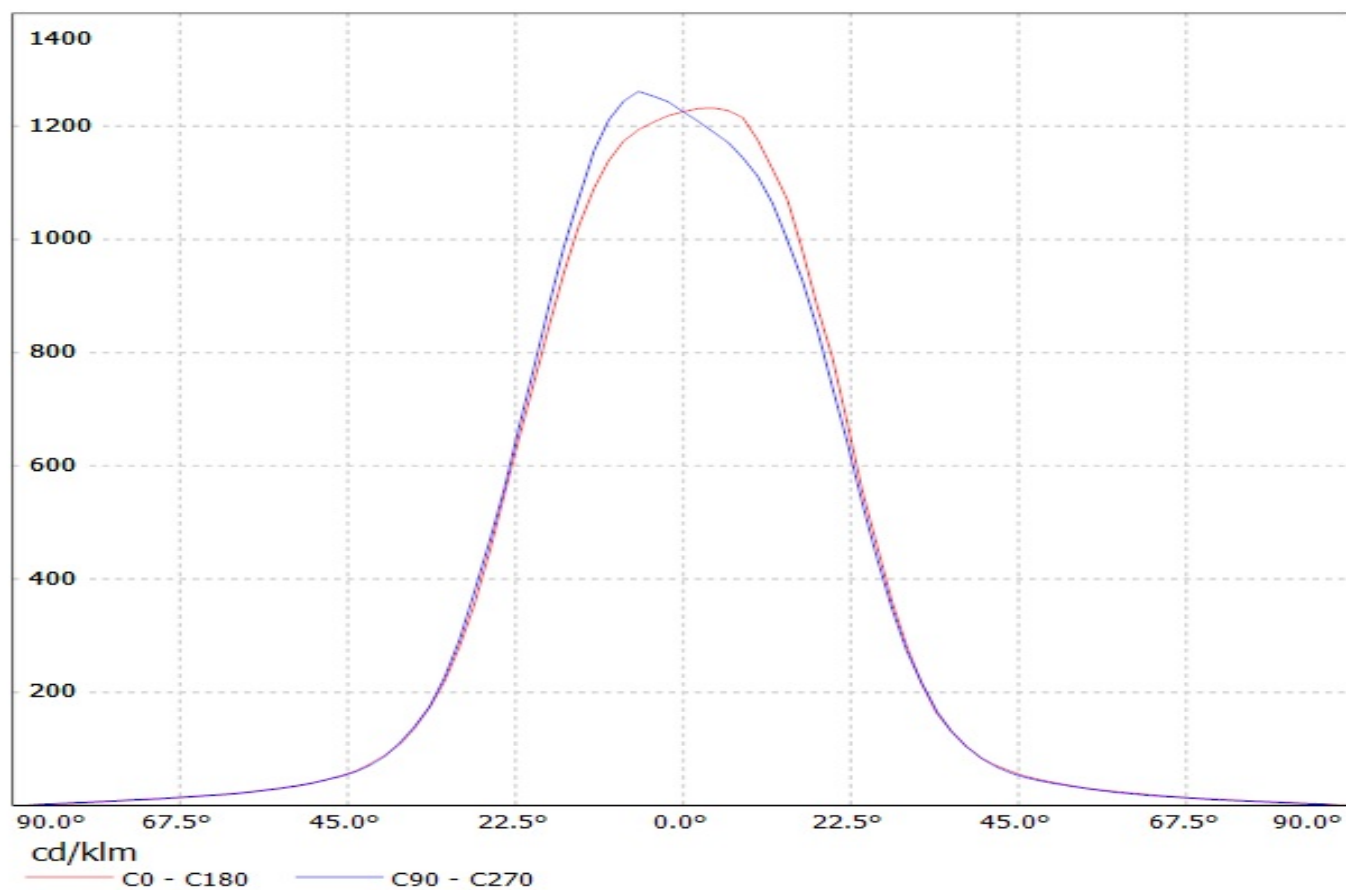

Ledil Oy CA12079_Heidi-W2-OSL LOR=80% / LDC (Linear)

Luminaire: Ledil Oy CA12079_Heidi-W2-OSL LOR=80%
Lamps: 1 x Osram OSL80 250mA 85lm

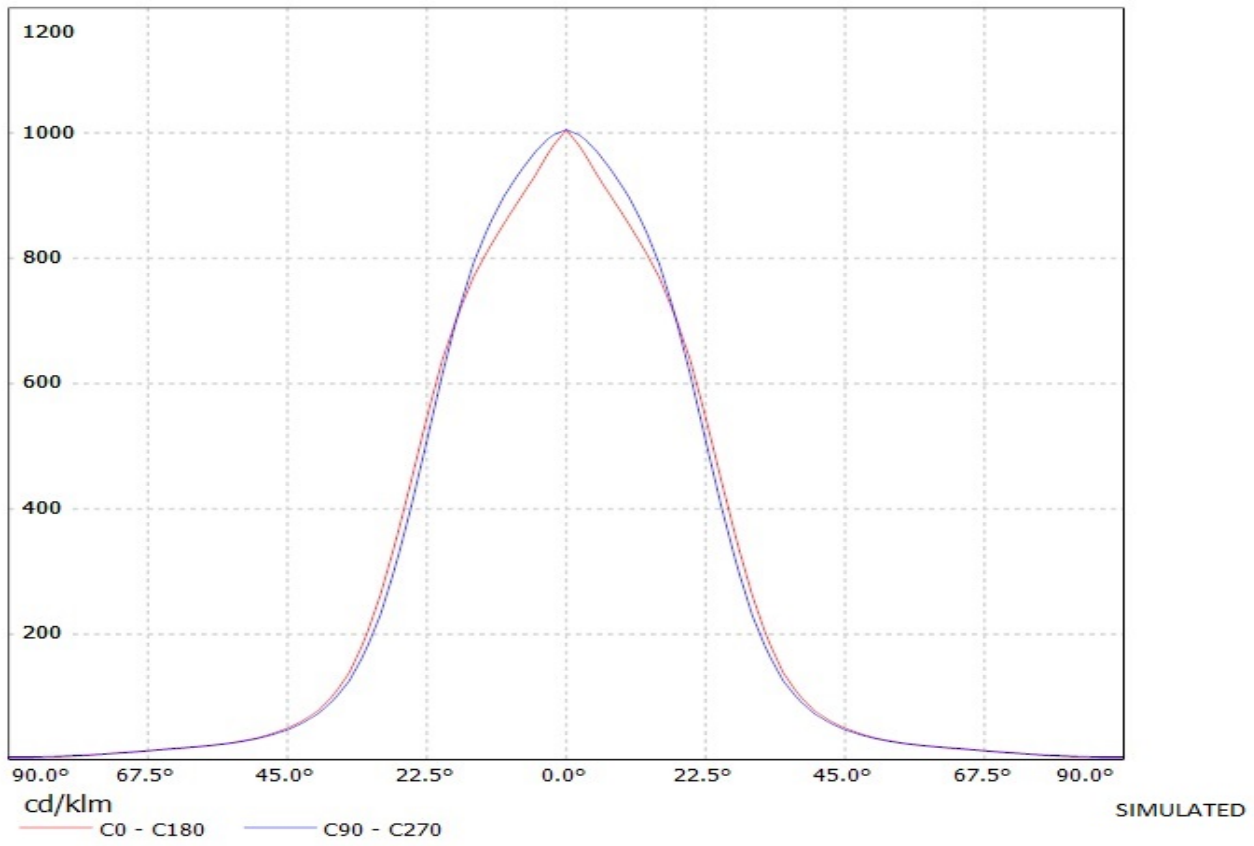

Luminaire: Ledil Oy CA12079_Heidi-W2-RE LOR=85%
Lamps: 1 x Luxeon Rebel 250mA 84lm

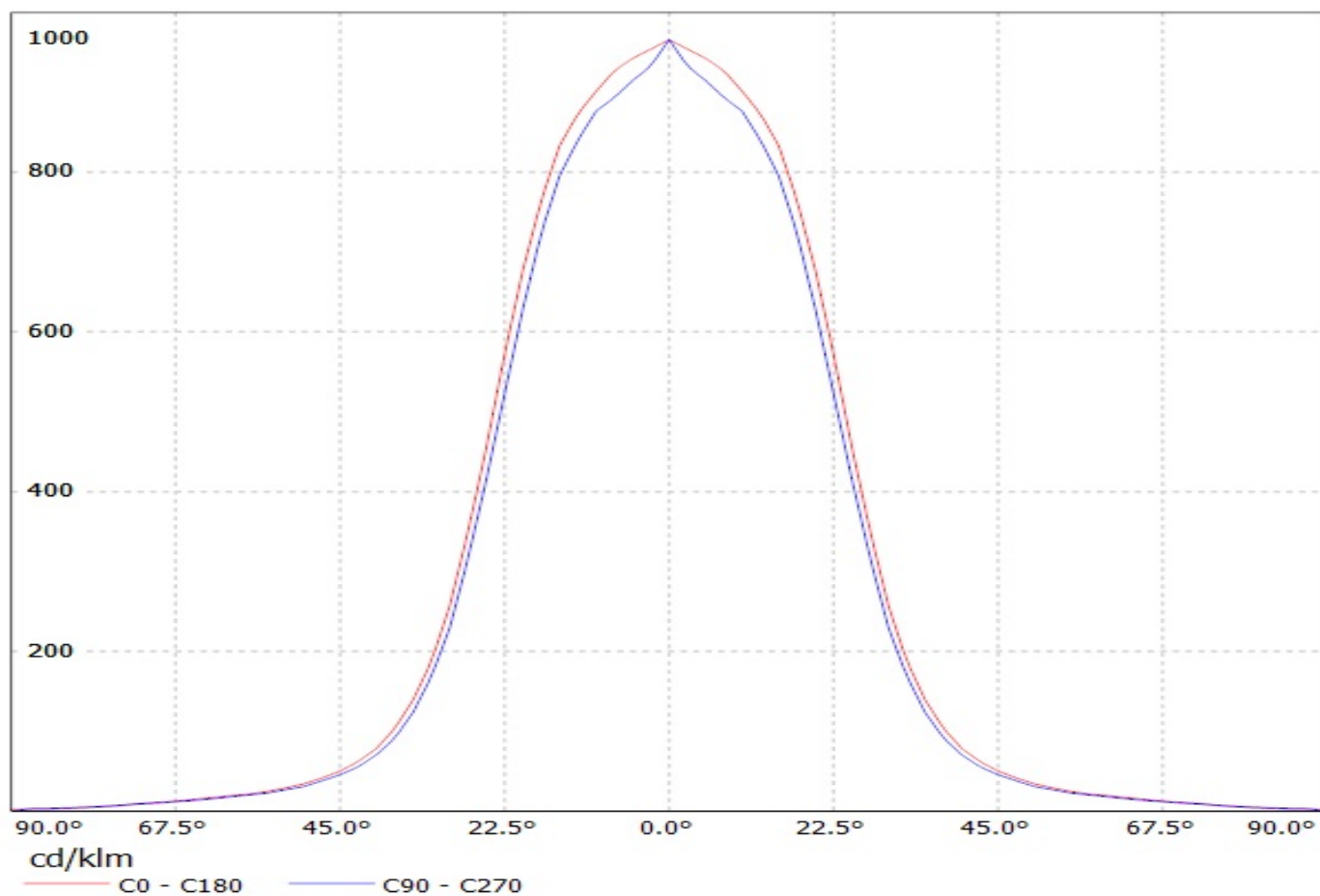

Ledil Oy CA12079_Heidi-W2-OSL150 LOR=81% / LDC (Polar)

Luminaire: Ledil Oy CA12079_Heidi-W2-OSL150 LOR=81%

Lamps: 1 x Osram OSL150 109lm 150mA

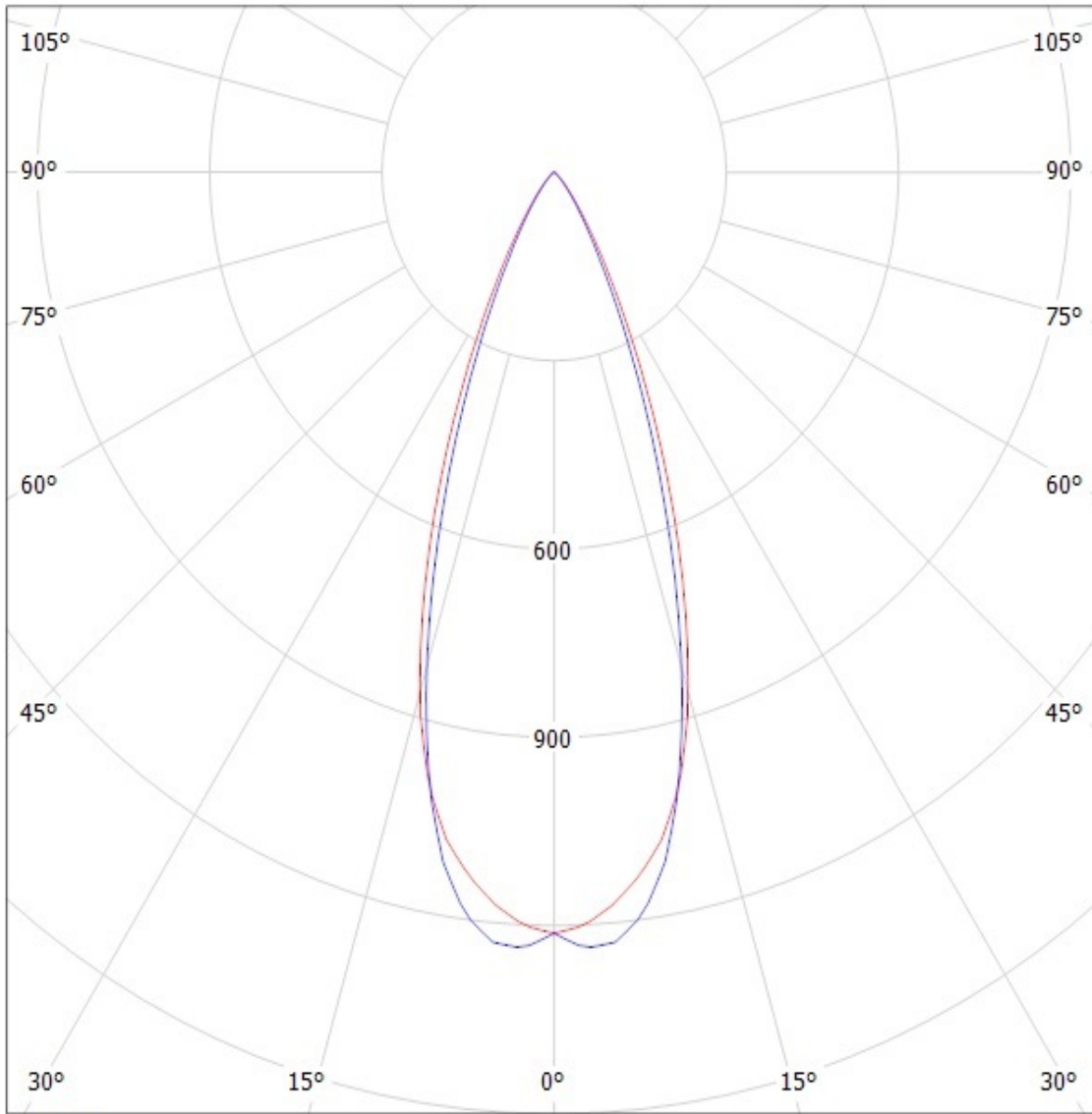

cd/klm

— C0 - C180

— C90 - C270

SIMULATED

Luminaire: Ledil Oy CA12079_HEIDI-W2_(Luxeon_TX) Efficiency=78%
Lamps: 1 x Luxeon TX (L1T2-3585) 108lm @ 250mA CCT=3521K P=0.73W I=250mA

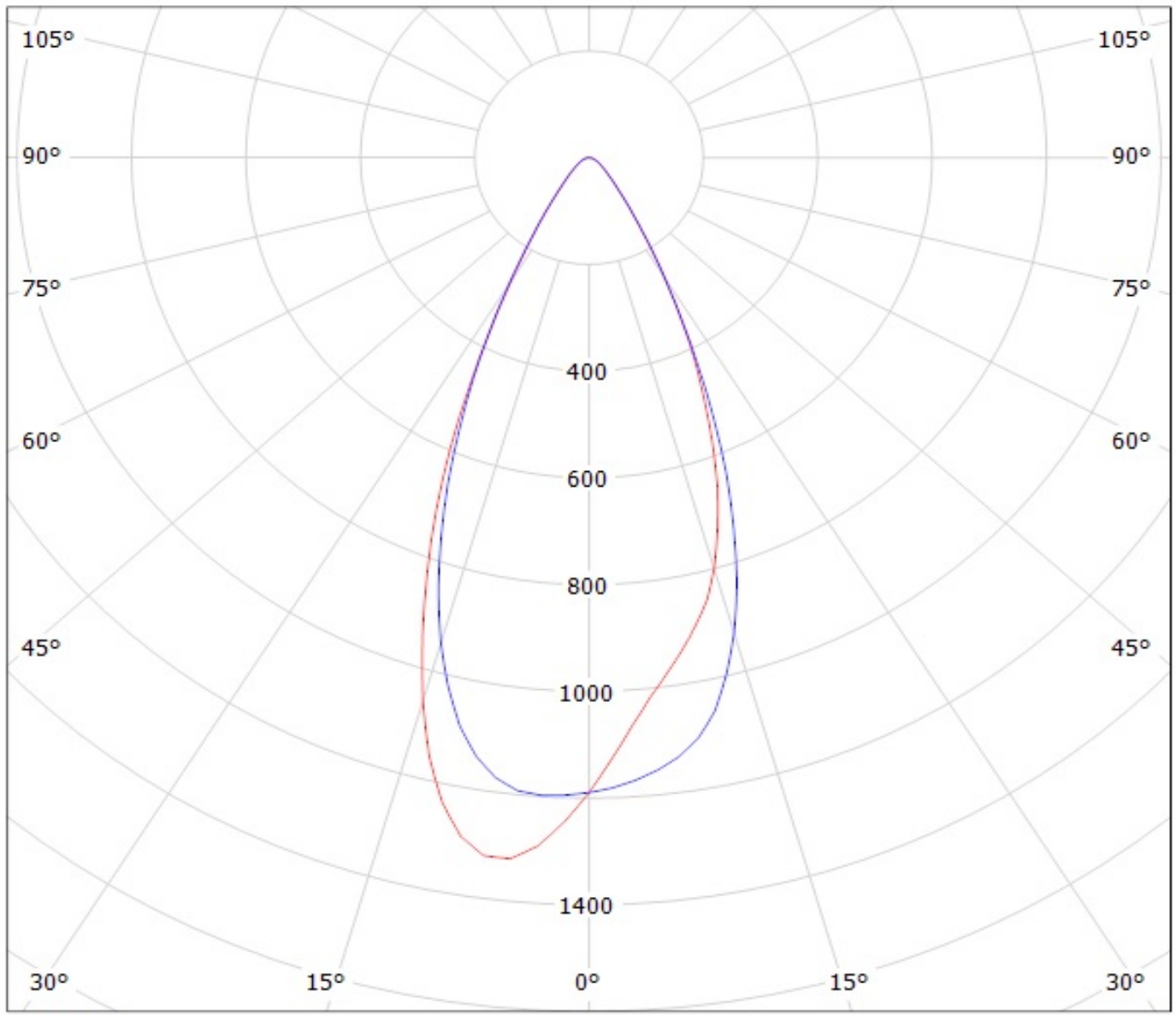

cd/klm
— C0 - C180 — C90 - C270

Luminaire: Ledil Oy CA12079_HEIDI-W2 (Nichia 219B 109lm @ 250mA) Efficiency=77%
Lamps: 1 x Nichia 219B 109lm @ 250mA

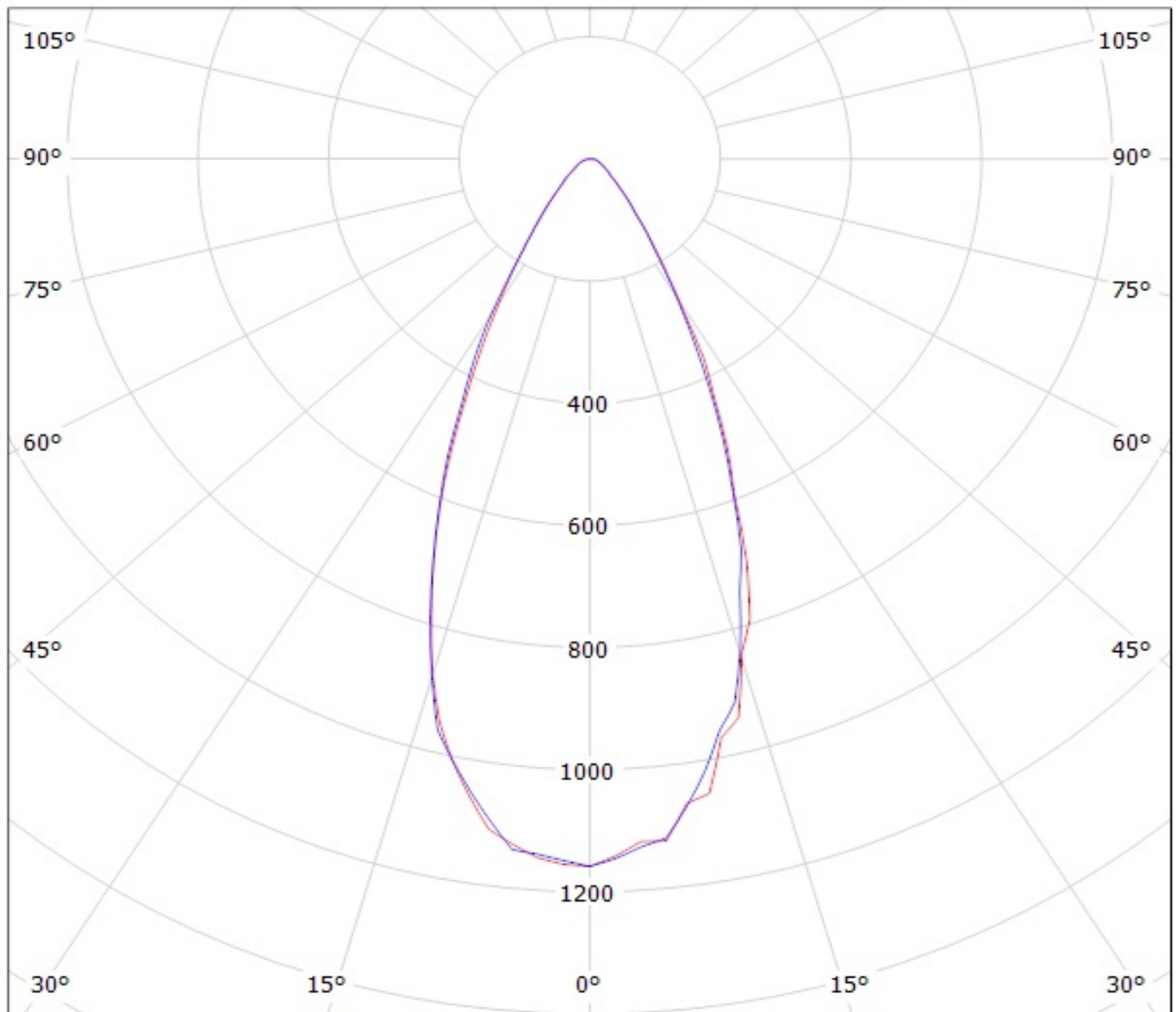

cd/klm

— C0 - C180

— C90 - C270

Luminaire: LEDiL Oy CA12079_HEIDI-W2_(Seoul_Z5M1)

Lamps: 1 x Seoul_Z5M1_107.648lm@250mA_CCT=9074K_P=0.739754W_I=249.9mA

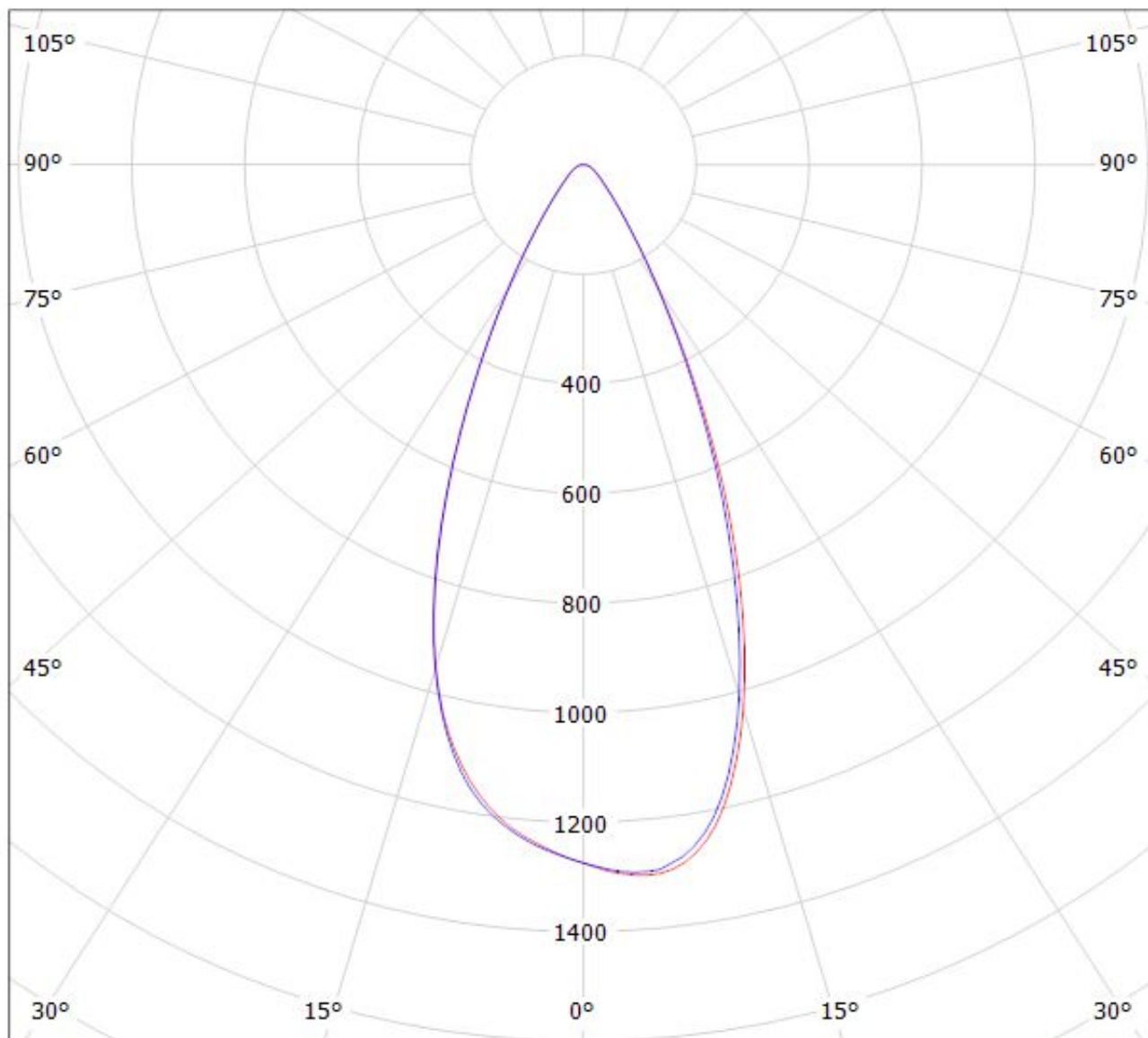

cd/klm

— C0 - C180

— C90 - C270

$\eta = 83\%$

Luminaire: LEDiL Oy CA12079_HEIDI-W2_(XP-L) Eff.79.1%
Lamps: 1 x Cree_XP-L_127.813lm@250mA_P=0.73723W_I=249.9mA

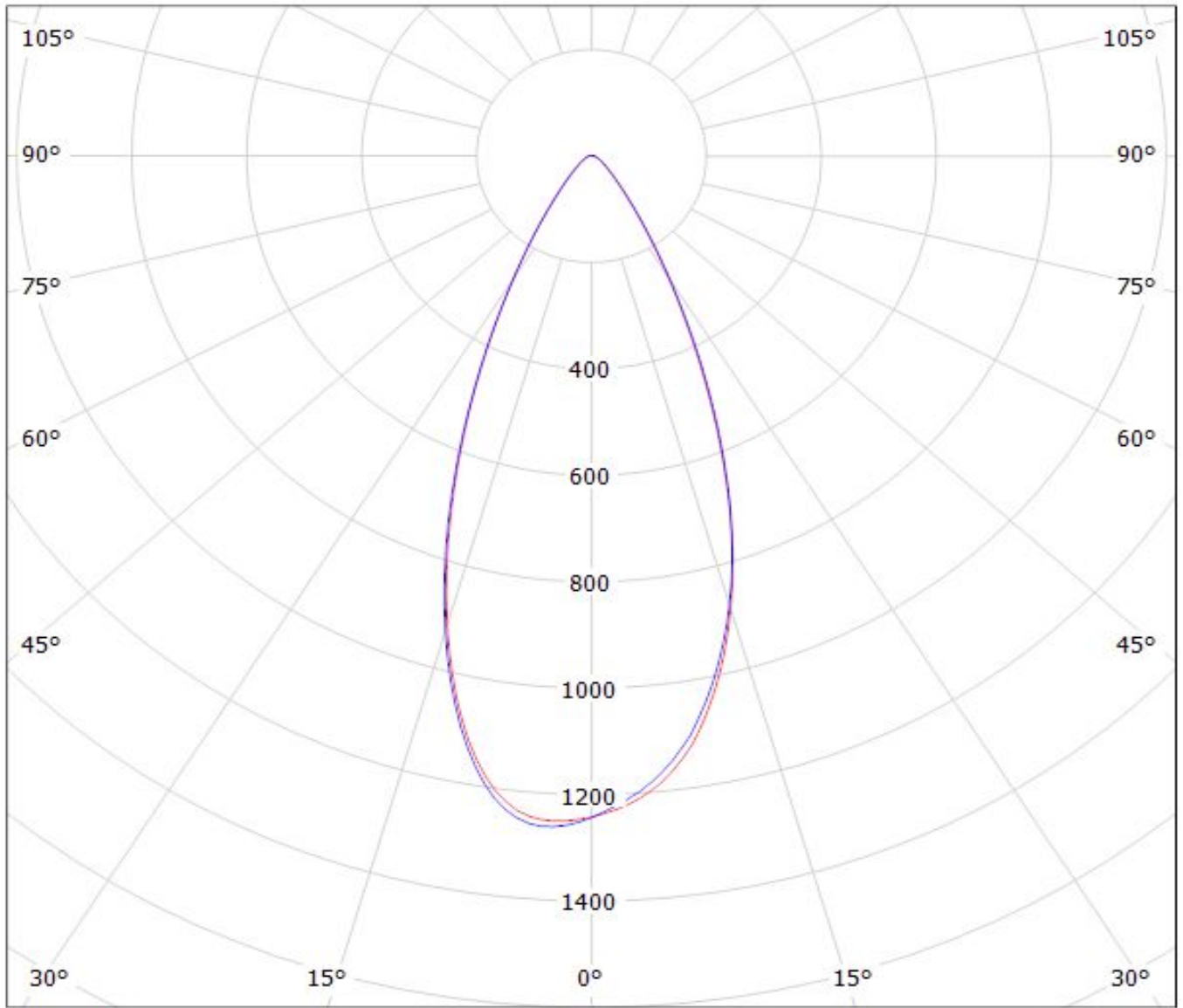

cd/klm

— C0 - C180 — C90 - C270

$\eta = 79\%$

Ledil Oy CA12079_Heidi-W2-XP LOR= 81% / LDC (Polar)

Luminaire: Ledil Oy CA12079_Heidi-W2-XP LOR= 81%

Lamps: 1 x Cree XP-E 72lm 250mA

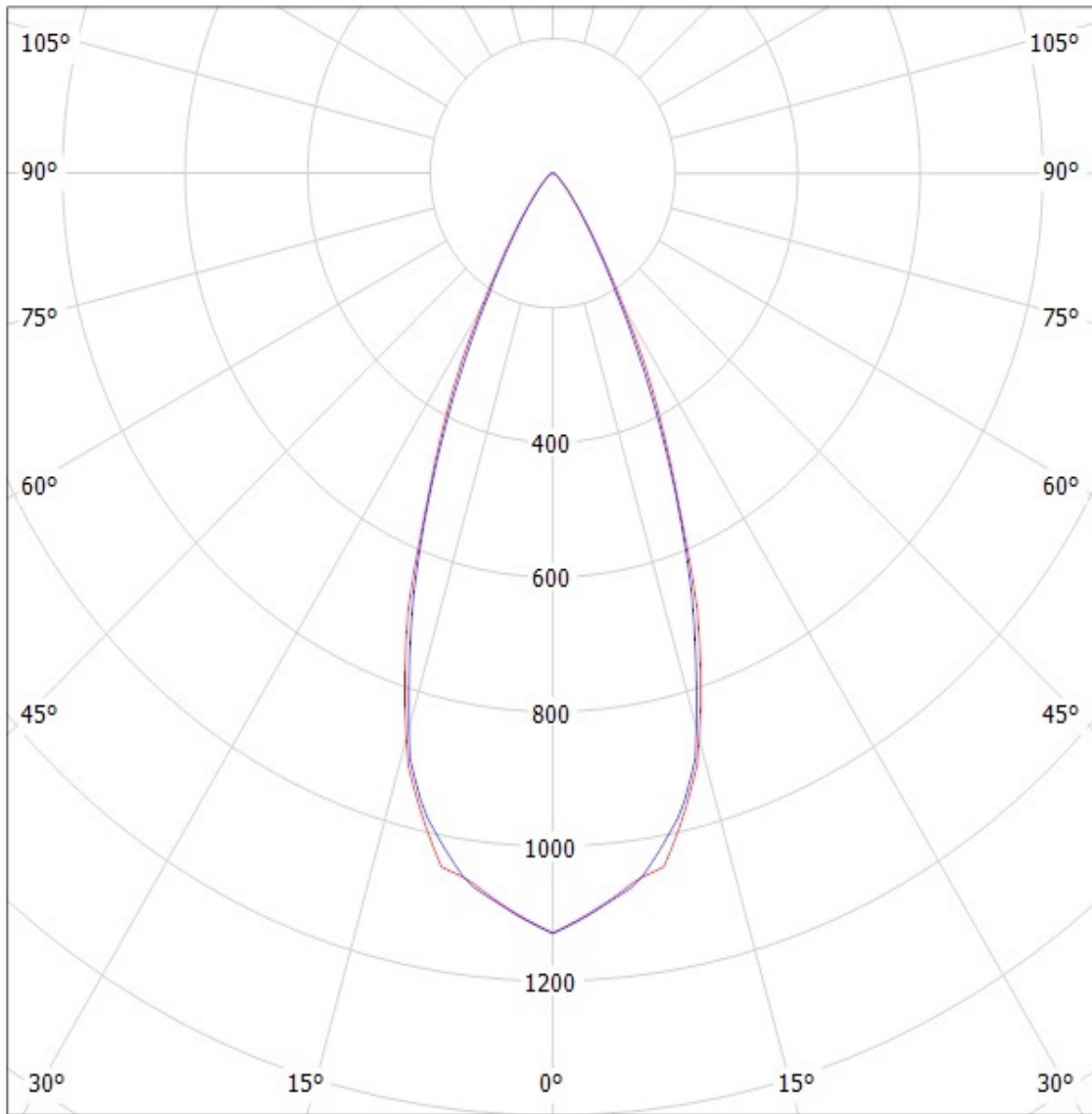

cd/klm

— C0 - C180

— C90 - C270

SIMULATED

Luminaire: LEDiL Oy CA12079_HEIDI-W2_(LUXEON_T) Eff.83%
Lamps: 1 x LUXEON T (70lm@250mA)

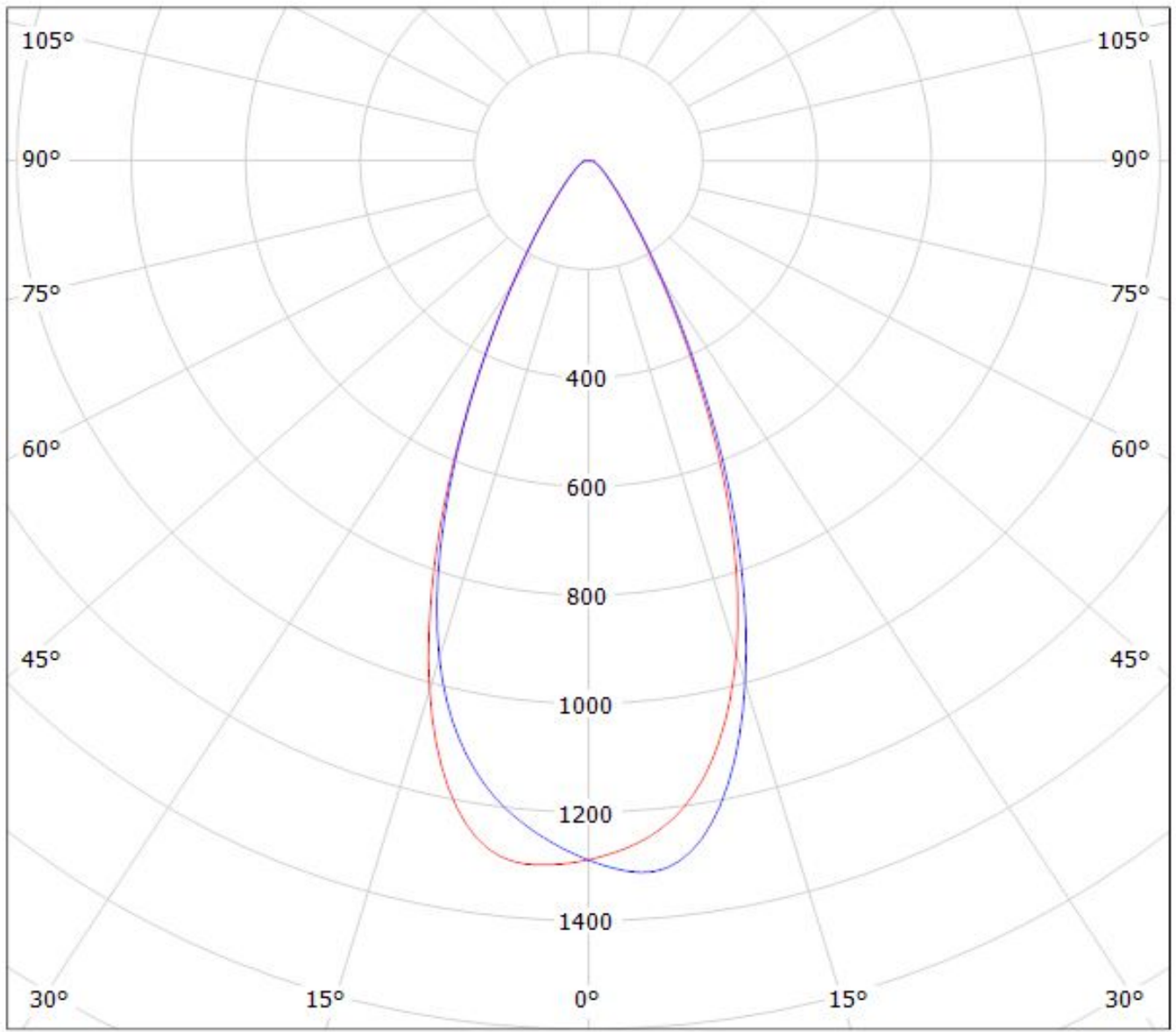

$\eta = 83\%$

cd/klm

— C0 - C180 — C90 - C270

Luminaire: Ledil Oy CA12079 HEIDI-W2_(XP-E2) Efficiency=81%
Lamps: 1 x Cree XP-E2 (92lm @ 250mA) CCT=5500K P=0.8W I=250mA

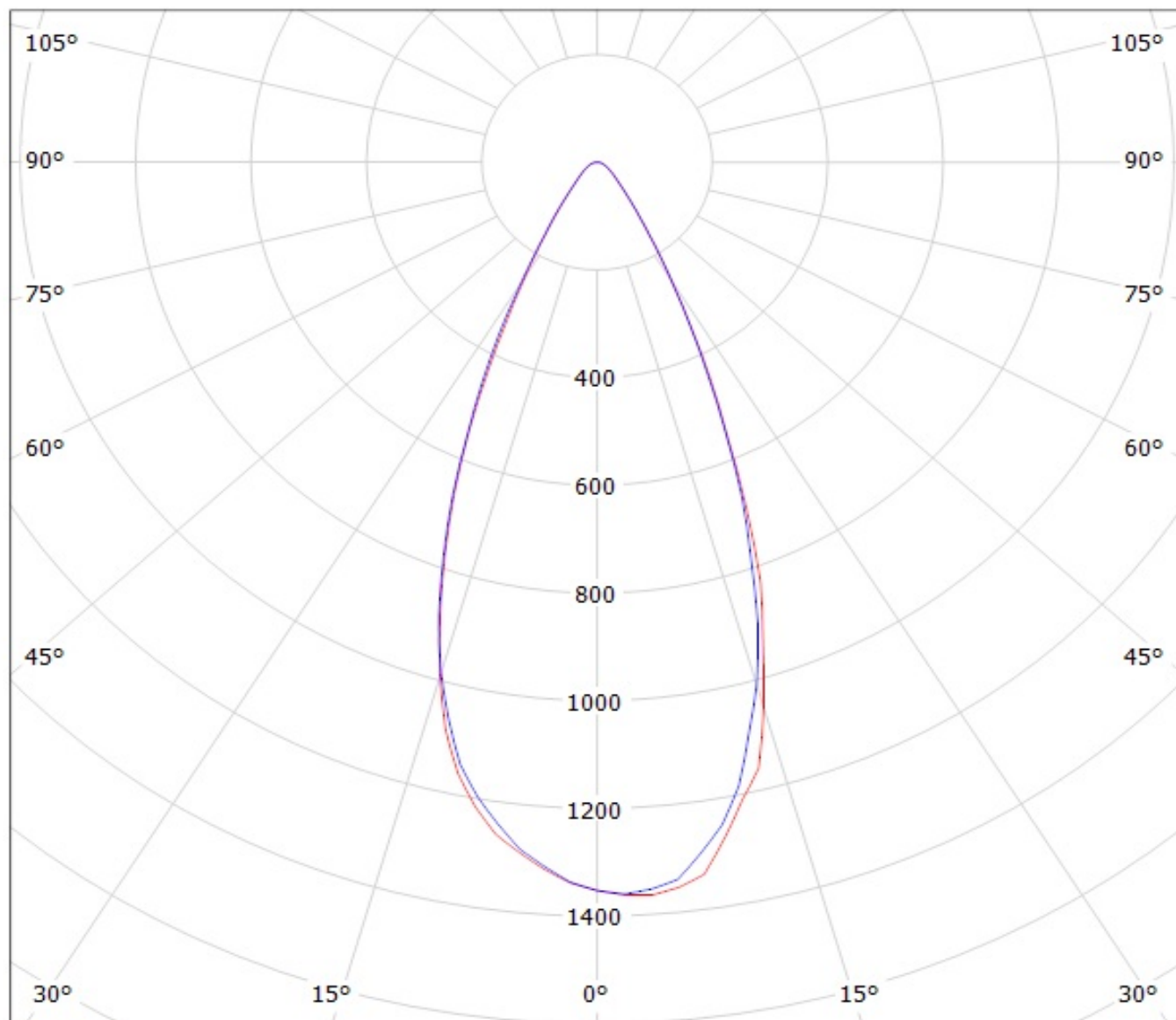

cd/klm

— C0 - C180

— C90 - C270

Luminaire: Ledil Oy CA12079_HEIDI-W2_(NCSxx19B) Efficiency=78%
Lamps: 1 x Nichia NCSxx19B (NCSL119BE) 88lm @ 250mA CCT=3000K P=0.8W I=250mA

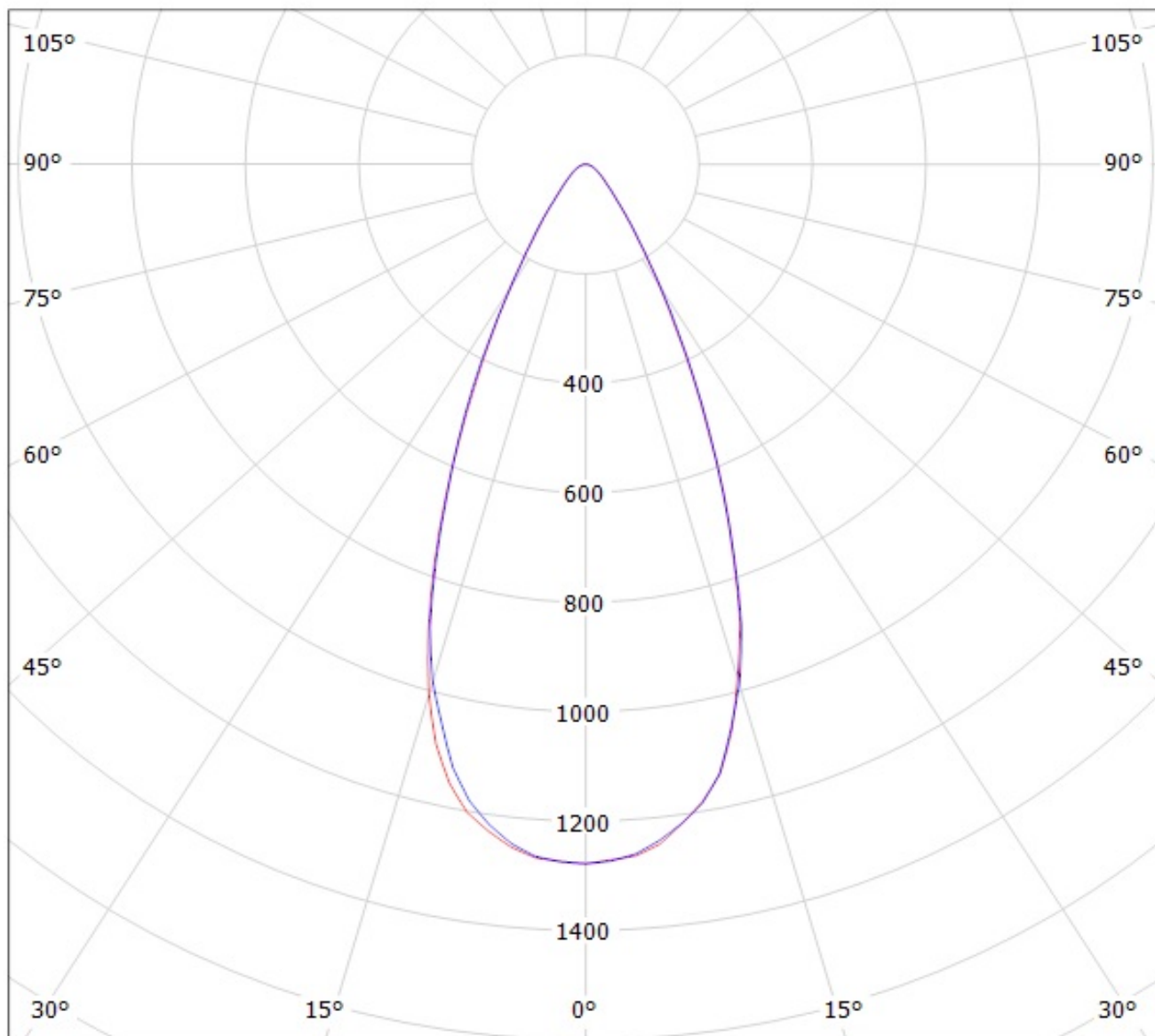

cd/klm

— C0 - C180

— C90 - C270

Luminaire: Ledil Oy CA12079_HEIDI-W2_(LH351Z) Efficiency=82%
Lamps: 1 x Samsung LH351Z (90.14lm @ 250mA) CCT=6500K P=0.7W I=250mA

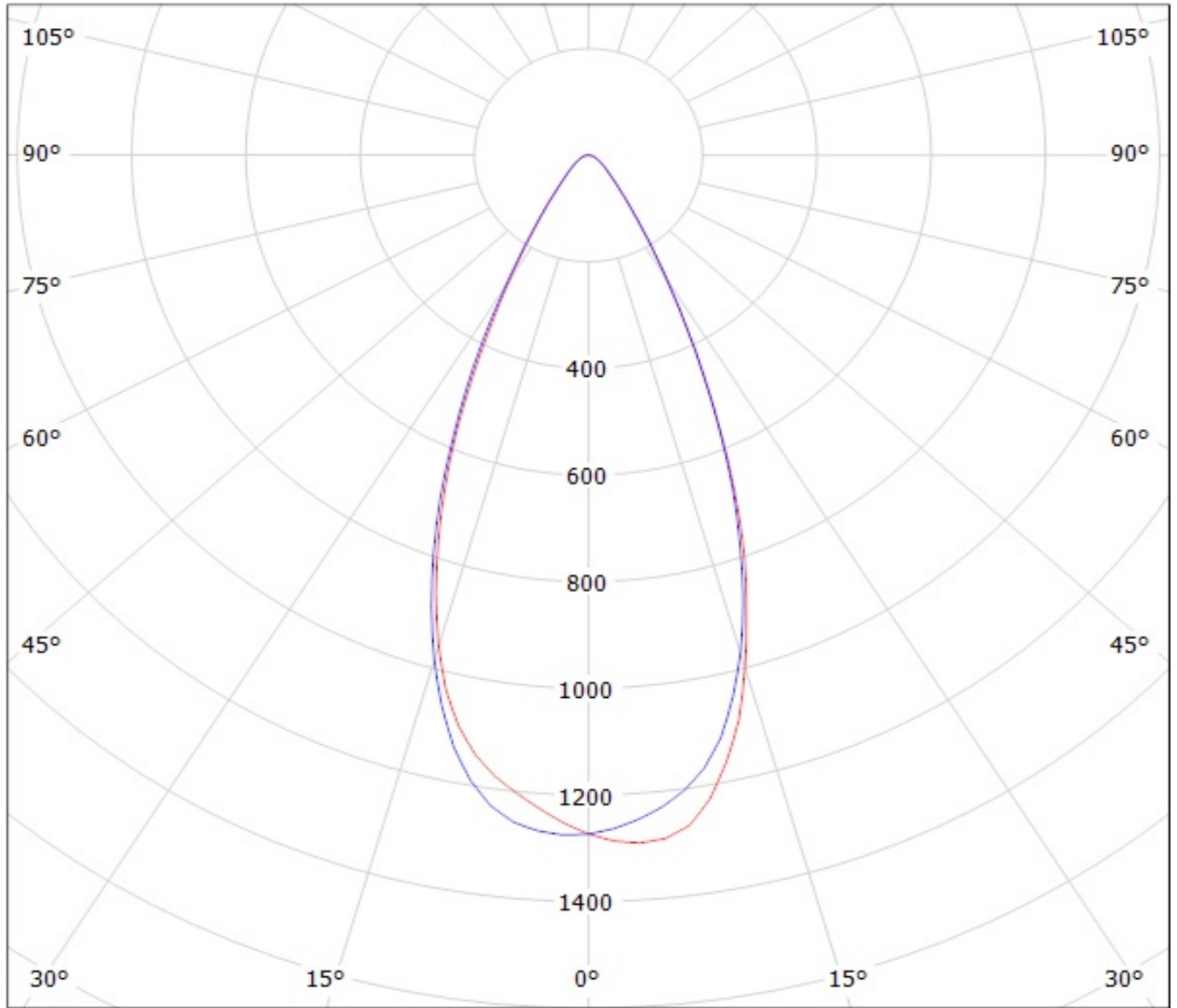

cd/klm

— C0 - C180 — C90 - C270

Luminaire: LEDil Oy CA12079_HEIDI-W2_(XP-G2) Efficiency=80%
Lamps: 1 x Cree XP-G2 (103lm @ 250mA) CCT=6600K P=0.7W I=250mA

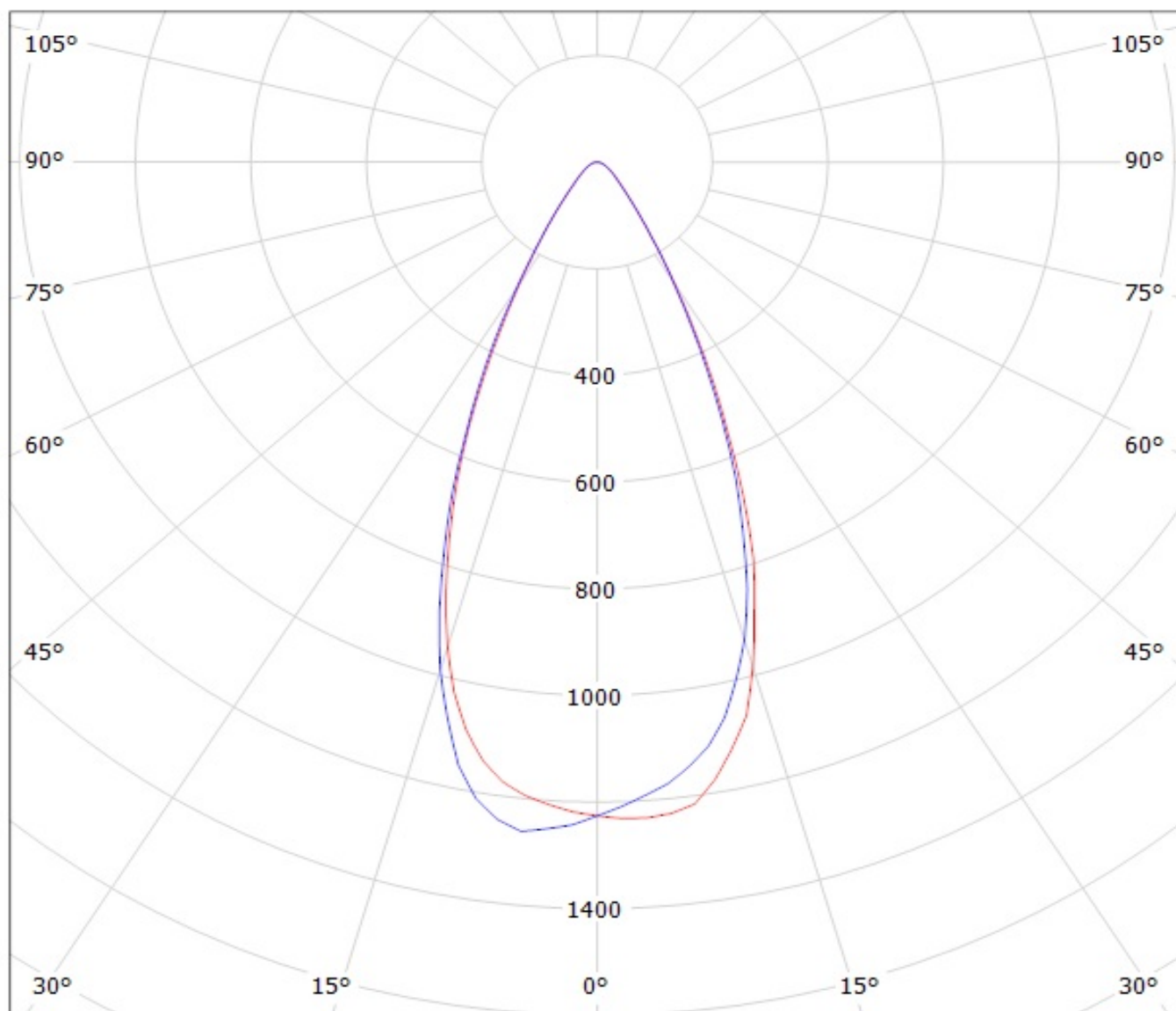

cd/klm

— C0 - C180

— C90 - C270

Ledil Oy CA12079_Heidi-W2-OSL LOR=80% / LDC (Polar)

Luminaire: Ledil Oy CA12079_Heidi-W2-OSL LOR=80%

Lamps: 1 x Osram OSL80 250mA 85lm

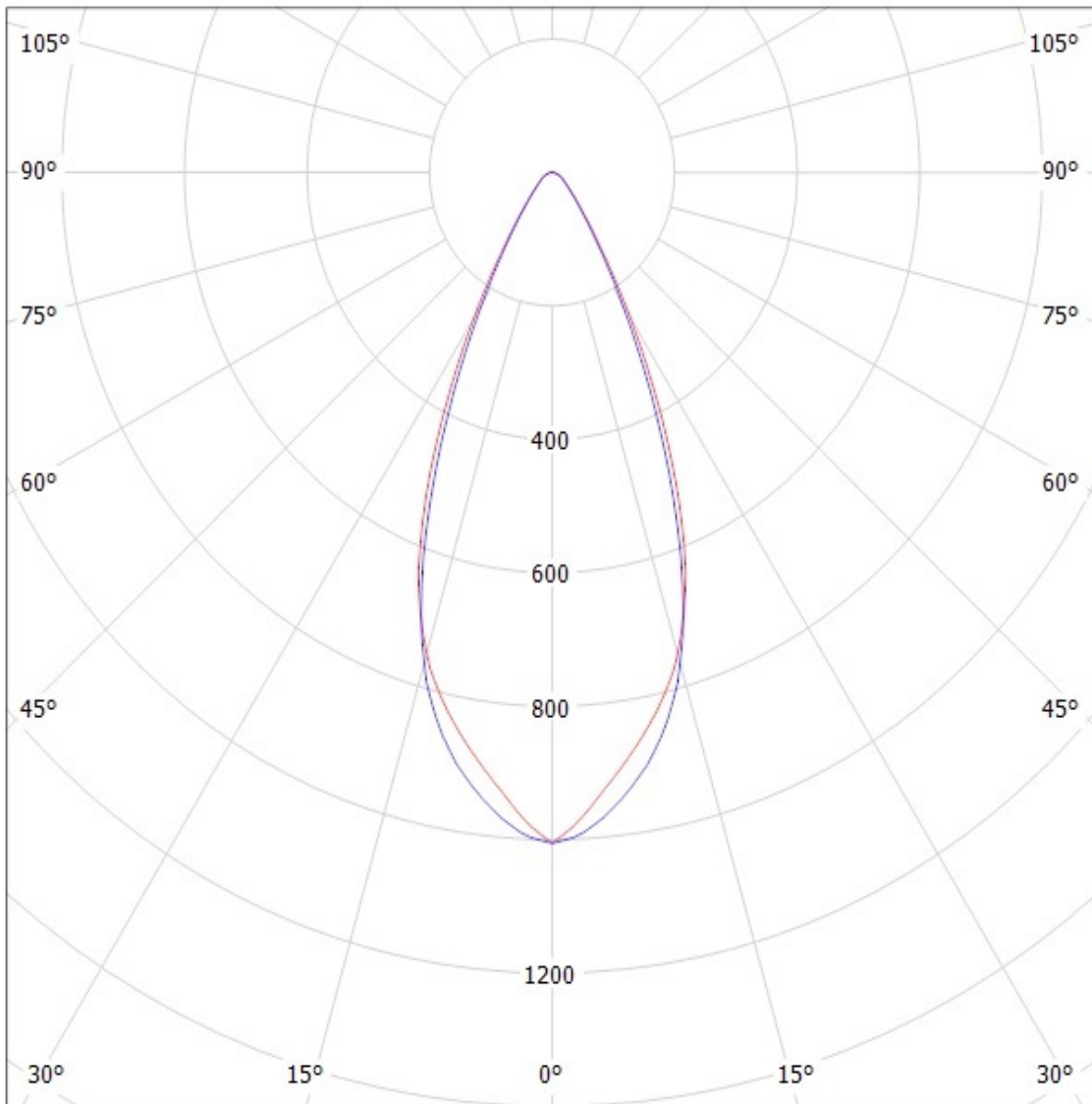

cd/klm

— C0 - C180 — C90 - C270

SIMULATED

Luminaire: Ledil Oy CA12079_Heidi-W2-RE LOR=85%

Lamps: 1 x Luxeon Rebel 250mA 84lm

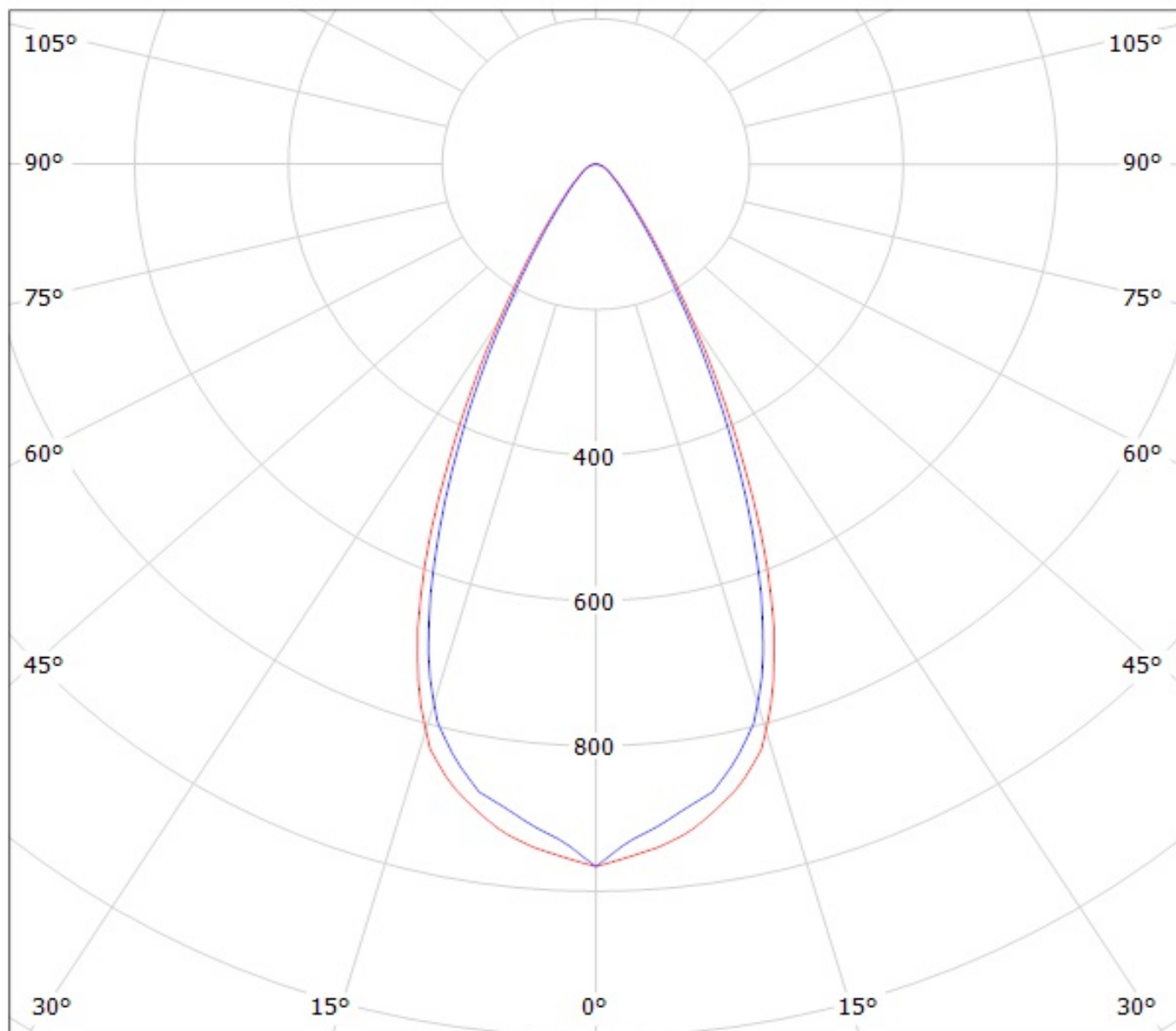

cd/klm

— C0 - C180

— C90 - C270

NOTE: The typical divergence will be changed by different color, chip size and chip position tolerance. The typical total divergence is the full angle measured where the luminous intensity is half of the peak value.