

SHARP

SYSTEM DEVICE UNIT
 ELECTRONIC COMPONENTS AND DEVICES DIVISION
 SHARP CORPORATION

SPECIFICATION

DEVICE SPECIFICATION FOR

MODEL No. PHOTOCOUPLER

PC817

Business dealing name

	PC817XNCSZ9F
	PC817X1CSZ9F
	PC817X2CSZ9F
	PC817X3CSZ9F
	PC817X4CSZ9F

Specified for _____

Enclosed please find copies of the Specifications which consists of 12 pages including cover.

This specification sheets and attached sheets shall be both side copy.

After confirmation of the contents, please be sure to send back copies of the Specifications with approving signature on each.

CUSTOMER'S APPROVAL

DATE _____

BY _____

PRESENTED

DATE Sep. 24, 2014

BY T. Ichinose

T. Ichinose,
 Department General Manager of
 Development Dept. II
 System Device Unit
 Electronic Components and Devices Division
 SHARP CORPORATION

Product name : PHOTOCOUPLER

Model No. : PC817

Business dealing name

PC817XNCSZ9F
PC817X1CSZ9F
PC817X2CSZ9F
PC817X3CSZ9F
PC817X4CSZ9F

1. These specification sheets include materials protected under copyright of Sharp Corporation ("Sharp"). Please do not reproduce or cause anyone to reproduce them without Sharp's consent.
2. When using this product, please observe the absolute maximum ratings and the instructions for use outlined in these specification sheets, as well as the precautions mentioned below. Sharp assumes no responsibility for any damage resulting from use of the product which does not comply with the absolute maximum ratings and the instructions included in these specification sheets, and the precautions mentioned below.

(Precautions)

(1) Please do verify the validity of this part after assembling it in customer's products, when customer wants to make catalogue and instruction manual based on the specification sheet of this part.

(2) This product is designed for use in the following application areas ;

- | |
|---|
| <ul style="list-style-type: none"> · OA equipment Audio visual equipment · Home appliances · Telecommunication equipment (Terminal) · Measuring equipment · Tooling machines · Computers |
|---|

If the use of the product in the above application areas is for equipment listed in paragraphs (3) or (4), please be sure to observe the precautions given in those respective paragraphs.

(3) Appropriate measures, such as fail-safe design and redundant design considering the safety design of the overall system and equipment, should be taken to ensure reliability and safety when this product is used for equipment which demands high reliability and safety in function and precision, such as ;

- | |
|---|
| <ul style="list-style-type: none"> · Transportation control and safety equipment (aircraft, train, automobile etc.) · Traffic signals · Gas leakage sensor breakers · Rescue and security equipment · Other safety equipment |
|---|

(4) Please do not use this product for equipment which require extremely high reliability and safety in function and precision, such as ;

- | |
|---|
| <ul style="list-style-type: none"> · Space equipment · Telecommunication equipment (for trunk lines) · Nuclear power control equipment · Medical equipment · Power generation and power transmission control system (Key system) |
|---|

(5) Please contact and consult with a Sharp sales representative if there are any questions regarding interpretation of the above four paragraphs.

3. Please contact and consult with a Sharp sales representative for any questions about this product.

4. Warranty term and warranty limits

【Warranty term】

The warranty term for the shipped product shall be for 1 year after shipping to the designated place by the ordered customer.

【Warranty limits】

SHARP supplies the replacement when this SHARP product shall be failed by SHARP's responsibility during above warranty term. However, this warranty is excluded in case of the following.

- (1) In case of improper handling and using by the customer.
- (2) In case of that the cause of the failure is caused by the reason other than this SHARP product.
- (3) In case of modification and repairing by person other than SHARP responsibility is not for SHARP.
- (4) In case of a calamity, a disaster and such as the case when that responsibility is not for SHARP.

This warranty herein means the warranty for this SHARP product itself, SHARP takes no responsibility for any damage caused by the failure of this SHARP product.

1. Application

This specification applies to the outline and characteristics of photocoupler Model No. PC817. (Lead free and Halogen free type).

2. Outline Refer to the attached sheet, page 4.

3. Ratings and characteristics Refer to the attached sheet, page 5, 6.

4. Reliability Refer to the attached sheet, page 7.

5. Outgoing inspection Refer to the attached sheet, page 8.

6. Supplement

6.1 Isolation voltage shall be measured in the following method.

- (1) Short between anode and cathode on the primary side and between collector and emitter on the secondary side.
- (2) The dielectric withstanding tester with zero-cross circuit shall be used.
- (3) The wave form of applied voltage shall be a sine wave.
(It is recommended that the isolation voltage be measured in insulation oil.)

6.2 Package specifications Refer to the attached sheet, page 9, 10.

6.3 Collector current (Ic) Delivery rank table ("○" mark indicates business dealing name of ordered product)

Rank at delivery	Business dealing name	Rank mark	Ic (mA)
	PC817XNCSZ9F	with or without	2.5 to 30
	PC817X1CSZ9F	A	4.0 to 8.0
	PC817X2CSZ9F	B	6.5 to 13
	PC817X3CSZ9F	C	10 to 20
	PC817X4CSZ9F	D	15 to 30

Test conditions
I _F =5mA V _{CE} =5V T _a =25°C

6.4 This Model is approved by UL.

Approved Model No. : PC817

UL file No. : E64380

6.5 This Model is approved by CQC.

Approved Model No. : PC817

6.6 This product is not designed against irradiation.

This product is assembled with electrical input and output.

This product incorporates non-coherent light emitting diode.

6.7 ODS materials

This product shall not contain the following materials.

Also, the following materials shall not be used in the production process for this product.

Materials for ODS : CFCs, Halon, Carbon tetrachloride, 1.1.1-Trichloroethane (Methyl chloroform)

6.8 Specified brominated flame retardants

Specified brominated flame retardants (PBB and PBDE) are not used in this device at all.

6.9 Compliance with each regulation

(1) The RoHS directive (2002/95/EC)

This product complies with the RoHS directive (2002/95/EC) .

Object substances: mercury, lead, cadmium, hexavalent chromium, polybrominated biphenyls (PBB) and polybrominated diphenyl ethers (PBDE)

(2) Content of six substances specified in Management Methods for Control of Pollution Caused by Electronic Information

Products Regulation (Chinese : 电子信息产品污染控制管理办法).

Category	Toxic and hazardous substances					
	Lead (Pb)	Mercury (Hg)	Cadmium (Cd)	Hexavalent chromium (Cr ⁶⁺)	Polybrominated biphenyls (PBB)	Polybrominated diphenyl ethers (PBDE)
Photocoupler	✓	✓	✓	✓	✓	✓

✓: indicates that the content of the toxic and hazardous substance in all the homogeneous materials of the part is below the concentration limit requirement as described in SJ/T 11363-2006 standard .

(3) This product complies with “Halogen free”.

“Halogen free” about this product is defined as follows.

The concentration ratio of Chlorinate and Bromine in raw material and indirect material , finished product can not exceed 900 ppm, the total concentration of the 2 substance should not exceed 1500 ppm.

7. Notes

Precautions for photocouplers : Attachment-1

2. Outline

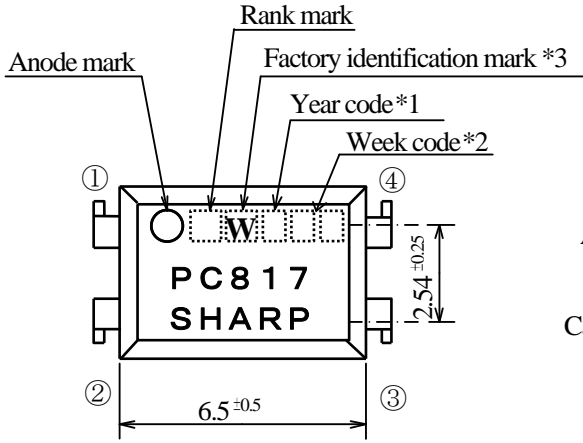

Pin-Number and internal connection diagram

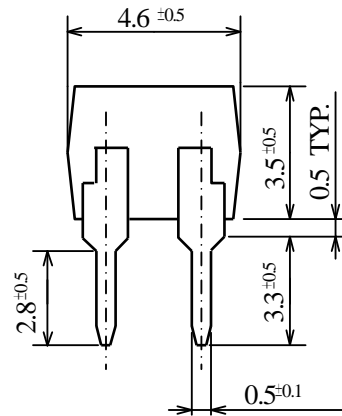
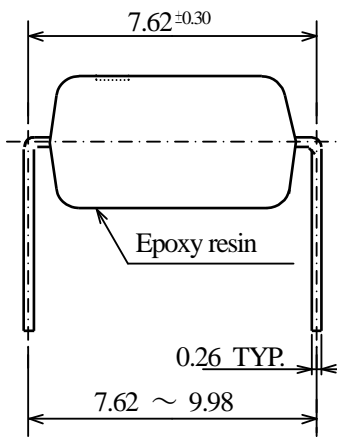
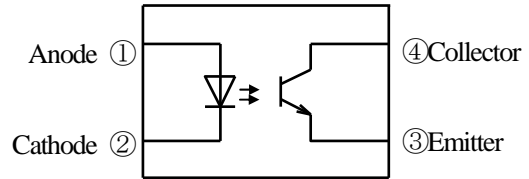

- *1) Year date code
- *2) 2-digit work week
- *3) Factory identification marks applies to the below
W : Lite-ON OPTO Technology (Changzhou) Co., Ltd. (CHINA)

Pin material : Cu Alloy
Pin finish : Pure Tin plating

Product mass : Approx. 0.23 g

Marking is laser marking

UNIT : 1/1 mm	
Name	PC817 Outline Dimensions (Business dealing name : PC817X*CSZ9F)

3. Ratings and characteristics

3.1 Absolute maximum ratings

Ta=25°C

Parameter		Symbol	Rating	Unit
Input	*1 Forward current	I _F	50	mA
	Peak forward current	I _{FM}	1	A
	Reverse voltage	V _R	6	V
	Power dissipation	P	70	mW
Output	Collector-emitter voltage	V _{CEO}	80	V
	Emitter-collector voltage	V _{ECO}	6	V
	Collector current	I _c	50	mA
	*1 Collector power dissipation	P _c	150	mW
Total power dissipation		P _{tot}	200	mW
Operating temperature		T _{opr}	-30 to +100	°C
Storage temperature		T _{stg}	-55 to +125	°C
*2 Isolation voltage		V _{iso(tms)}	5	kV
*3 Soldering temperature		T _{sol}	270	°C

*1 The derating factors of absolute maximum ratings due to ambient temperature are shown in Fig. 1 to 2.

*2 AC For 1 min, 40 to 60%RH

Isolation voltage shall be measured using the following method.

(1) Short between anode and cathode on the primary side and between collector and emitter on the secondary side.

(2) The isolation voltage tester with zero-cross circuit shall be used.

(3) The waveform of applied voltage shall be a sine wave.

*3 For 10s

3.2 Electro-optical characteristics

Ta=25°C

Parameter		Symbol	Condition	MIN.	TYP.	MAX.	Unit
Input	Forward voltage	V _F	I _F =20mA	-	1.2	1.4	V
	Peak forward voltage	V _{FM}	I _{FM} =0.5A	-	-	3.0	V
	Reverse current	I _R	V _R =4V	-	-	10	μA
	Terminal capacitance	C _t	V=0, f=1kHz	-	30	250	pF
Output	Dark current	I _{CEO}	V _{CE} =50V, I _F =0	-	-	100	nA
	Collector-emitter breakdown voltage	BV _{CEO}	I _c =0.1mA, I _F =0	80	-	-	V
	Emitter-collector breakdown voltage	BV _{ECO}	I _E =10 μA, I _F =0	6	-	-	V
Transfer characteristics	Collector current	I _c	I _F =5mA, V _{CE} =5V	2.5	-	30	mA
	*4 Current Transfer Ratio	CTR		50	-	600	%
	Collector-emitter saturation voltage	V _{CE(sat)}	I _F =20mA, I _c =1mA	-	0.1	0.2	V
	Isolation resistance	R _{ISO}	DC500V, 40 to 60%RH	5 × 10 ¹⁰	10 ¹¹	-	Ω
	Floating capacitance	C _f	V=0, f=1MHz	-	0.6	1.0	pF
	Cut-off frequency	f _c	V _{CE} =5V, I _c =2mA R _L =100Ω, -3dB	-	80	-	kHz
	Rise time	t _r	V _{CE} =2V, I _c =2mA	-	4	18	μs
	Fall time	t _f	R _L =100Ω	-	3	18	μs

*4 CTR (%) = (I_c / I_F) × 100

(Fig. 1) Forward current vs. ambient temperature

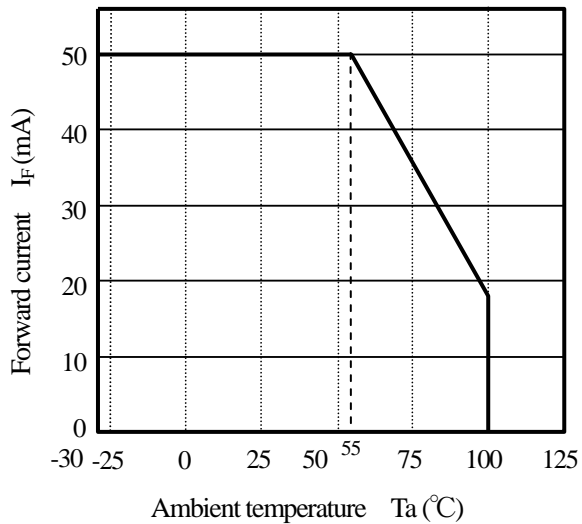

(Fig. 2) Collector power dissipation vs. ambient temperature

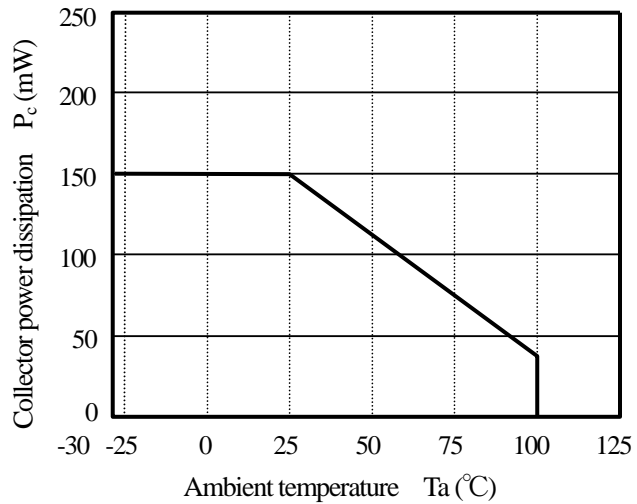

4. Reliability

The reliability of products shall satisfy items listed below.

Test item as require

Test title	Test condition
Pre-condition test	125°C=24h, 85°C 85%RH=168h, and IR reflow 260°C peak=3 cycles
Temperature cycling test	Ta=-55~125°C, Dwell time=15min per zone, 1000 cycles
Room temperature operation life test	Ta=25°C, I _F =50mA, 1000h
High temperature operation life test	Ta=110°C, I _F =20mA, I _C =30mA, 1000h
High temperature & high humidity bias test	Ta=85°C, 85%RH, V _{CE} =64V, 1000h
High temperature bias test	Ta=110°C, V _{CE} =80V, 1000h
High temperature storage test	Ta=150°C, 1000h
Low temperature storage test	Ta=-55°C, 1000h
Autoclave	Temperature=121°C, 100%RH and 15Psi, 168h

Spec limit of product

Parameter	Symbol	Measurement condition	Ta=25°C		Unit
			MIN.	MAX.	
Forward voltage	V _F	I _F =20mA	-	1.4	V
Reverse current	I _R	V _R =4V	-	10	μA
Dark current	I _{CEO}	V _{CE} =50V	-	100	nA
Collector-emitter breakdown voltage	BV _{CEO}	I _C =0.1mA	80	-	V
Emitter-collector breakdown voltage	BV _{ECO}	I _E =10 μA	6	-	V
Collector-emitter saturation voltage	V _{CE(sat)}	I _F =20mA, I _C =1mA	-	0.2	V
Current Transfer Ratio	CTR	I _F =5mA, V _{CE} =5V	50	600	%

Reliability criteria

1. Reading value for each step test not over 50% Delta for V_F, BV_{CEO}, BV_{ECO} and I_C parameter.
2. Reading value for each step test not over spec limit for I_R, I_{CEO} and V_{CE(sat)} parameter.
3. Short and open is criteria of Temperature cycling test and Autoclave test item.

5. Outgoing inspection

5.1 Inspection items

(1) Appearance

5.2 Sampling method and Inspection level

A single sampling plan, normal inspection level II based on ISO 2859 is applied.

The AQL according to the inspection items are shown below.

Defect	Inspection item	AQL (%)
Major defect	Unreadable marking	0.15
Minor defect	Appearance defect except the above mentioned.	0.65

6.2 Packing specification

6.2.1 Package materials

Name	Materials
Sleeve	PS
Stopper	TPR(Thermoplastic rubber)
Packing case (Inner box)	Paper
Packing case (Outer carton)	

6.2.2 Packing data

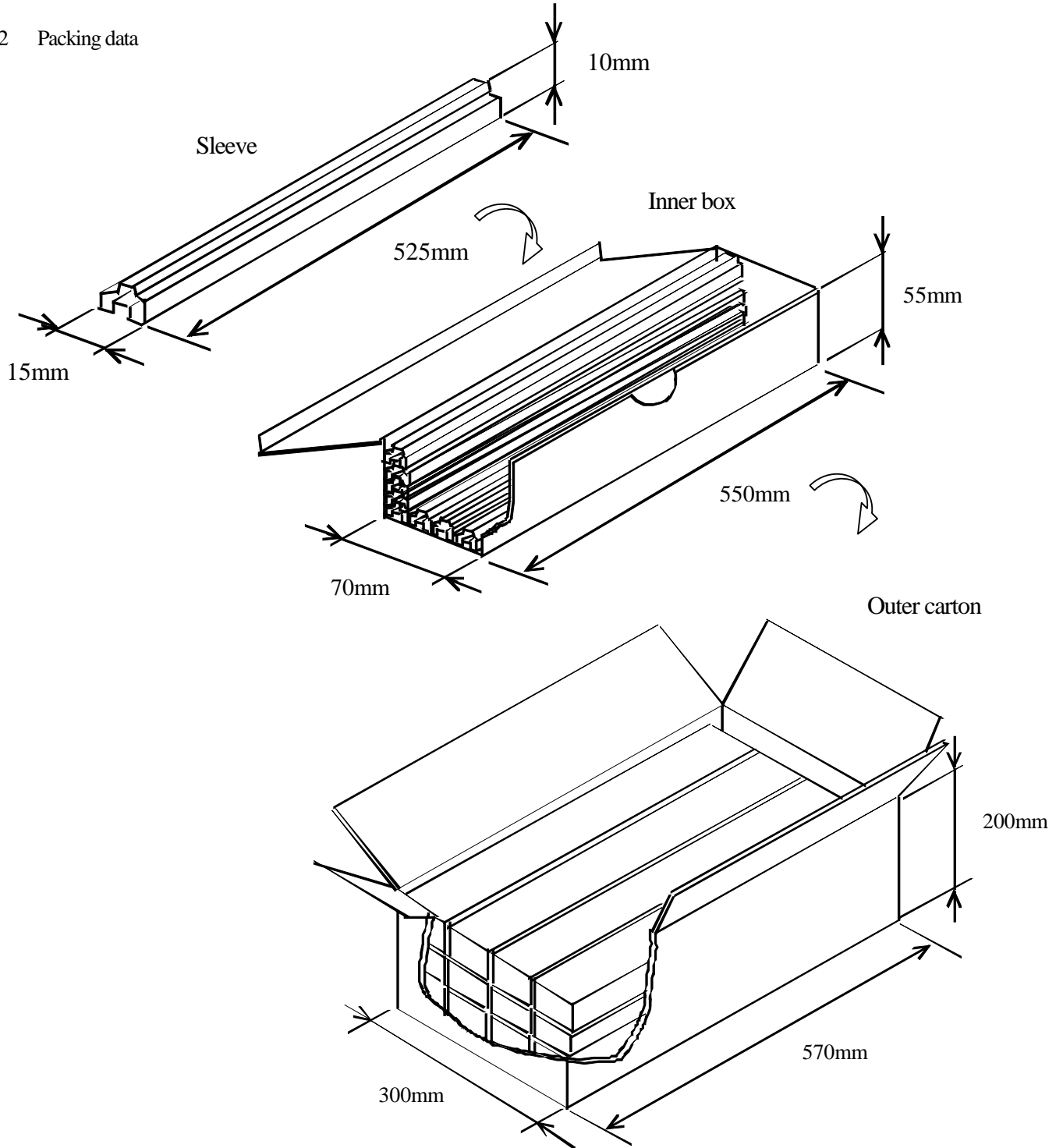

Sleeve volume (pcs/sleeve)	Inner box volume (sleeve/box)	Outer carton volume (box/carton)	Total volume (pcs/outer carton)
100	20	12	24000

6.2.3 Sleeve and Stopper data

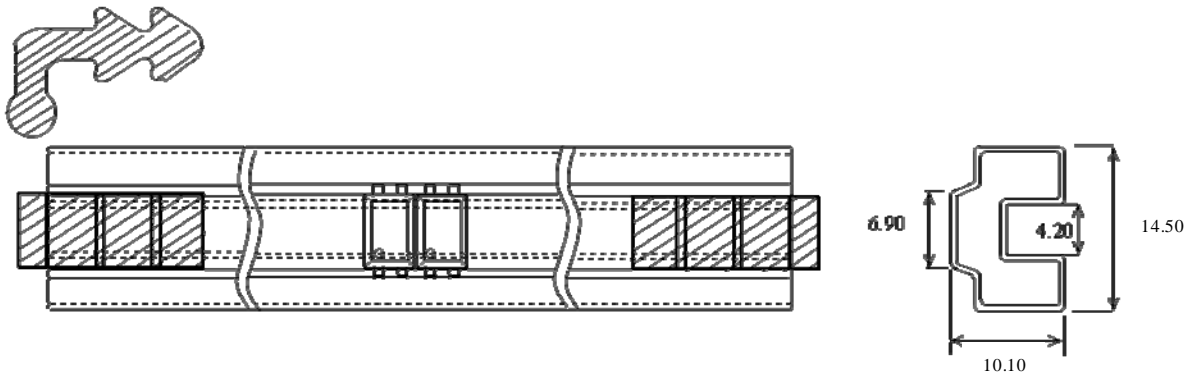

All dimensions are in millimeters.

Precautions for Photocouplers

1. Cleaning

- (1) Solvent cleaning : Solvent temperature 45°C or less
Immersion for 3 min or less
- (2) Ultrasonic cleaning : The effect to device by ultrasonic cleaning differs by cleaning bath size, ultrasonic power output, cleaning time, PCB size or device mounting condition etc. Please test it in actual using condition and confirm that any defect doesn't occur before starting the ultrasonic cleaning.
- (3) Applicable solvent : Ethyl alcohol, Methyl alcohol, Isopropyl alcohol
When the other solvent is used, there are cases that the packaging resin is eroded.
Please use the other solvent after thorough confirmation is performed in actual using condition.

2. Circuit design

- 2.1 The LED used in the Photocoupler generally decreases the light emission power by operation.
In case of long operation time, please design the circuit in consideration of the degradation of the light emission power of the LED. (50%/5years)
- 2.2 There are cases that the deviation of the CTR and the degradation of the relative light emission power of the LED increase when the setting value of I_F is less than 1.0mA. Please design the circuit in consideration of this point.

3. Precautions for Soldering

- (1) In the case of flow soldering (Avoid immersing units body in the solder)
One time soldering is recommended within the condition of temperature.
Temperature: 260+0/-5°C
Time: 10 s.
Preheat temperature: 25 to 140°C
Preheat time: 30 to 80 s

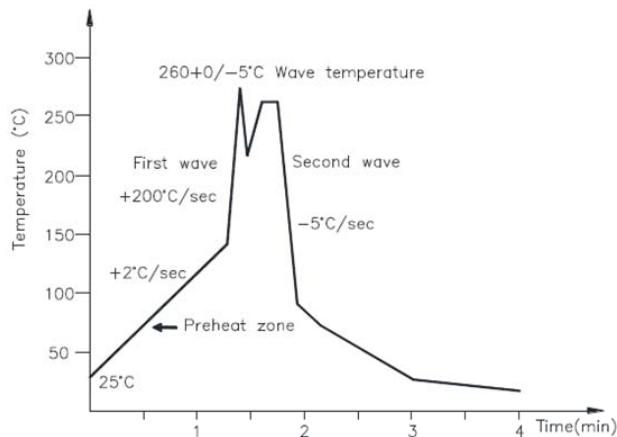

- (2) In the case of hand soldering by soldering iron
Allow single lead soldering in every single process. One time soldering is recommended.
Temperature: 380+0/-5°C
Time: (max.) 3s
- (3) Other precautions
Depending on equipment and soldering conditions (temperature, Using solder etc.), the effect to the device and the PCB is different.
Please confirm that there is no problem on the actual use conditions in advance.