

SFH 2713

CHIPLED®

IR-Cut Silicon PIN Photodiode

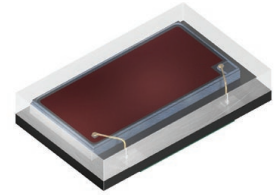

Applications

- Health Monitoring (Heart Rate Monitoring, Pulse Oximetry)

Features:

- Package: clear epoxy
- ESD: 1.5 kV acc. to ANSI/ESDA/JEDEC JS-001 (HBM)
- Suitable for reflow soldering
- Small outline dimensions

Ordering Information

Type	Photocurrent typ. $E_e = 0.1 \text{ mW/cm}^2; \lambda = 530 \text{ nm}; V_R = 5 \text{ V}$ I_P	Ordering Code
SFH 2713	0.95 μA	Q65112A8151

Maximum Ratings

Parameter	Symbol		Values
Operating Temperature	T_{op}	min.	-40 °C
		max.	85 °C
Storage temperature	T_{stg}	min.	-40 °C
		max.	85 °C
Reverse voltage	V_R	max.	16 V
ESD withstand voltage acc. to ANSI/ESDA/JEDEC JS-001 (HBM)	V_{ESD}	max.	1.5 kV

Characteristics

$T_A = 25\text{ °C}$

Parameter	Symbol		Values
Wavelength of max sensitivity	$\lambda_{S\text{ max}}$	typ.	635 nm
Spectral range of sensitivity	$\lambda_{10\%}$	typ.	400 ... 660 nm
Radiant sensitive area	A	typ.	3.27 mm ²
Dimensions of chip area	L x W	typ.	2.8 x 1.4 mm x mm
Half angle	φ	typ.	63 °
Dark current	I_R	typ.	0.1 nA
$V_R = 5\text{ V}$		max.	5 nA
Rise time	t_r	typ.	22 ns
$V_R = 5\text{ V}; R_L = 50\ \Omega; \lambda = 530\text{ nm}$			
Fall time	t_f	typ.	31 ns
$V_R = 5\text{ V}; R_L = 50\ \Omega; \lambda = 530\text{ nm}$			
Forward voltage	V_F	typ.	0.90 V
$I_F = 10\text{ mA}; E = 0$			
Capacitance	C	typ.	50 pF
$V_R = 5\text{ V}; f = 1\text{ MHz}; E = 0$			

Relative Spectral Sensitivity ^{1), 2)}

$$S_{rel} = f(\lambda)$$

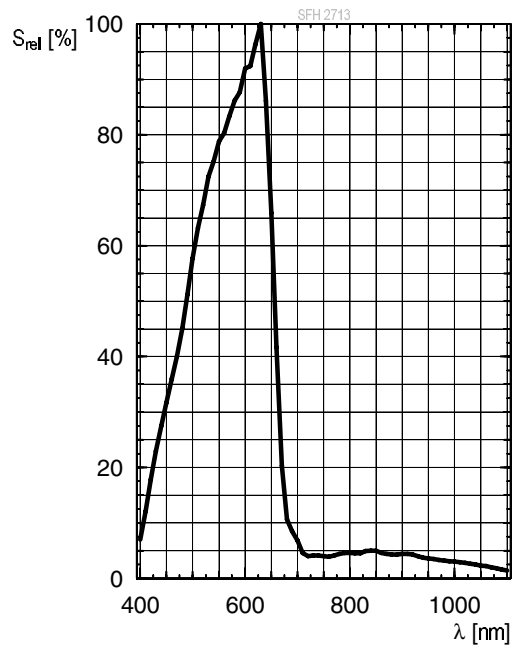

Directional Characteristics ^{1), 2)}

$$S_{rel} = f(\varphi)$$

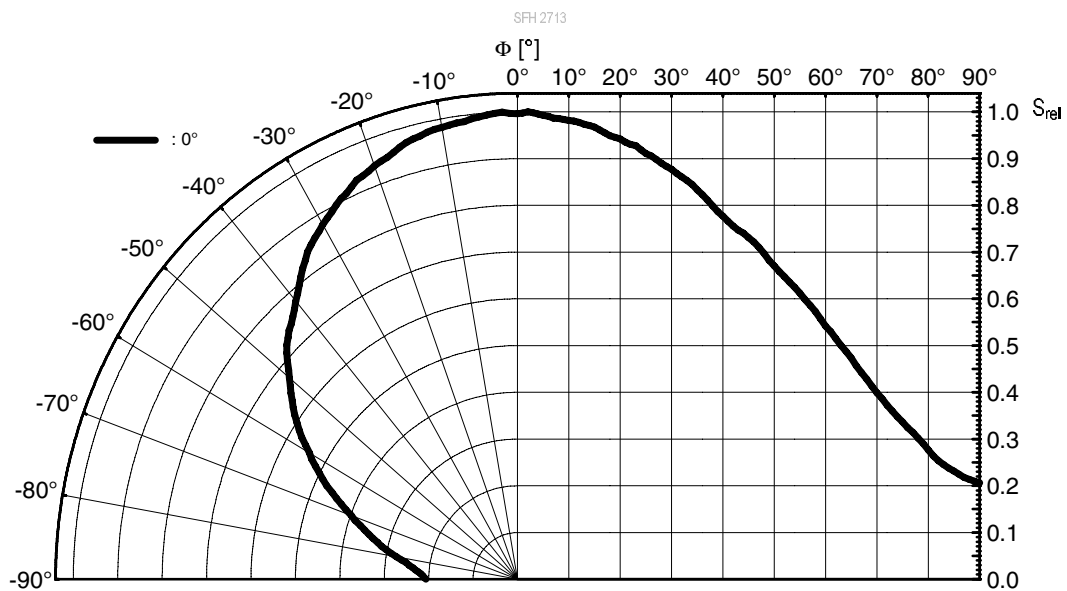

Photocurrent 1), 2)

$I_p = f(E_e); \lambda = 530 \text{ nm}; V_R = 5 \text{ V}$

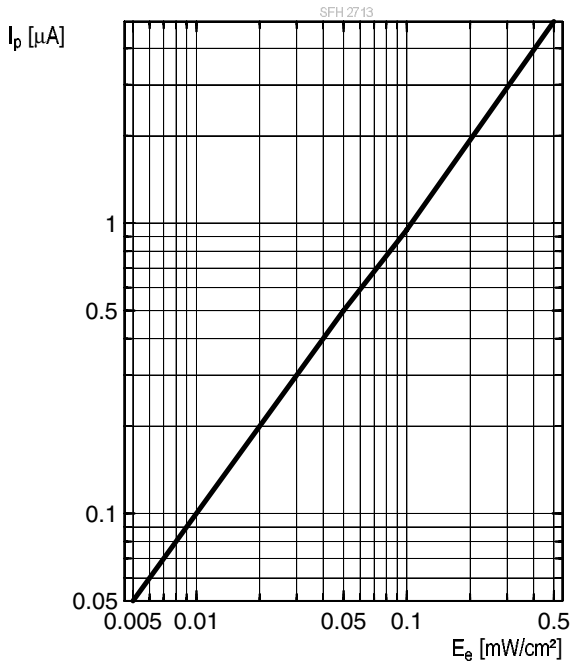

Dark Current 1), 2)

$I_R = f(V_R); E = 0$

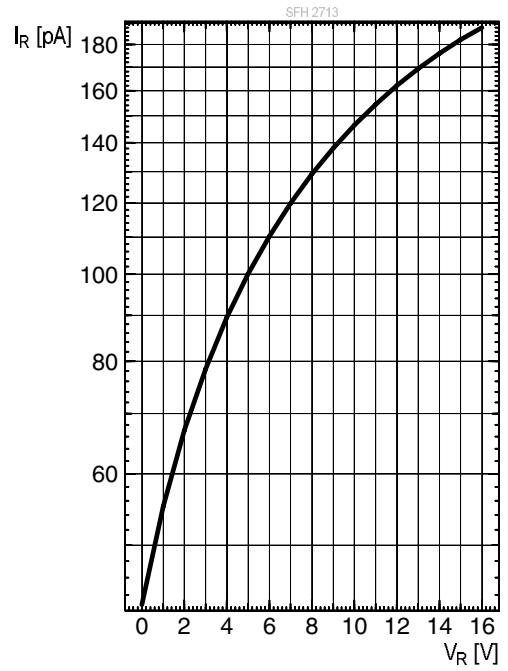

Capacitance 1), 2)

$C = f(V_R); f = 1\text{MHz}; E = 0; T_A = 25^\circ\text{C}$

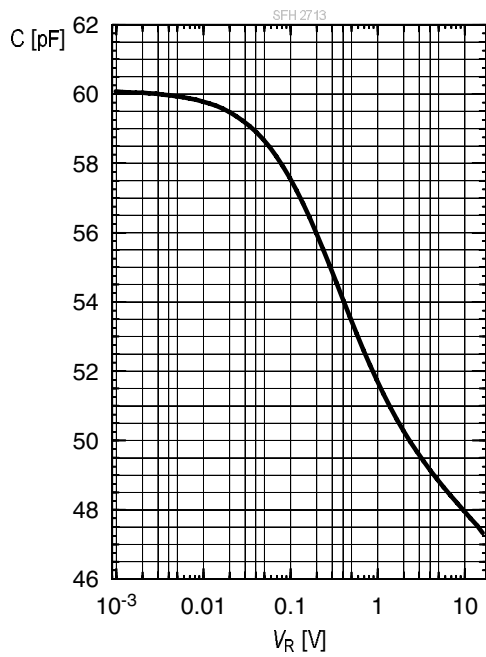

Dimensional Drawing ³⁾

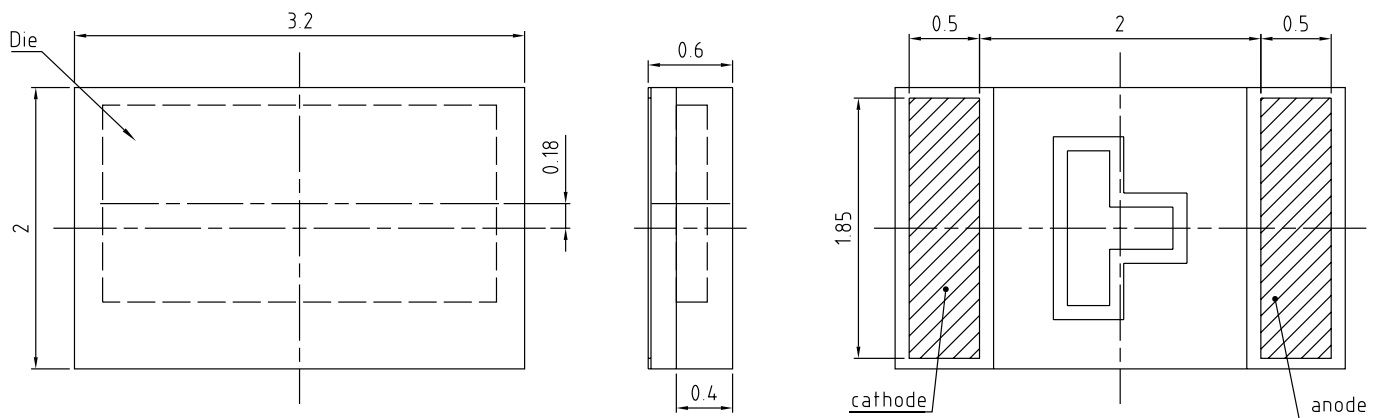

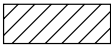
lead finish Au
 general tolerance ± 0.1 

C67062-A0308-A3..-02

Further Information:

Approximate Weight: 7.0 mg

Package marking: Anode

Recommended Solder Pad ³⁾

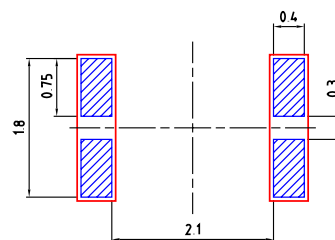
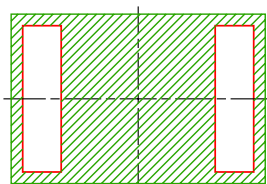
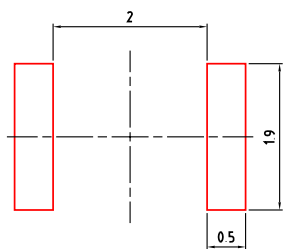

 foot print

 solder resist

 solder stencil
recommended stencil
thickness 120µm

Component Location on Pad

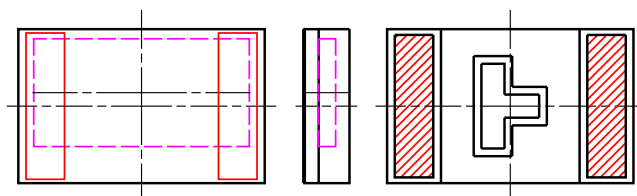

E062.3010.282 -01

Reflow Soldering Profile

Product complies to MSL Level 3 acc. to JEDEC J-STD-020E

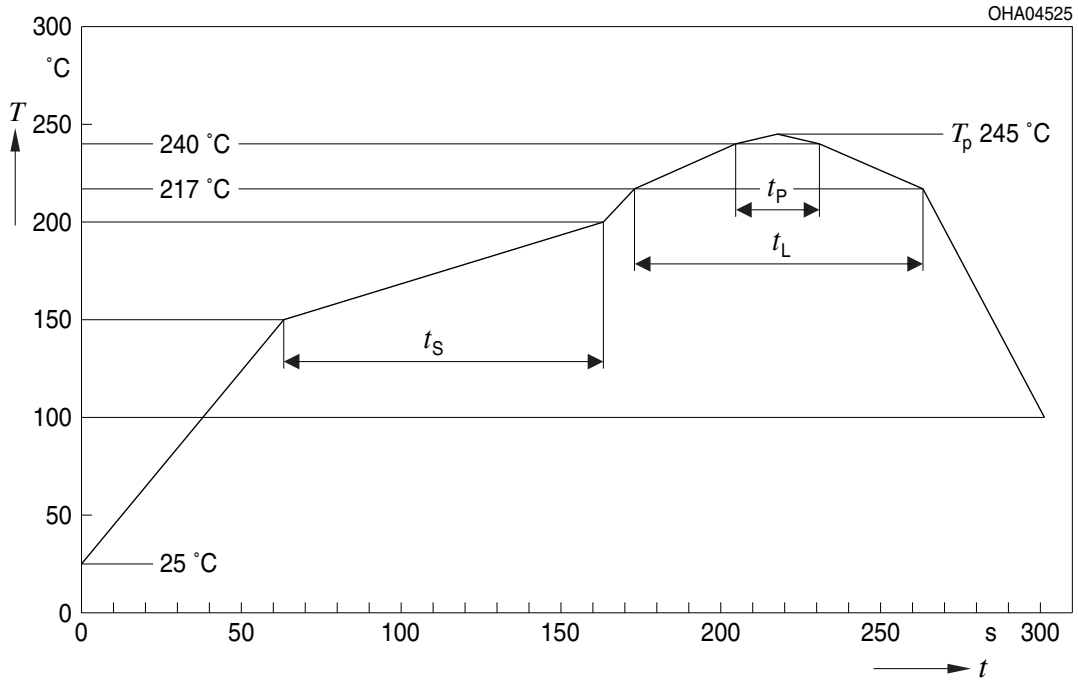

Profile Feature	Symbol	Pb-Free (SnAgCu) Assembly			Unit
		Minimum	Recommendation	Maximum	
Ramp-up rate to preheat ^{*)} 25 °C to 150 °C			2	3	K/s
Time t_s T_{Smin} to T_{Smax}	t_s	60	100	120	s
Ramp-up rate to peak ^{*)} T_{Smax} to T_p			2	3	K/s
Liquidus temperature	T_L		217		°C
Time above liquidus temperature	t_L		80	100	s
Peak temperature	T_p		245	260	°C
Time within 5 °C of the specified peak temperature $T_p - 5$ K	t_p	10	20	30	s
Ramp-down rate* T_p to 100 °C			3	6	K/s
Time 25 °C to T_p				480	s

All temperatures refer to the center of the package, measured on the top of the component
 *) slope calculation DT/Dt : Dt max. 5 s; fulfillment for the whole T-range

Taping ³⁾

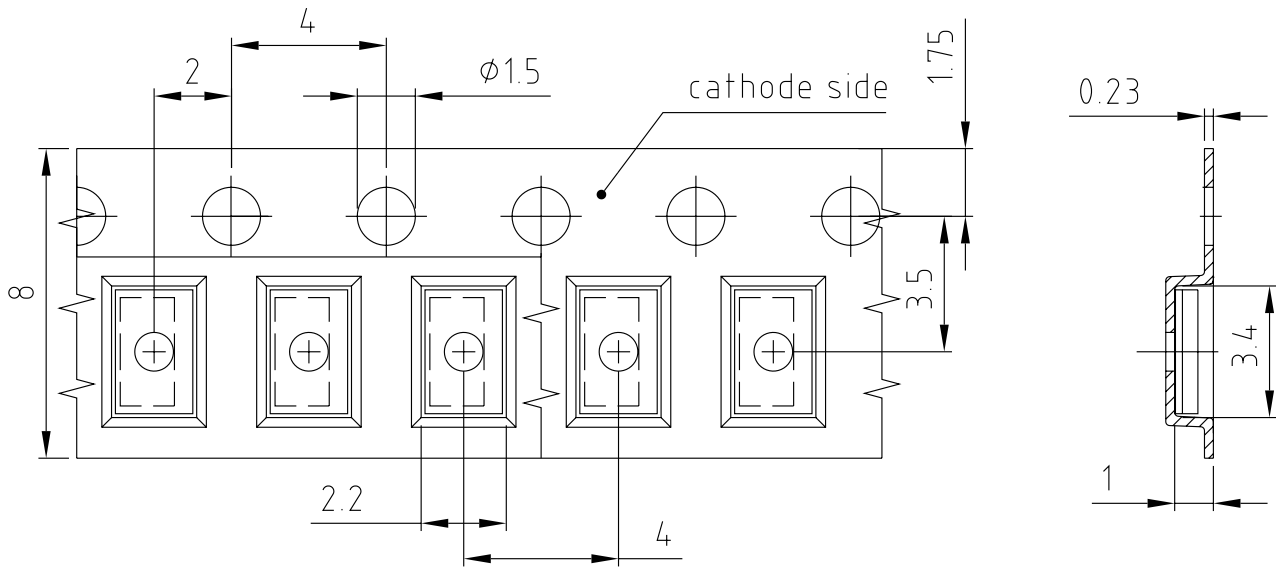

C67062-A0308-B2-03

Tape and Reel ⁴⁾

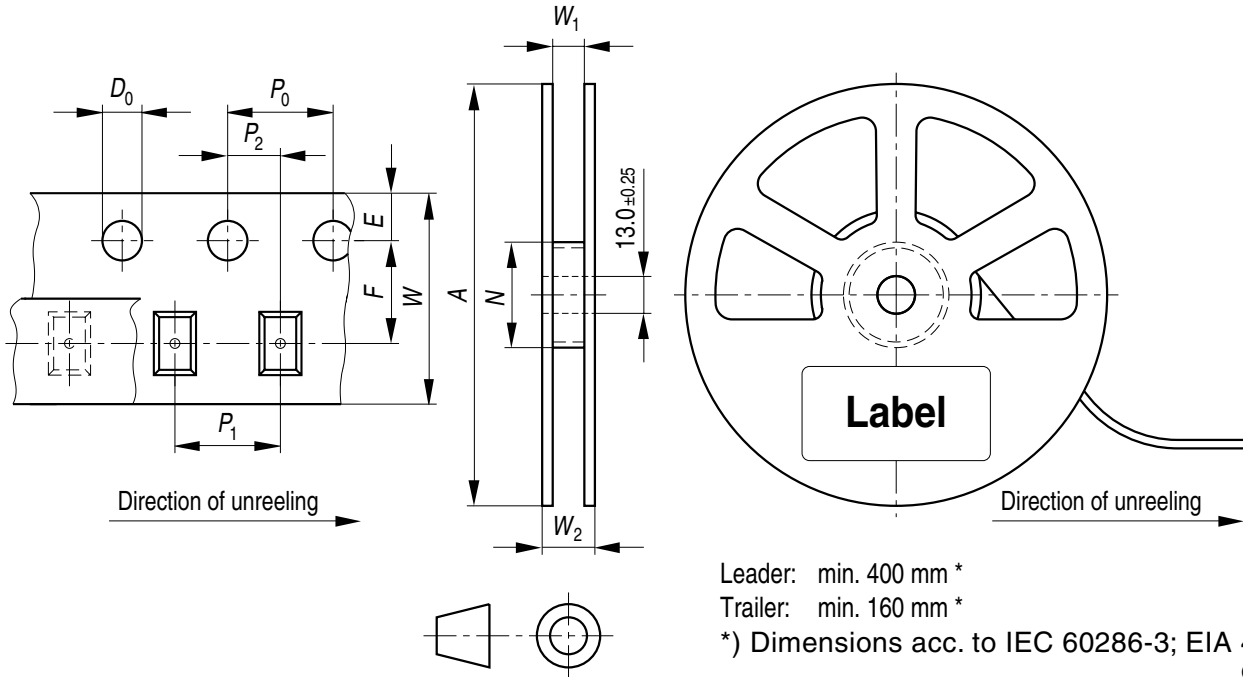

Leader: min. 400 mm *
 Trailer: min. 160 mm *
 *) Dimensions acc. to IEC 60286-3; EIA 481-D
 OHAY0324

Reel Dimensions

A	W	N_{min}	W_1	W_{2max}	Pieces per PU
180 mm	12 + 0.3 / - 0.1 mm	60 mm	12.4 + 2 mm	18.4 mm	3000

Barcode-Product-Label (BPL)

OSRAM Opto Semiconductors LX XXXX BIN1: XX-XX-X-XXX-X

RoHS Compliant

(6P) BATCH NO: 1234567890

(1T) LOT NO: 1234567890 (9D) D/C: 1234

(X) PROD NO: 123456789(Q)QTY: 9999 (G) GROUP: XX-XX-X-X

ML Temp ST
X XXX °C X

Pack: RXX
DEMY XXX
X_X123_1234.1234 X

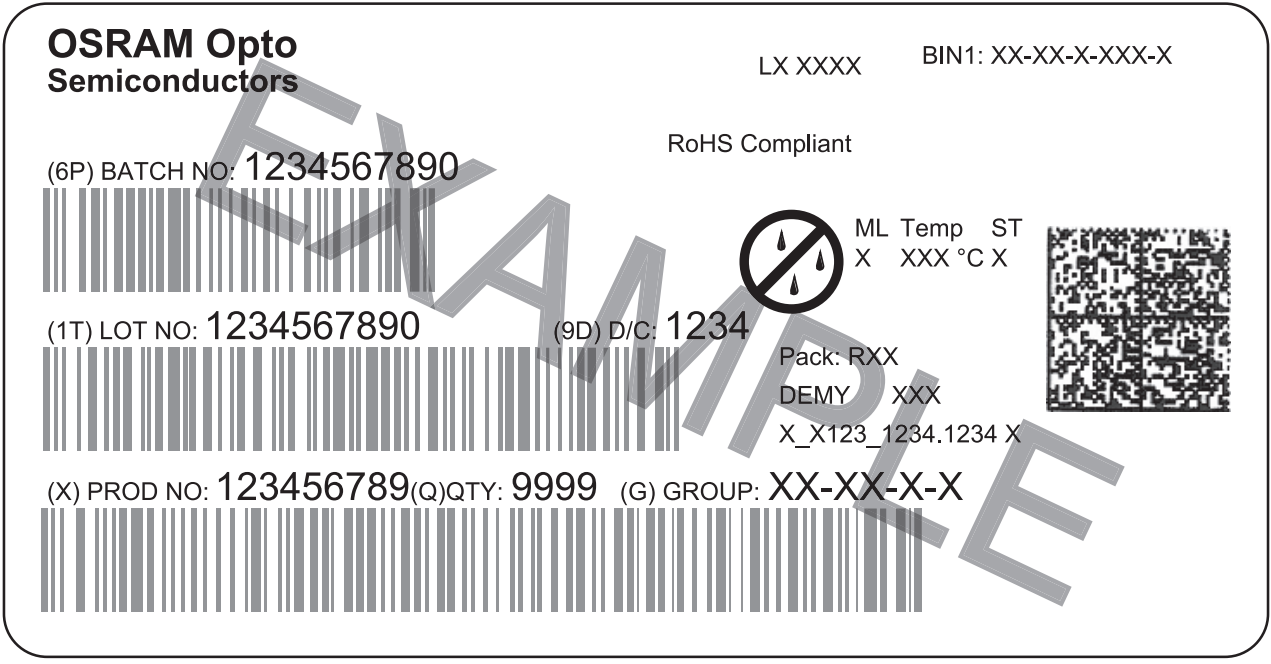

OHA04563

Dry Packing Process and Materials ³⁾

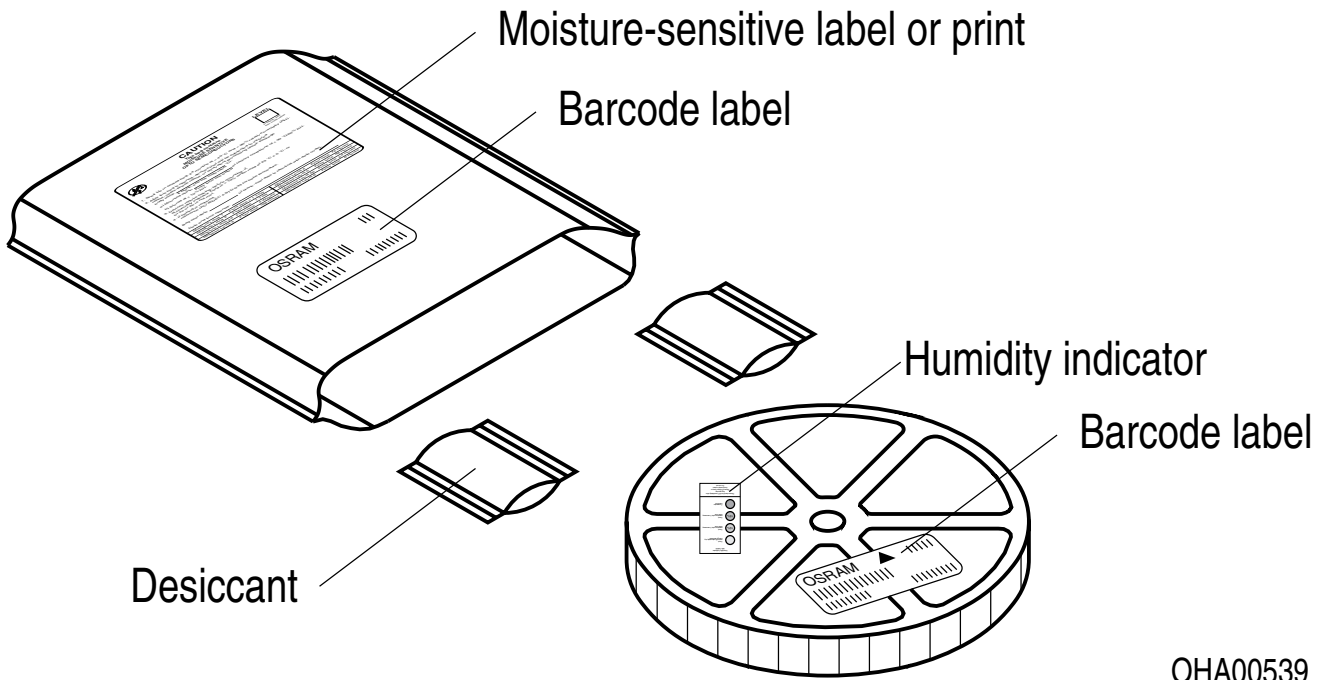

OHA00539

Moisture-sensitive product is packed in a dry bag containing desiccant and a humidity card according JEDEC-STD-033.

Notes

Subcomponents of this device contain, in addition to other substances, metal filled materials including silver. Metal filled materials can be affected by environments that contain traces of aggressive substances. Therefore, we recommend that customers minimize device exposure to aggressive substances during storage, production, and use. Devices that showed visible discoloration when tested using the described tests above did show no performance deviations within failure limits during the stated test duration. Respective failure limits are described in the IEC60810.

For further application related information please visit www.osram-os.com/appnotes

Disclaimer

Attention please!

The information describes the type of component and shall not be considered as assured characteristics. Terms of delivery and rights to change design reserved. Due to technical requirements components may contain dangerous substances.

For information on the types in question please contact our Sales Organization.

If printed or downloaded, please find the latest version on the OSRAM OS website.

Packing

Please use the recycling operators known to you. We can also help you – get in touch with your nearest sales office. By agreement we will take packing material back, if it is sorted. You must bear the costs of transport. For packing material that is returned to us unsorted or which we are not obliged to accept, we shall have to invoice you for any costs incurred.

Product and functional safety devices/applications or medical devices/applications

OSRAM OS components are not developed, constructed or tested for the application as safety relevant component or for the application in medical devices.

OSRAM OS products are not qualified at module and system level for such application.

In case buyer – or customer supplied by buyer – considers using OSRAM OS components in product safety devices/applications or medical devices/applications, buyer and/or customer has to inform the local sales partner of OSRAM OS immediately and OSRAM OS and buyer and /or customer will analyze and coordinate the customer-specific request between OSRAM OS and buyer and/or customer.

Glossary

- 1) **Typical Values:** Due to the special conditions of the manufacturing processes of semiconductor devices, the typical data or calculated correlations of technical parameters can only reflect statistical figures. These do not necessarily correspond to the actual parameters of each single product, which could differ from the typical data and calculated correlations or the typical characteristic line. If requested, e.g. because of technical improvements, these typ. data will be changed without any further notice.
- 2) **Testing temperature:** TA = 25°C (unless otherwise specified)
- 3) **Tolerance of Measure:** Unless otherwise noted in drawing, tolerances are specified with ± 0.1 and dimensions are specified in mm.
- 4) **Tape and Reel:** All dimensions and tolerances are specified acc. IEC 60286-3 and specified in mm.

Revision History

Version	Date	Change
1.0	2020-04-08	Initial Version

Published by OSRAM Opto Semiconductors GmbH EU RoHS and China RoHS compliant product
Leibnizstraße 4, D-93055 Regensburg
www.osram-os.com © All Rights Reserved.



此产品符合欧盟 RoHS 指令的要求；
按照中国的相关法规和标准，不含有毒有害物质或元素。