

## 深圳市晶科鑫实业有限公司

### 样品承认书

客户代码:	
物料名称:	贴片晶振
规格型号:	SMD2016 96.000MHZ 8PF ±10PPM -40~85℃
P N/ SJK:	7F96000E08UCG
环保属性:	<input checked="" type="checkbox"/> RoHS <input checked="" type="checkbox"/> REACH <input checked="" type="checkbox"/> HF <input type="checkbox"/> PAHS <input type="checkbox"/> 其它
版 次:	A1 2017-5-10 初版
湿敏等级:	一级

承 认 签 章					
供 应 商 承 认			( ) 公 司 承 认		
制定	审核	核准	工程师	审核	批准
贺丹斌		黄灏东			
SJK 支持	18682088994 (Mr.黄)		盖章签署		
FAE_EMAIL	<a href="mailto:sjk-fae@q-crystal.com">sjk-fae@q-crystal.com</a>		日 期		
日 期			批示: <input type="checkbox"/> 接受 <input type="checkbox"/> 有条件接受		
备注:					

# QUARTZ CRYSTAL UNIT



SERIES 7F, SEAM SEALED CERAMIC 2.0\*1.6MM SURFACE MOUNT PACKAGE

## 1. FEATURE/产品特征

- I Leadless type
- I High precision characteristic covering up to high frequency range
- I Designed for automatic mounting and reflow soldering
- I Embossed taping specification
- I The best choice of Bluetooth wireless communication sets, DSN, PDA and mobile phone

## 2. ELECTRICAL SPECIFICATIONS/产品技术指标

Output Frequency Range/ 中心频率	96.000000MHz
Mode/振动模式	AT/Fundamental
Frequency Tolerance/ 频率稳定度	±10 ppm max (at 25°C)
Load Capacitance(C <sub>L</sub> )/ 负载电容	8.0 PF
Frequency Stability Over Operating Temperature Characteristics 温度频率稳定度	±10ppm max/-20~70°C
	±30ppm max/-40~85°C
Operating Temperature Range/ 工作温度	-40 °C to +85 °C
Storage Temperature Range/ 储存温度	-40 °C to +125 °C
Shunt Capacitance (C <sub>0</sub> )/静电容	3.0 PF Max
Driver Level (Typical) /激励功率	10μW
Equivalent Series Resistance(ESR)/ 等效电阻	60Ω Max
Aging @25°C 1 <sup>st</sup> year (Max) / 年老化	±3ppm/year

# QUARTZ CRYSTAL UNIT



SERIES 7F, SEAM SEALED CERAMIC 2.0\*1.6MM SURFACE MOUNT PACKAGE

## 3. DIMENSION / 产品规格尺寸 (Units: mm)

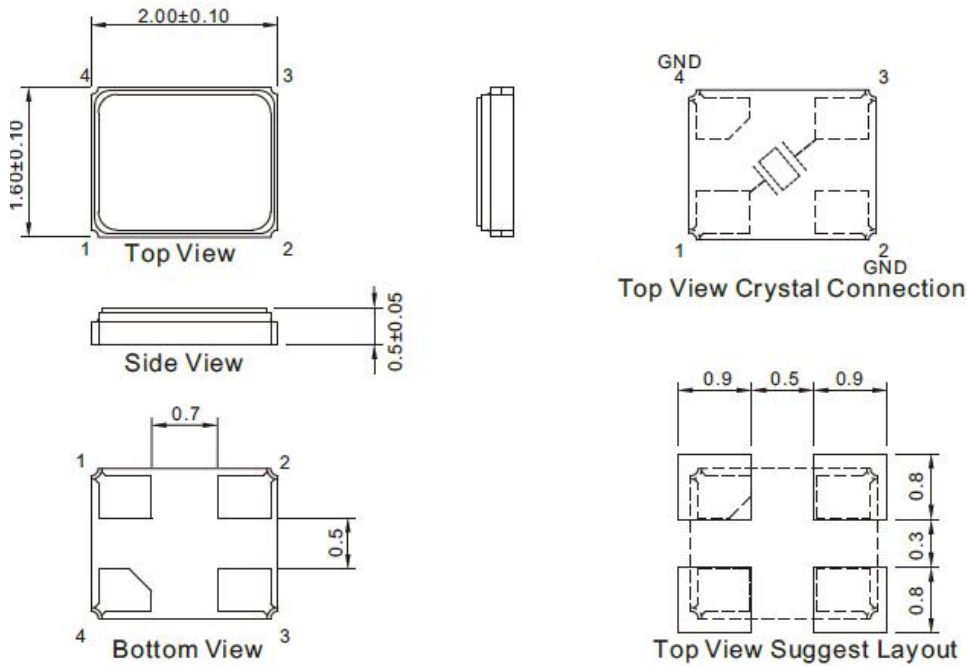

## 4. MARKING / 丝印



## 5. REFLOW CONDITION / 回流焊

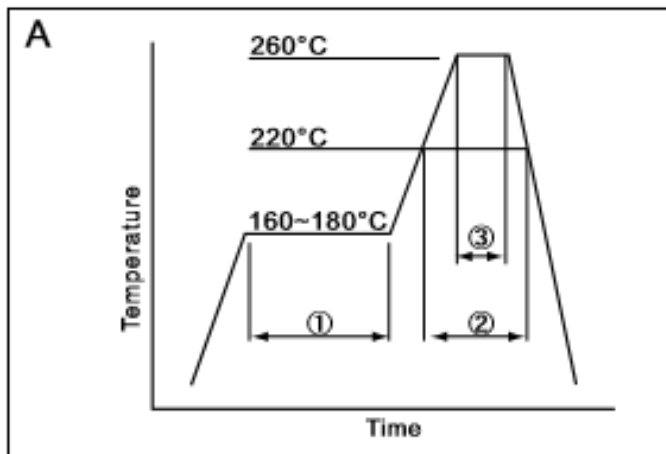

①	Preheat	$160 \sim 180^\circ\text{C}$	120sec.
②	Primary heat	$220^\circ\text{C}$	60sec.
③	Peak	$260^\circ\text{C}$	10sec. max

# QUARTZ CRYSTAL UNIT



SERIES 7F, SEAM SEALED CERAMIC 2.0\*1.6MM SURFACE MOUNT PACKAGE

## 6. STRUCTURE ILLUSTRATION/ 产品内部结构

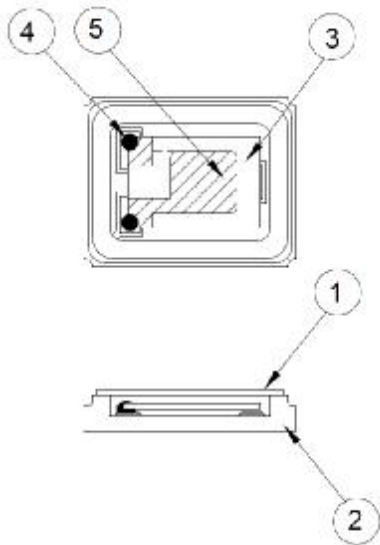

NO	COMPONENTS	MATERIALS	FINISH/SPECIFICATIONS
1	Lid	Kovar (Fe/Co/Ni)	-
2	Base(Package)	Ceramic (Al <sub>2</sub> O <sub>3</sub> ) + Kovar (Fe/Co/Ni)+Pad(Au)	Alumina ceramics
3	Crystal blank	SiO <sub>2</sub>	-
4	Conductive adhesive	Ag	Silicone resin
5	Electrode	Noble Metal	-

## 7. EQUIVALENT CIRCUIT AND OSCILLATION CIRCUIT

等效电路

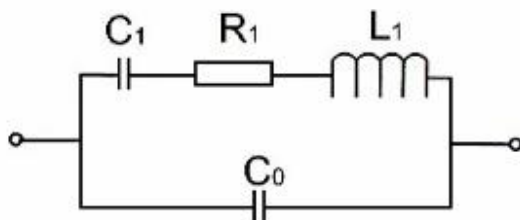

应用电路

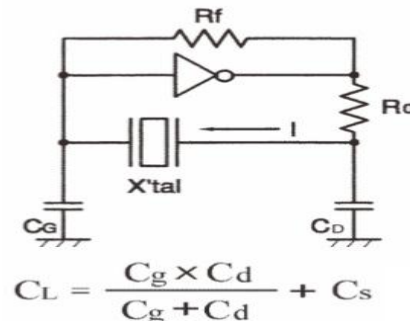

# QUARTZ CRYSTAL UNIT



SERIES 7F, SEAM SEALED CERAMIC 2.0\*1.6MM SURFACE MOUNT PACKAGE

## 8. RELIABILITY TEST SPECIFICATION / 可靠性试验

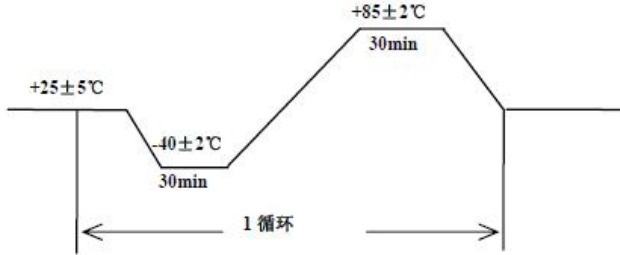
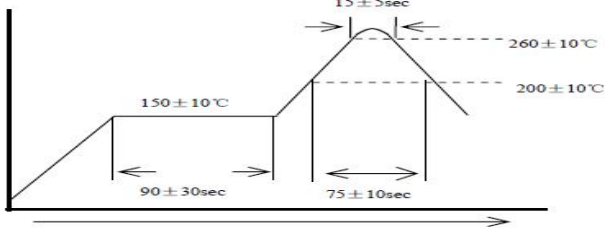
序号	试验项目	试验条件	标准要求
1	跌落	从 55cm 位置高度, 自由跌落在木板上, 连续 3 次	试验前后, 频率变化不超过 $\pm 5\text{ppm}$ 电阻变化不超过 $\pm 15\%$
2	振动	振动频率: 10~55Hz 全振幅: 1.5mm 时间: 每个方位三面(X、Y、Z) 各振动 2 小时	试验前后, 频率变化不超过 $\pm 5\text{ppm}$ 电阻变化不超过 $\pm 15\%$
3	冷热冲击	晶体放入试验箱中, 高低温循环 25 次 低温为 $-40 \pm 3^\circ\text{C}$ 保持 30 分钟, 高温 $85 \pm 2^\circ\text{C}$ 保持 30 分钟, 高、低温每 3 分钟变换一次 	试验前后, 频率变化不超过 $\pm 5\text{ppm}$ 电阻变化不超过 $\pm 15\%$
4	气密性	氦气气压标准: $5 \pm 0.5\text{Kg/cm}^2$ , 氦气加压时间: 120 分钟	漏率标准: $\leq 1 \times 10^{-9}\text{Pa} \cdot \text{m}^3/\text{s}$
5	耐焊接热	波峰温度: $260^\circ\text{C} \pm 10^\circ\text{C}$ 时间: $15 \pm 5$ 秒 	试验前后, 频率变化不超过 $\pm 5\text{ppm}$ 电阻变化不超过 $\pm 15\%$
6	沾锡试验	温度: $260^\circ\text{C} \pm 10^\circ\text{C}$ 浸泡时间: $3 \pm 1$ 秒	引脚沾锡后覆盖面积达 90% 以上
7	高温高湿	温度: $60^\circ\text{C} \pm 2^\circ\text{C}$ 湿度: 90%-95% 保持时间: 240 个小时	1. 试验前后, 频率变化不超过 $\pm 5\text{ppm}$ , 电阻变化不超过 $\pm 15\%$ 2. 制品表面不可生锈
8	高温试验	高温温度: $85^\circ\text{C} \pm 2^\circ\text{C}$ 时间: 240 个小时	试验前后, 频率变化不超过 $\pm 5\text{ppm}$ 电阻变化不超过 $\pm 15\%$
9	低温试验	低温温度: $-40^\circ\text{C} \pm 2^\circ\text{C}$ 时间: 240 个小时	试验前后, 频率变化不超过 $\pm 5\text{ppm}$ 电阻变化不超过 $\pm 15\%$
10	寿命测试	电压 5V 温度: $25^\circ\text{C}$ 时间: 1000 小时	试验前后, 频率变化不超过 $\pm 5\text{ppm}$ 电阻 $15\%$
备注:			

电话: 0755-88352810-837(Mr.huang) 传真: 0755-88353718 <http://www.q-crystal.com>  
公司地址: 深圳市龙岗区天安云谷产业园一期 3 栋 C 座 12 楼 1204~1206 室