

## MOLLY-W

~60° wide beam

### TECHNICAL SPECIFICATIONS:

Dimensions	Ø 69.8 mm
Height	22.1 mm
ROHS compliant	yes ⓘ

### MATERIAL SPECIFICATIONS:

Component	Type	Material	Colour	Finish
MOLLY-W	Single lens	PMMA	clear	







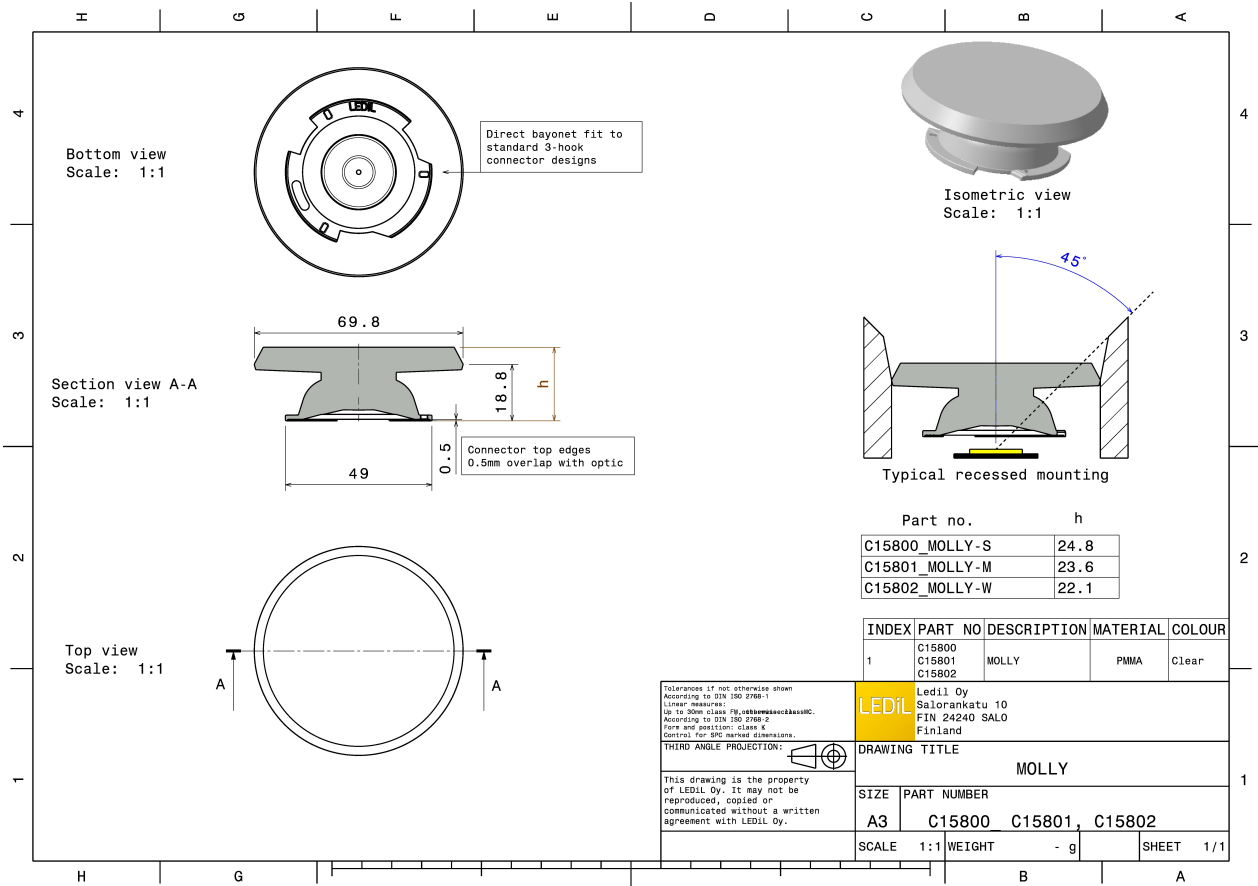

### ORDERING INFORMATION:

Component	Qty in box	MOQ	MPQ	Box weight (kg)
C15802_MOLLY-W » Box size: 476 x 273 x 292 mm	198	36	18	8.1

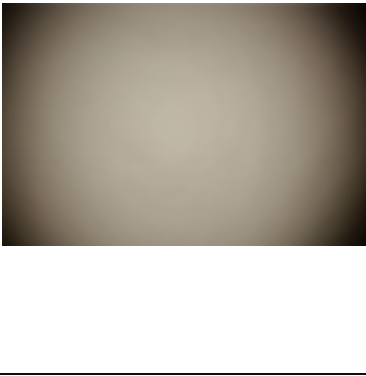
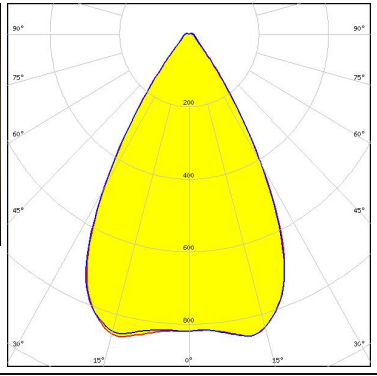

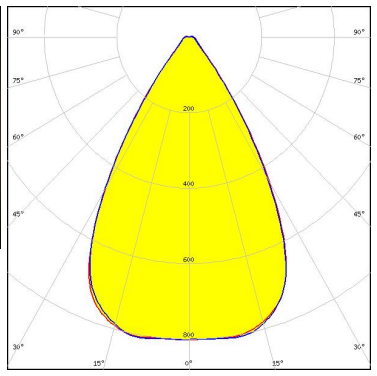
See also our general installation guide: [www.ledil.com/installation\\_guide](http://www.ledil.com/installation_guide)

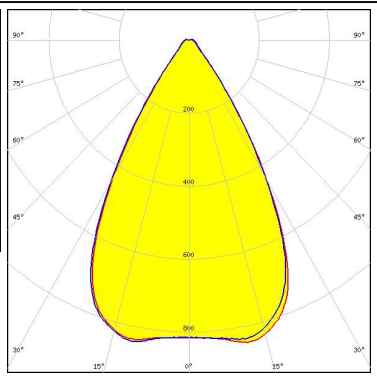
### PHOTOMETRIC DATA (MEASURED):

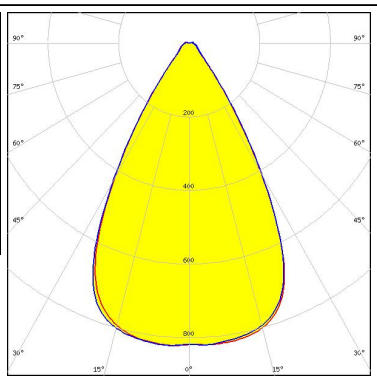
<p></p> <p>LED Vero SE 13            FWHM / FWTM 62.0° / 85.0°            Efficiency 90 %            Peak intensity 0.9 cd/m            LEDs/each optic 1            Light colour White            Required components:            C16402_CLAMP-VEROSE-13-18</p>		
<p></p> <p>LED Vero SE 18            FWHM / FWTM 62.0° / 87.0°            Efficiency 90 %            Peak intensity 0.8 cd/m            LEDs/each optic 1            Light colour White            Required components:            C16402_CLAMP-VEROSE-13-18</p>		
<p></p> <p>LED Vesta TW 15mm DP            FWHM / FWTM 61.0° / 85.0°            Efficiency 90 %            Peak intensity 0.8 cd/m            LEDs/each optic 1            Light colour Tunable White            Required components:            C13658_CLAMP-VERO13-18            Bender Wirth: 482 Typ L2</p>		
<p></p> <p>LED Vesta TW 18mm (31W) DP            FWHM / FWTM 60.0° / 86.0°            Efficiency 89 %            Peak intensity 0.8 cd/m            LEDs/each optic 1            Light colour Tunable White            Required components:            C13584_CLAMP-VERO29            Bender Wirth: 483 Typ L3</p>		

### PHOTOMETRIC DATA (MEASURED):

**bridgelux.**

LED Vesta TW 22mm DP  
 FWHM / FWTM 61.0° / 87.0°  
 Efficiency 88 %  
 Peak intensity 0.8 cd/lm  
 LEDs/each optic 1  
 Light colour Tunable White

Required components:  
 C13584\_CLAMP-VERO29  
 Bender Wirth: 494 Typ L3



**CITIZEN**

LED CLL03x/CLU03x  
 FWHM / FWTM 61.0° / 86.0°  
 Efficiency 89 %  
 Peak intensity 0.9 cd/lm  
 LEDs/each optic 1  
 Light colour White

Required components:  
 Bender Wirth: 433 Typ L1



**CITIZEN**

LED CLL03x/CLU03x  
 FWHM / FWTM 58.0° / 83.0°  
 Efficiency 90 %  
 Peak intensity 0.9 cd/lm  
 LEDs/each optic 1  
 Light colour White

Required components:  
 C16791\_CLAMP-Z45-A  
 TE Connectivity: 2325807-3

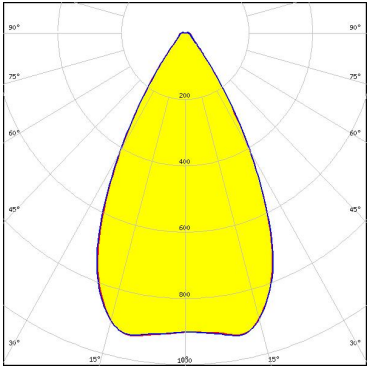
**CITIZEN**

LED LCN-C02B (Tunable White)  
 FWHM / FWTM 62.0° / 84.0°  
 Efficiency 89 %  
 Peak intensity 0.9 cd/lm  
 LEDs/each optic 1  
 Light colour White

Required components:  
 C13658\_CLAMP-VERO13-18  
 Bender Wirth: 481 Typ L2

### PHOTOMETRIC DATA (MEASURED):

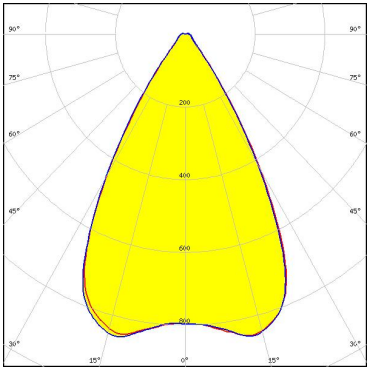
#### CREE → LED

LED CMA1840  
FWHM / FWTM 64.0° / 87.0°  
Efficiency 91 %  
Peak intensity 0.8 cd/m  
LEDs/each optic 1  
Light colour White  
Required components:  
C14123\_CLAMP-CXA15-18

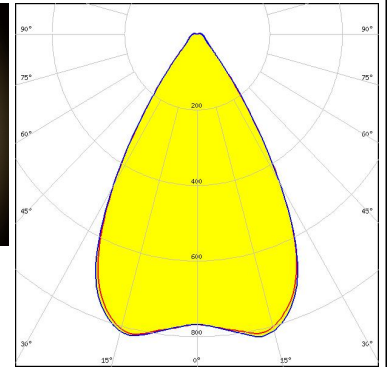
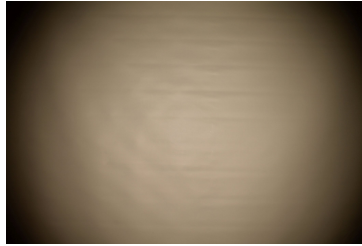

#### CREE → LED

LED CMA2550  
FWHM / FWTM 63.0° / 88.0°  
Efficiency 89 %  
Peak intensity 0.8 cd/m  
LEDs/each optic 1  
Light colour White  
Required components:  
C14036\_CLAMP\_CXA25-30

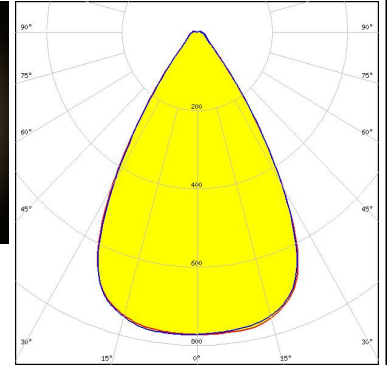
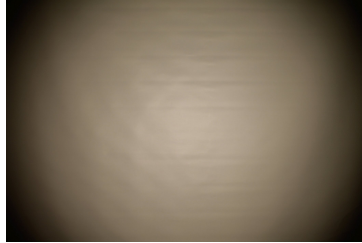

#### CREE → LED

LED CMA3090  
FWHM / FWTM 64.0° / 89.0°  
Efficiency 89 %  
Peak intensity 0.8 cd/m  
LEDs/each optic 1  
Light colour White  
Required components:  
C14036\_CLAMP\_CXA25-30

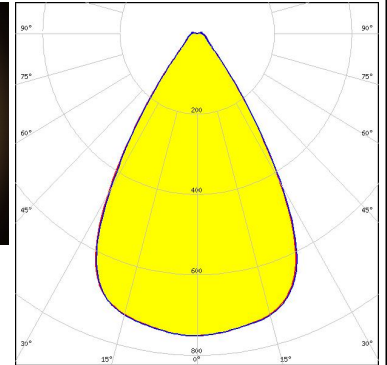

#### CREE → LED

LED CMT14xx  
FWHM / FWTM 60.0° / 83.0°  
Efficiency 90 %  
Peak intensity 0.9 cd/m  
LEDs/each optic 1  
Light colour White  
Required components:  
C13658\_CLAMP-VERO13-18  
Bender Wirth: 434 Typ L1

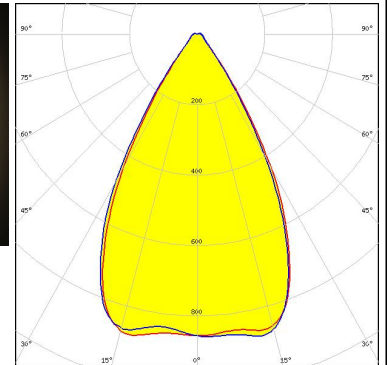

#### PHOTOMETRIC DATA (MEASURED):

##### CREE LED

LED CMT19xx  
 FWHM / FWTM 61.0° / 85.0°  
 Efficiency 90 %  
 Peak intensity 0.8 cd/m  
 LEDs/each optic 1  
 Light colour White  
 Required components:  
 C13658\_CLAMP-VERO13-18  
 Bender Wirth: 477 Typ L1

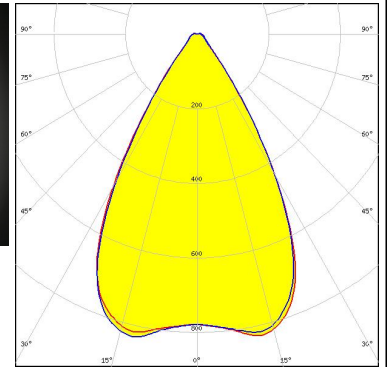
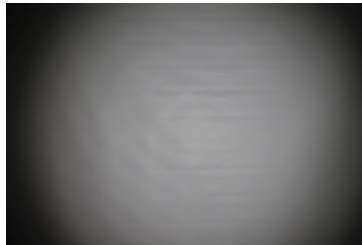

##### CREE LED

LED CMT28xx  
 FWHM / FWTM 61.0° / 87.0°  
 Efficiency 88 %  
 Peak intensity 0.8 cd/m  
 LEDs/each optic 1  
 Light colour White  
 Required components:  
 C13584\_CLAMP-VERO29  
 Bender Wirth: 471 Typ L3

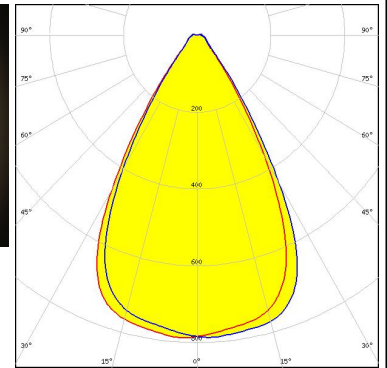
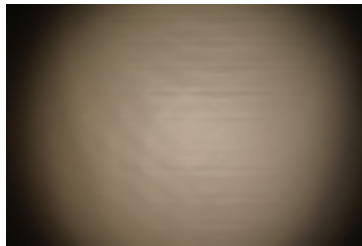

##### CREE LED

LED CXA/B 15xx  
 FWHM / FWTM 61.0° / 84.0°  
 Efficiency 90 %  
 Peak intensity 0.9 cd/m  
 LEDs/each optic 1  
 Light colour White  
 Required components:  
 C14123\_CLAMP-CXA15-18

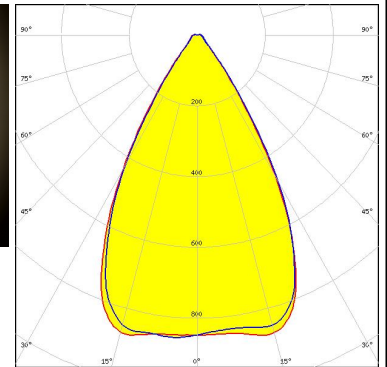
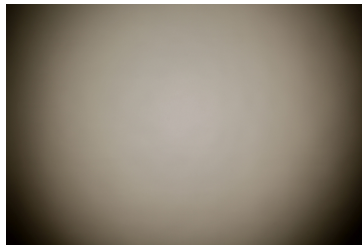

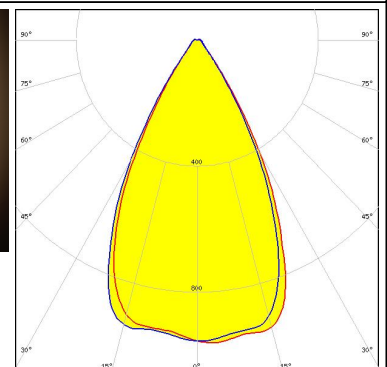
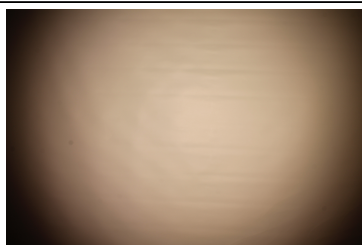

##### LUMILEDS

LED LUXEON CoB 1204HD  
 FWHM / FWTM 57.0° / 80.0°  
 Efficiency 89 %  
 Peak intensity 1 cd/m  
 LEDs/each optic 1  
 Light colour White  
 Required components:  
 TE Connectivity: 2213382-2 + OPTIC CLIP Z50 TYPE1 2213194-1

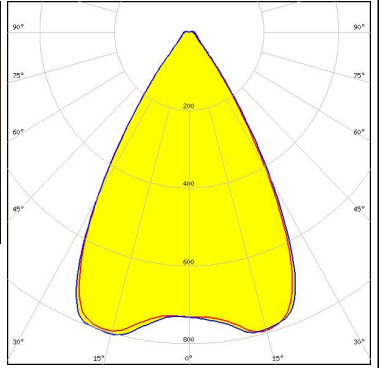
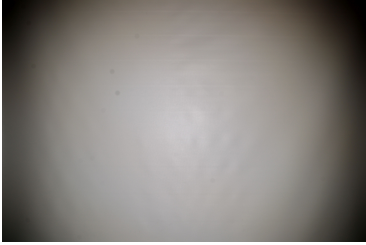
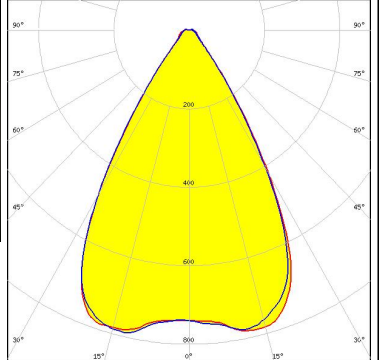

#### PHOTOMETRIC DATA (MEASURED):

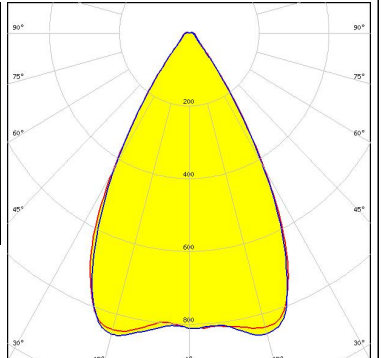
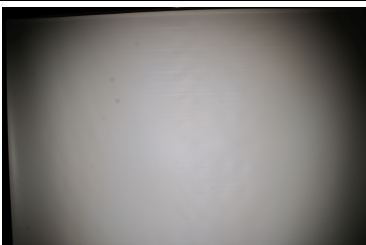
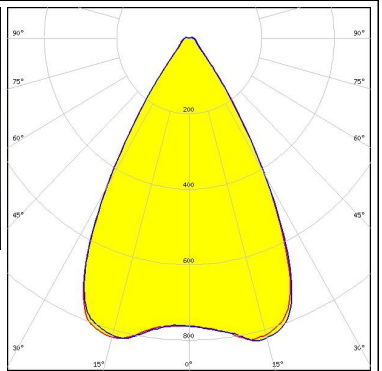
<p><b>LUMINUS</b></p> <p>LED CDM-14 (Dim-To-Warm)</p> <p>FWHM / FWTM 64.0° / 86.0°</p> <p>Efficiency 89 %</p> <p>Peak intensity 0.8 cd/m</p> <p>LEDs/each optic 1</p> <p>Light colour White</p> <p>Required components: C13658_CLAMP-VERO13-18 Bender Wirth: 491 Typ L2</p>		
<p><b>LUMINUS</b></p> <p>LED CDM-18 (Dim-To-Warm)</p> <p>FWHM / FWTM 63.0° / 87.0°</p> <p>Efficiency 89 %</p> <p>Peak intensity 0.8 cd/m</p> <p>LEDs/each optic 1</p> <p>Light colour White</p> <p>Required components: C13658_CLAMP-VERO13-18 Bender Wirth: 491 Typ L2</p>		
<p><b>LUMINUS</b></p> <p>LED CDM-9 (Dim-To-Warm)</p> <p>FWHM / FWTM 61.0° / 83.0°</p> <p>Efficiency 89 %</p> <p>Peak intensity 0.9 cd/m</p> <p>LEDs/each optic 1</p> <p>Light colour White</p> <p>Required components: C13658_CLAMP-VERO13-18 Bender Wirth: 490 Typ L1</p>		
<p><b>LUMINUS</b></p> <p>LED CTM-14 (Tunable White)</p> <p>FWHM / FWTM 62.0° / 85.0°</p> <p>Efficiency 88 %</p> <p>Peak intensity 0.8 cd/m</p> <p>LEDs/each optic 1</p> <p>Light colour White</p> <p>Required components: C13584_CLAMP-VERO29 Bender Wirth: 442 Typ L3</p>		

### PHOTOMETRIC DATA (MEASURED):



LED CTM-14 RGBW  
 FWHM / FWTM 61.0° / 84.0°  
 Efficiency 89 %  
 Peak intensity 0.8 cd/lm  
 LEDs/each optic 1  
 Light colour RGBW  
 Required components:  
 C13584\_CLAMP-VERO29  
 Bender Wirth: 500 Typ L3-1

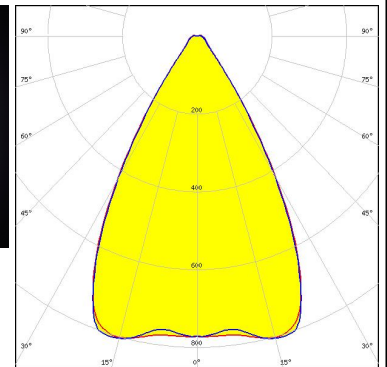
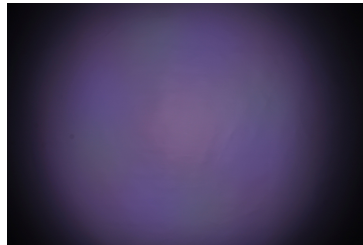

LED CTM-22 (Tunable White)  
 FWHM / FWTM 62.0° / 88.0°  
 Efficiency 87 %  
 Peak intensity 0.7 cd/lm  
 LEDs/each optic 1  
 Light colour White  
 Required components:  
 C13584\_CLAMP-VERO29  
 Bender Wirth: 494 Typ L3

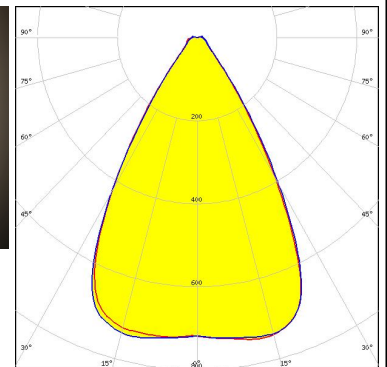
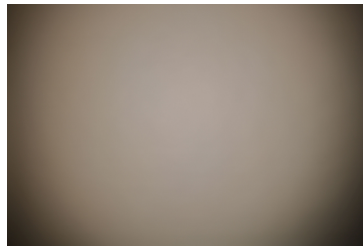

LED NVCWJ024Z-V1MT: COB J-Type Tunable White  
 FWHM / FWTM 60.0° / 82.0°  
 Efficiency 89 %  
 Peak intensity 0.9 cd/lm  
 LEDs/each optic 1  
 Light colour White  
 Required components:  
 C13658\_CLAMP-VERO13-18  
 Bender Wirth: 498 Typ L2

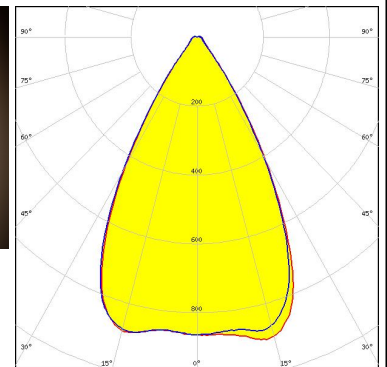
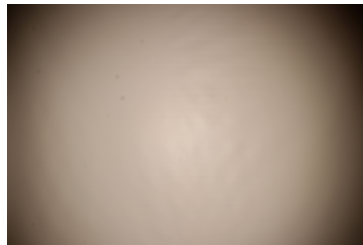

LED PrevaLED Core G7 L15 H1  
 FWHM / FWTM 57.0° / 82.0°  
 Efficiency 90 %  
 Peak intensity 1 cd/lm  
 LEDs/each optic 1  
 Light colour White  
 Required components:  
 C16685\_CLAMP-PRV-A

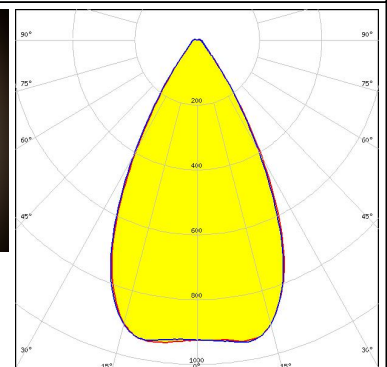
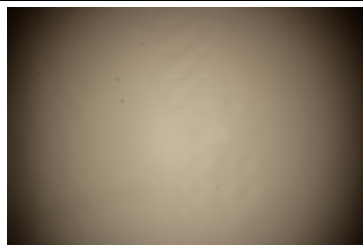



#### PHOTOMETRIC DATA (MEASURED):

### PHILIPS

LED Fortimo SLM L13 CoB  
 FWHM / FWTM 60.0° / 83.0°  
 Efficiency 89 %  
 Peak intensity 0.9 cd/lm  
 LEDs/each optic 1  
 Light colour White  
 Required components:  
 TE Connectivity: 2213130-2 + OPTIC CLIP Z50 TYPE1 2213194-1



### PHILIPS

LED Fortimo SLM L15 + SLM holder  
 FWHM / FWTM 57.0° / 81.0°  
 Efficiency 89 %  
 Peak intensity 0.9 cd/lm  
 LEDs/each optic 1  
 Light colour White  
 Required components:  
 TE Connectivity: OPTIC CLIP Z50 TYPE1 2213194-1

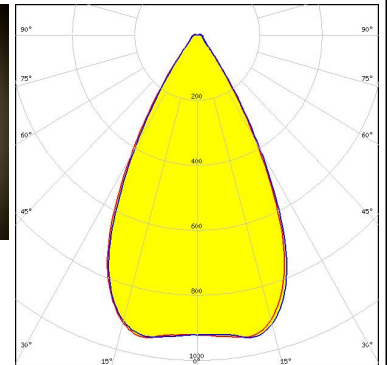
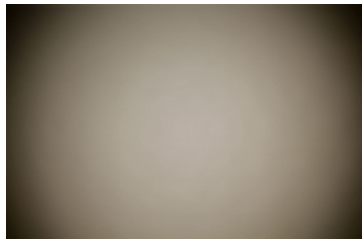

### PHILIPS

LED Fortimo SLM L15 CoB  
 FWHM / FWTM 60.0° / 83.0°  
 Efficiency 88 %  
 Peak intensity 0.9 cd/lm  
 LEDs/each optic 1  
 Light colour White  
 Required components:  
 TE Connectivity: 2213130-2 + OPTIC CLIP Z50 TYPE1 2213194-1

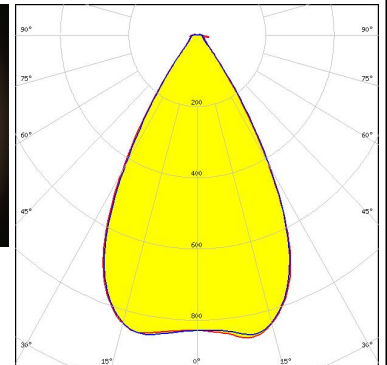
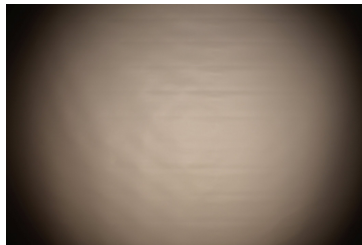

### SAMSUNG

LED LC035T (Tunable white)  
 FWHM / FWTM 62.0° / 88.0°  
 Efficiency 89 %  
 Peak intensity 0.8 cd/lm  
 LEDs/each optic 1  
 Light colour Tunable White  
 Required components:  
 C13584\_CLAMP-VERO29  
 Bender Wirth: 502 Typ L3

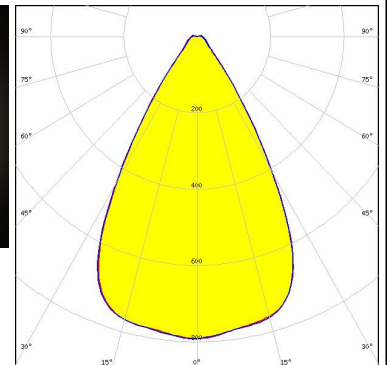
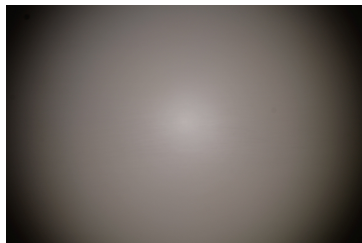

## PHOTOMETRIC DATA (MEASURED):

### XICATO

LED XTM - 19mm LES  
FWHM / FWTM 60.0° / 85.0°  
Efficiency 90 %  
Peak intensity 0.9 cd/lm  
LEDs/each optic 1  
Light colour White  
Required components:  
C16491\_XTM-ADAPTER-50-A

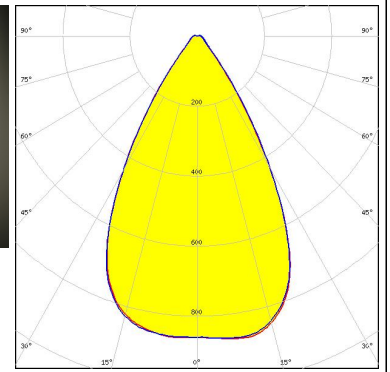

#### PHOTOMETRIC DATA (SIMULATED):

bridgelux.

LED V9 HD  
 FWHM / FWTM 58.0° / 77.0°  
 Efficiency 90 %  
 Peak intensity 1 cd/lm  
 LEDs/each optic 1  
 Light colour White  
 Required components:  
 C13658\_CLAMP-VERO13-18  
 Bender Wirth: 496 Typ L1

bridgelux.

LED VERO13  
 FWHM / FWTM 55.0° / 75.0°  
 Efficiency 90 %  
 Peak intensity 1.1 cd/lm  
 LEDs/each optic 1  
 Light colour White  
 Required components:  
 C13658\_CLAMP-VERO13-18

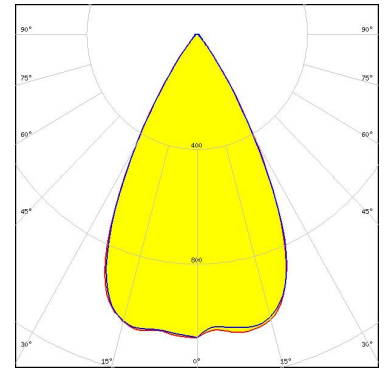

## CITIZEN

LED CLL02x/CLU02x (LES10)  
 FWHM / FWTM 54.0° / 73.0°  
 Efficiency 89 %  
 Peak intensity 1.2 cd/lm  
 LEDs/each optic 1  
 Light colour White  
 Required components:  
 Bender Wirth: 434 Typ L1

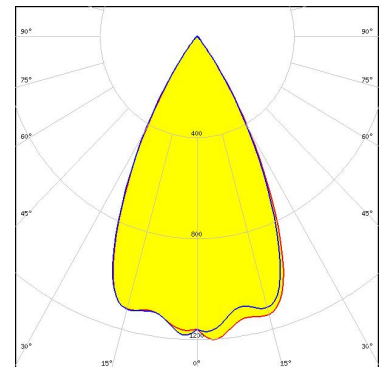

CREE LED

LED CXA/B 1816 & CXA/B 1820 & CXA 1850  
 FWHM / FWTM 58.0° / 78.0°  
 Efficiency 90 %  
 Peak intensity 1.1 cd/lm  
 LEDs/each optic 1  
 Light colour White  
 Required components:  
 C14123\_CLAMP-CXA15-18

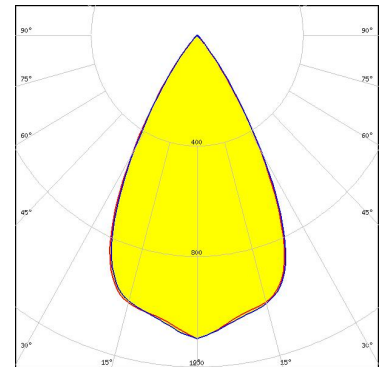

### PHOTOMETRIC DATA (SIMULATED):



LED CXA/B 25xx  
FWHM / FWTM 57.0° / 77.0°  
Efficiency %  
Peak intensity 1.1 cd/lm  
LEDs/each optic 1  
Light colour White  
Required components:  
C14036\_CLAMP\_CXA25-30

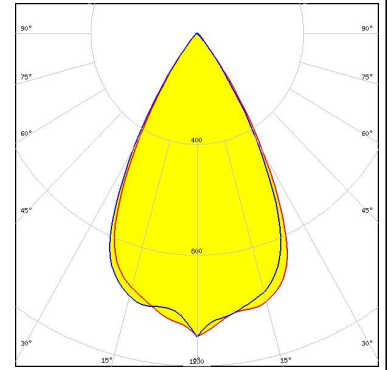

LED CTM-18 (Tunable White)  
FWHM / FWTM 54.0° / 75.0°  
Efficiency 80 %  
Peak intensity 1 cd/lm  
LEDs/each optic 1  
Light colour White  
Required components:  
C13658\_CLAMP-VERO13-18

### GENERAL INFORMATION:

NOTE: The typical beam angle will be changed by different color, chip size and chip position tolerance. The typical total beam angle is the full angle measured where the luminous intensity is half of the peak value.

Due to use of high power COB's with this product, special attention to proper thermal design is highly recommended. LEDiL has no liability for direct, indirect or consecutive damages arising from the LEDiL products being used outside of the recommended temperature range.

### MATERIALS:

As part of our continuous research and improvement processes, and to ensure the best possible quality and availability of our products, LEDiL reserves the right to change material grades without notice.

### PRODUCT DATA USER AGREEMENT AND DISCLAIMER:

The measured data in the provided downloadable LEDiL Product Datasheets and Mechanical 2D-Drawings is rounded and provided as reference for planning. LEDiL Oy's optical specifications have been verified by conducting performance testing of the products in accordance with the company's quality system. The reported data are averaged results of multiple measurements with typical variation. LEDiL Oy reserves the right to without prior notification make changes and improvements to its products.

LEDiL Oy assumes neither warranty, nor guarantee nor any other liability of any kind for the contents and correctness of the provided data. The provided data has been generated with highest diligence but the provided data may in reality not represent the complete possible variation range of all intrinsic parameters. Therefore, in certain cases a deviation from the provided data could occur.

LEDiL Oy reserves the right to undertake technical changes of its products without further notification which could lead to changes in the provided data. LEDiL Oy assumes no liability of any kind for the possible deviation from any provided data or any other damage resulting from the usage of the provided data.

The user agrees to this disclaimer and user agreement with the download or usage of the provided files.

#### LEDiL Oy

Joensuunkatu 13  
FI-24240 SALO  
Finland

#### LEDiL Inc.

228 West Page Street  
Suite D  
Sycamore IL 60178  
USA

#### Ledil Optics Technology (Shenzhen) Co., Ltd.

# 405 , Block B  
Casic Motor Building  
Shenzhen 518057  
P.R.CHINA

#### Local sales and technical support

[www.ledil.com/  
where\\_to\\_buy](http://www.ledil.com/where_to_buy)

#### Shipping locations

Salo, Finland  
Hong Kong, China

#### Distribution Partners

[www.ledil.com/  
where\\_to\\_buy](http://www.ledil.com/where_to_buy)

# Mouser Electronics

Authorized Distributor

Click to View Pricing, Inventory, Delivery & Lifecycle Information:

Ledil:

[C15802\\_MOLLY-W](#)