

RPC Series



- Proportional controller
- Ratings from 15A to 40A @ 480 VAC
- 500k or 1M Ohm potentiometer control
- KS100 Protective Cover Included
- For use with resistive loads only

PRODUCT SELECTION

Description	15 A	25 A	40 A
120 VAC	RPC1215	RPC1225	RPC1240
240 VAC	RPC2415	RPC2425	RPC2440
480 VAC	RPC4815	RPC4825	RPC4840

OUTPUT SPECIFICATIONS (voltage) (1)

Description	120 VAC	240 VAC	480 VAC
Operating Voltage (47-63Hz) [Vrms]	90-130	200-240	400-480
Transient Overvoltage [Vpk]	400	600	1200
Maximum Off-State Leakage Current @ Rated Voltage [mArms]	10	7	3
Minimum Off-State dv/dt @ Maximum Rated Voltage [V/μsec] (2)	5000	500	500
Snubber (Internal)	yes	yes	no

OUTPUT SPECIFICATIONS (current) (1)

Description	15 A	25 A	40 A
Maximum Load Current [Arms] (3)	15	25	40
Minimum Load Current [mArms]	70	80	90
Maximum Surge Current (16.6ms) [Apk]	150	250	625
Maximum On-State Voltage Drop @ Rated Current [Vpk]	1.6	1.6	1.6
Thermal Resistance Junction to Case (Rjc) [°C/W]	1.48	1.02	0.63
Maximum I ² t for Fusing (8.3 msec) [A ² sec]	94	260	1620

INPUT SPECIFICATIONS (1)

Description	RPC12XX	RPC24XX	RPC48XX
Variable Resistor Size (4)	150K (1W)	1M (1/2W)	1M (1/2W)

GENERAL SPECIFICATIONS

Description	
Minimum Power Factor (with Maximum Load)	0.6
Dielectric Strength, Input/Output/Base (50/60Hz)	2500 Vrms
Ambient Operating Temperature Range	-30 to 80 °C
Ambient Storage Temperature Range	-40 to 125 °C
Weight (typical)	3.2 oz (90g)
Encapsulation	Thermally conductive Epoxy
Terminals	Screws and saddle Clamps Furnished, Unmounted
Recommended Terminal Screw Torque Range:	6-32 Screws -10 in. lbs. 8-32 and 10-32 Screws -20 in. lbs. (Screws dry without grease)

GENERAL NOTES

- 1) All parameters at 25°C unless otherwise specified.
- 2) Off-State dv/dt test method per EIA/NARM standard RS-443
- 3) Heat sinking required, see derating curves.
- 4) Potentiometer should be line voltage rated.

MECHANICAL SPECIFICATIONS

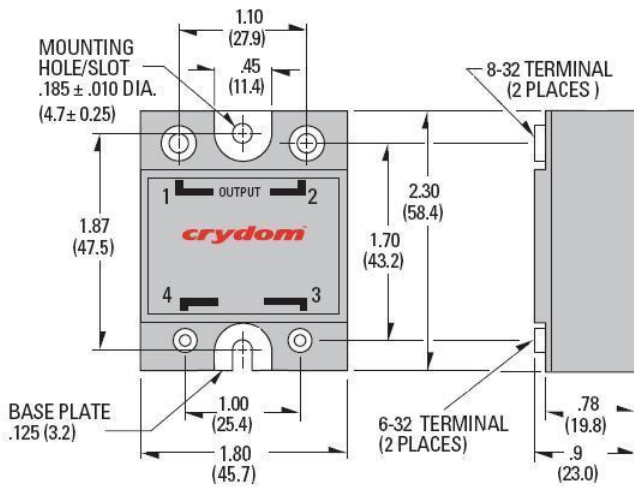

All dimensions are in inches (millimeters)

WIRING DIAGRAM



All terminals are at Line Voltage Potential.

THERMAL DERATE INFORMATION

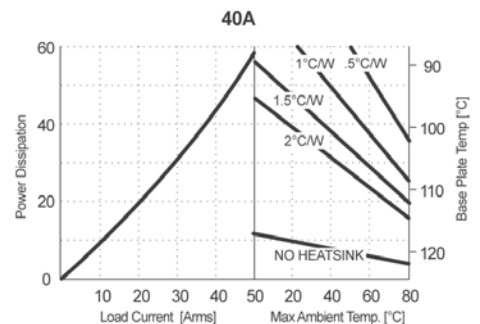
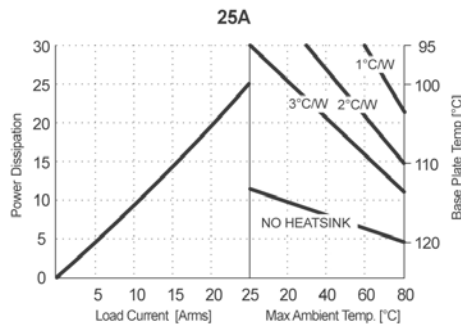
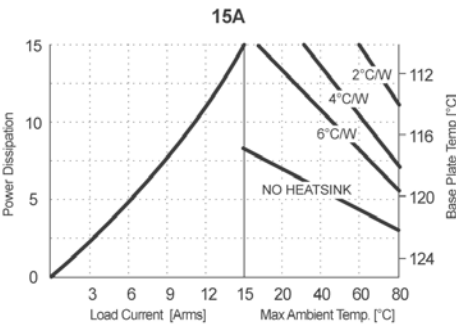

PERCENTAGE ON VS INPUT RESISTANCE

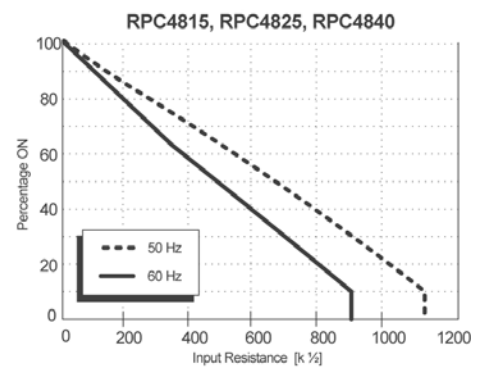
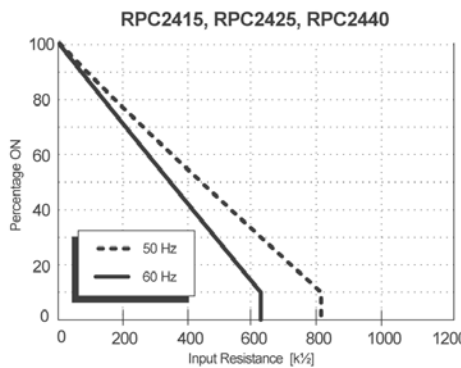
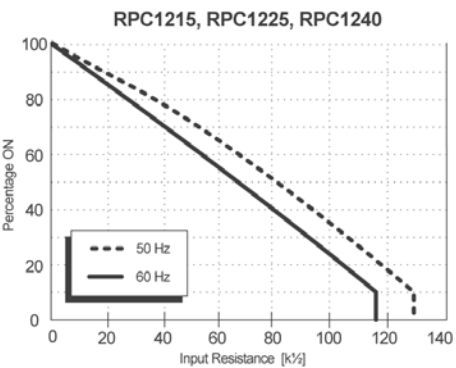

AGENCY APPROVALS



Rev. 091112

 WARNING / AVERTISSEMENT / WARNUNG / ADVERTENCIA / AVVERTENZA / AVISO		
RISK OF MATERIAL DAMAGE AND HOT ENCLOSURE <ul style="list-style-type: none"> The product's side panels may be hot, allow the product to cool before touching. Follow proper mounting instructions including torque values. Do not allow liquids or foreign objects to enter this product. <p>Failure to follow these instructions can result in serious injury, or equipment damage.</p>	RISQUE DE DOMMAGE MATERIEL ET DE SURCHAUFFE DU BOITIER <ul style="list-style-type: none"> Les panneaux latéraux du produit peuvent être chauds. Laisser le produit refroidir avant de le toucher. Respecter les consignes de montage, et notamment les couples de serrage. Ne pas laisser pénétrer de liquide ni de corps étrangers à l'intérieur du produit. <p>Le non-respect de cette directive peut entraîner, des lésions corporelles graves ou des dommages matériels.</p>	GEFAHR VON MATERIALSCHÄDEN UND GEHÄUSEERHITZUNG <ul style="list-style-type: none"> Die Seitenwände können heiß sein. Lassen Sie das Produkt abkühlen, bevor Sie es berühren. Beachten Sie die Montageanweisungen, Führen Sie keine Flüssigkeiten oder Fremdkörper in das Produkt ein. <p>Die Nichtbeachtung dieser Anweisung kann Körperverletzung oder Materialschäden zur Folge haben.</p>
RIESGO DE DAÑOS MATERIALES Y DE SOBRECALENTAMIENTO DE LA UNIDAD <ul style="list-style-type: none"> Los paneles laterales del producto pueden estar calientes. Esperar que el producto se enfríe antes de tocarlo. Respetar las instrucciones de montaje, y en particular los pares de apretado. No dejar que penetren líquidos o cuerpos extraños en el producto. <p>Si no se respetan estas precauciones pueden producirse graves lesiones, daños materiales.</p>	RISCHIO DI DANNI MATERIALI E D'INVOLUCRO CALDO <ul style="list-style-type: none"> I pannelli laterali dell'apparecchio possono scottare; lasciar quindi raffreddare il prodotto prima di toccarlo. Seguire le istruzioni di montaggio corrette. Non far entrare liquidi o oggetti estranei in questo apparecchio. <p>La mancata osservanza di questa precauzione può causare gravi rischi per l'incolumità personale o danni alle apparecchiature.</p>	RISCO DE DANO MATERIAL E DE AQUECIMENTO CALDO <ul style="list-style-type: none"> Os painéis laterais do produto podem estar quentes; dê tempo ao produto para arrefecer antes de lhe tocar. Siga devidamente as instruções de montagem. Não permita a entrada de líquidos e de objectos estranhos no produto. <p>A não observância destas precauções pode provocar a morte, ferimentos graves ou danos materiais.</p>

 DANGER / PELIGRO / DANGER /GEFAHR / PERICOLO / PERIGO					
HAZARD OF ELECTRIC SHOCK, EXPLOSION, OR ARC FLASH. <ul style="list-style-type: none"> Disconnect all power before installing or working with this equipment. Verify all connections and replace all covers before turning on power. <p>Failure to follow these instructions will result in death or serious injury.</p>	RIESGO DE DESCARGA ELECTRICA O EXPLOSION. <ul style="list-style-type: none"> Desconectar todos los suministros de energia a este equipo antes de trabajar con este equipo. Verificar todas las conexiones y colocar todas las tapas antes de energizar el equipo. <p>El incumplimiento de estas instrucciones puede provocar la muerte o lesiones serias.</p>	RISQUE DE DESCARGE ELECTRIQUE OU EXPLOSION <ul style="list-style-type: none"> Eteindre toutes les sources d'énergie de cet appareil avant de travailler dessus de cet appareil Vérifier tous connections, et remettre tous couverts en place avant de mettre sous <p>De non-suivi de ces instructions provoquera la mort ou des lésions sérieuses.</p>	GEFAHR EINES ELEKTRISCHE N SCHLAGES ODER EINER EXPLOSION. <ul style="list-style-type: none"> Stellen Sie jeglichen Strom ab, der dieses Gerät versorgt, bevor Sie an dem Gerät Arbeiten durchführen Vor der Inbetriebnahme alle Anschlüsse überprüfen und alle Gehäuseteile montieren. <p>Unterlassung dieser Anweisungen können zum Tode oder zu schweren Verletzungen führen.</p>	RISCHIO DI SCOSSA ELETTRICA O DELL'ESPLOSIONE. <ul style="list-style-type: none"> Spenga tutta l'alimentazione e che fornisce questa apparecchiatura prima del lavorare a questa apparecchiatura Verificare tutti i collegamenti e sostituire tutte le coperture prima della rotazione sull'alimentazione <p>L'omissione di seguire queste istruzioni provocherà la morte o di lesioni serie</p>	RISCO DE DESCARGA ELÉTRICA OU EXPLOÇÃO <ul style="list-style-type: none"> Desconectar o equipamento de toda a energia antes de instalar ou trabalhar com este equipamento Verificar todas as conexões e recolocar todas as tampas antes de religar o equipamento <p>O não cumprimento destas instruções pode levar a morte ou lesões sérias.</p>

ANNEX - ENVIROMENTAL INFORMATION

The environmental information disclosed in this annex including the EIP Pollution logo are in compliance with People's Republic of China Electronic Industry Standard SJ/T11364 – 2006, Marking for Control of Pollution Caused by Electronic Information Products.

Part Name	Toxic or hazardous Substance and Elements					
	Lead (Pb)	Mercury (Hg)	Cadmium (Cd)	Hexavalent Chromium (Cr (VI))	Polybrominated biphenyls (PBB)	Polybrominated diphenyl ethers (PBDE)
Semiconductor die	X	O	O	O	O	O
Solder	X	O	O	O	O	O

此附件所标示的包括电子信息产品污染图标的环保信息符合中华人民共和国电子行业标准 **SJ/T11364 - 2006**, 电子信息产品污染控制标识要求



部件名称	有毒有害物质或元素					
	铅 (Pb)	汞 (Hg)	镉 (Cd)	六价铬 (Cr (VI))	多溴联苯 (PBB)	多溴二苯醚 (PBDE)
半导体芯片	X	O	O	O	O	O
焊接点	X	O	O	O	O	O

Mouser Electronics

Authorized Distributor

Click to View Pricing, Inventory, Delivery & Lifecycle Information:

[Sensata:](#)

[RPC1225](#) [RPC1215](#) [RPC1240](#) [RPC2415](#) [RPC2425](#) [RPC2440](#) [RPC4815](#) [RPC4825](#) [RPC4840](#)