

# SLD8S Series

## Surface Mount



### Agency Approvals

Agency	Agency File Number
	E230531

### Maximum Ratings and Thermal Characteristics

( $T_A = 25^\circ\text{C}$  unless otherwise noted)

Parameter	Symbol	Value	Unit
Peak Pulse Power Dissipation 1. 10ms x 150ms test waveform	$P_{PPM}$	2200	W
2. 10/1000 test waveform		7000	W
Power dissipation on infinite heatsink at $T_C = 25^\circ\text{C}$	$P_D$	8.0	W
Maximum Instantaneous Forward Voltage at 100A for Unidirectional only	$V_F$	1.8	V
Peak forward surge current 8.3ms single half sine-wave	$I_{FSM}$	1000	A
Operating Junction and Storage Temperature Range	$T_J, T_{STG}$	-55 to 175	$^\circ\text{C}$
Typical Thermal Resistance Junction to case	$R_{\theta JC}$	0.9	$^\circ\text{C/W}$

### Functional Diagram

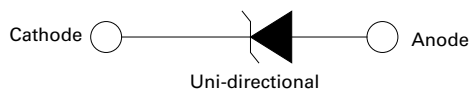

## Description

The SLD8S Series TVS Diode is housed in a SMT0-263 package with lead modifications. It is designed to protect sensitive electronics against lightning and inductive load switching voltage transient events for severe Automotive Load Dump applications.

## Features & Benefits

- AEC-Q101 qualified
- SMT0-263 package, and foot print is compatible to industrial popular DO-218AB package
- Meet ISO7637-2 5a/5b protection and ISO16750 load dump test (refer to APP note for details)
- $V_{BR} @ T_J = V_{BR} @ 25^\circ\text{C} \times (1 + \alpha T \times (T_J - 25))$  ( $\alpha$ : Temperature Coefficient, typical value is 0.1%)
- Glass passivated chip junction in modified TO-263 package
- ESD protection of data lines in accordance with IEC 61000-4-2, 30kV(Air), 30kV(Contact)
- EFT protection of data lines in accordance with IEC 61000-4-4
- Fast response time: typically less than 1.0ps from 0 Volts to BV min
- Excellent clamping capability
- Low incremental surge resistance
- UL Recognized compound meeting flammability rating V-0
- Meets MSL level 1, per J-STD-020, LF maximum peak of 260 $^\circ\text{C}$
- For surface mounted applications to optimize board space
- Low profile package
- High temperature to reflow soldering guaranteed: 260 $^\circ\text{C}$ /10sec at terminals
- Matte tin lead-free plated
- Halogen free and RoHS compliant
- Pb-free E3 means 2nd level interconnect is Pb-free and the terminal finish material is tin (Sn) (IPC/JEDEC J-STD-609A.01)

## Applications

Designed to protect sensitive electronics from:

- Inductive Load Switching
- Alternator Load Dump

# SLD8S Series

## Surface Mount

### Electrical Characteristics ( $T_A=25^\circ\text{C}$ unless otherwise noted)

Part Number (Uni)	Breakdown Voltage $V_{BR}$ @ $I_T$ (V)		Test Current $I_T$ (mA)	Reverse Stand off Voltage $V_R$ (Volts)	Maximum Reverse Leakage $I_R$ @ $V_R$ ( $\mu\text{A}$ )	$T_J=150^\circ\text{C}$ Max. Reverse Leakage $I_R$ @ $V_R$ ( $\mu\text{A}$ )	Maximum Peak Pulse Surge Current $I_{PP}$ (A)	Maximum Clamping Voltage $V_C$ @ $I_{PP}$ (V)	Agency Approval 
	MIN	MAX							
SLD8S14A	15.6	17.2	5.0	14	10	50	301	23.2	X
SLD8S15A	16.7	18.5	5.0	15	10	50	286	24.4	X
SLD8S16A	17.8	19.7	5.0	16	2.0	50	269	26.0	X
SLD8S17A	18.9	20.9	5.0	17	2.0	50	253	27.6	X
SLD8S18A	20.0	22.1	5.0	18	2.0	50	240	29.2	X
SLD8S20A	22.2	24.5	5.0	20	2.0	50	216	32.4	X
SLD8S22A	24.4	26.9	5.0	22	2.0	50	197	35.5	X
SLD8S24A	26.7	29.5	5.0	24	2.0	50	180	38.9	X
SLD8S26A	28.9	31.9	5.0	26	2.0	50	167	42.1	X
SLD8S27A	29.9	33.1	5.0	27	2.0	50	160	43.6	X
SLD8S28A	31.1	34.4	5.0	28	2.0	50	154	45.4	X
SLD8S30A	33.3	36.8	5.0	30	2.0	50	144	48.4	X
SLD8S33A	36.7	40.6	5.0	33	2.0	50	132	53.3	X
SLD8S36A	40.0	44.2	5.0	36	2.0	50	121	58.1	X
SLD8S40A	44.4	49.1	5.0	40	2.0	50	108	64.5	X
SLD8S43A	47.8	52.8	5.0	43	2.0	50	101	69.4	X
SLD8S48A	53.3	58.9	5.0	48	2.0	50	89.7	77.4	X
SLD8S57A	63.8	69.9	5.0	57	2.0	50	75.5	92.7	X
SLD8S60A	66.7	73.7	5.0	60	2.0	50	72.3	96.8	
SLD8S64A	71.1	78.6	5.0	64	2.0	50	68.0	103.0	

#### Notes:

- $V_{BR}$  measured after  $I_T$  applied for 300 $\mu\text{s}$ ,  $I_T$ = square wave pulse or equivalent.
- Surge current waveform per 10/1000 exponential wave and derated per Fig. 2
- All terms and symbols are consistent with ANSI/IEEE C62.35.

### Load Dump Test Wave Form

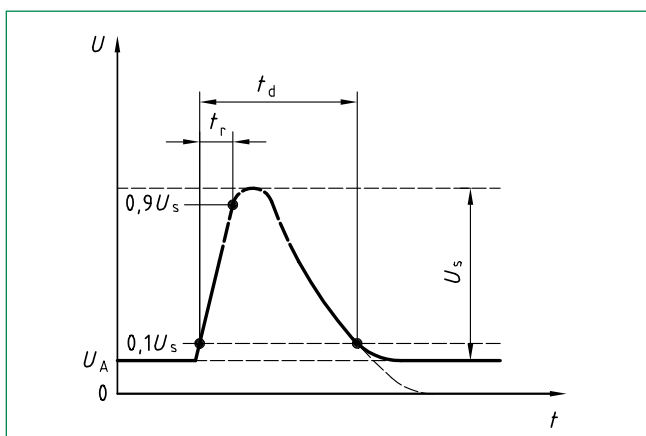

Note: LF use  $t_d=400\text{ms}$  for 12V system test;  $t_d=350\text{ms}$  for 24V system

Parameter	12V system	24V system
$U_s$	65v to 87V	123V to 174V
$R_l$	0.5 $\Omega$ to 4 $\Omega$	1 $\Omega$ to 8 $\Omega$
$t_d$	40 ms to 400 ms	100 ms to 350 ms
$t_r$	(10 <sup>-5</sup> )ms	

# SLD8S Series

## Surface Mount

### I-V Curve Characteristics

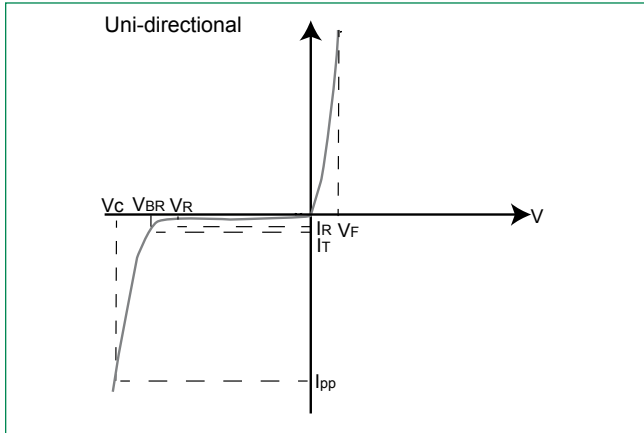

- $P_{PPM}$  Peak Pulse Power Dissipation** – Max power dissipation
- $V_R$  Stand-off Voltage** – Maximum voltage that can be applied to the TVS without operation
- $V_{BR}$  Breakdown Voltage** – Maximum voltage that flows through the TVS at a specified test current ( $I_T$ )
- $V_C$  Clamping Voltage** – Peak voltage measured across the TVS at a specified  $I_{ppm}$  (peak impulse current)
- $I_R$  Reverse Leakage Current** – Current measured at  $V_R$
- $V_F$  Forward Voltage Drop for Uni-directional**

### Ratings and Characteristic Curves ( $T_A=25^\circ\text{C}$ unless otherwise noted)

**Figure 1 - Peak Pulse Power Rating Curve**

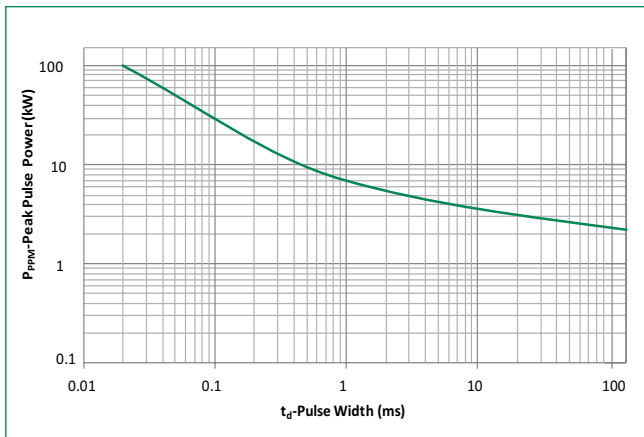

**Figure 2 - Peak Pulse Power Derating Curve**

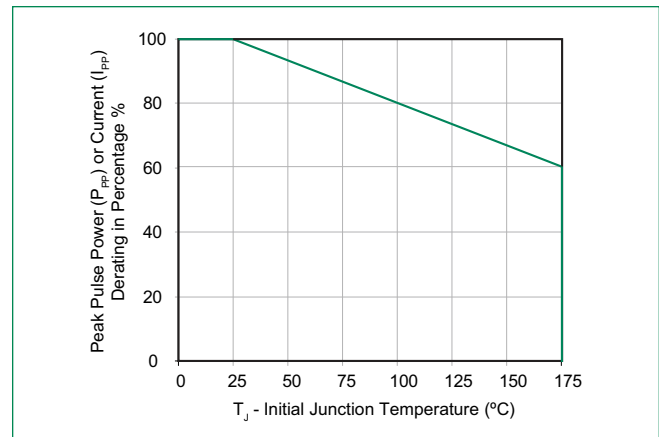

**Figure 3 - Typical Transient Thermal Impedance**

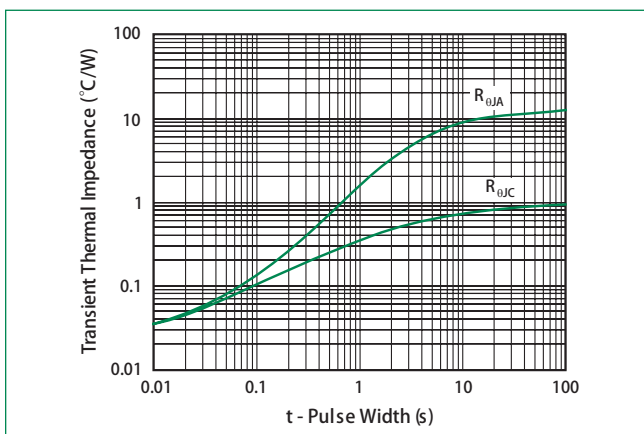

**Figure 4 - Typical Junction Capacitance**

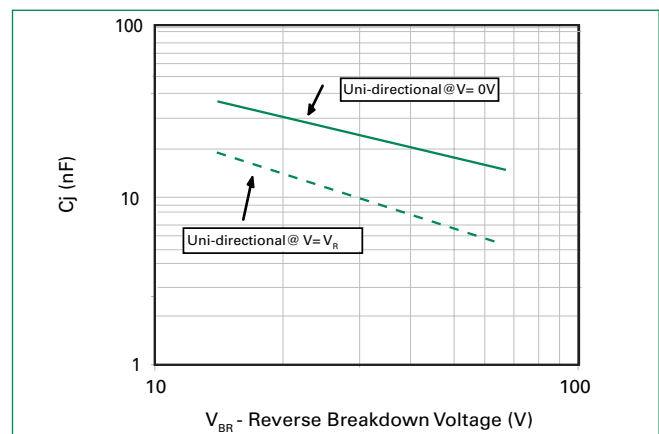

# SLD8S Series

## Surface Mount

**Figure 5 - Typical SOA Chart**

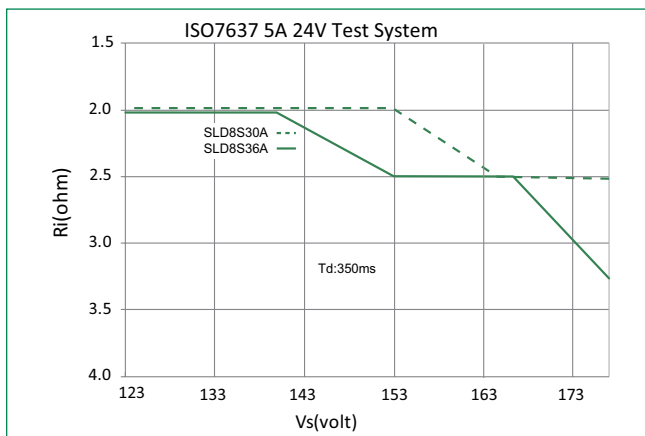
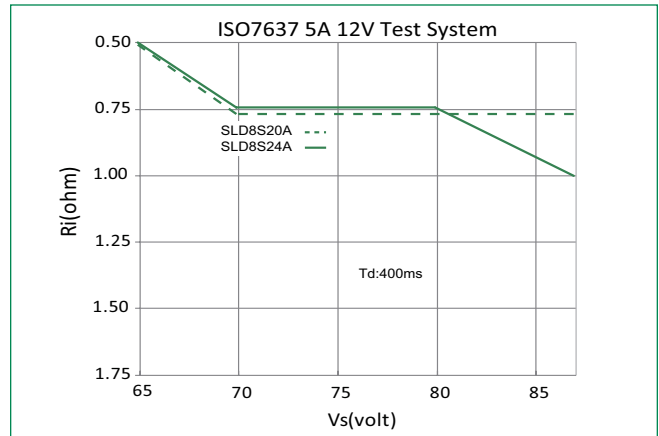
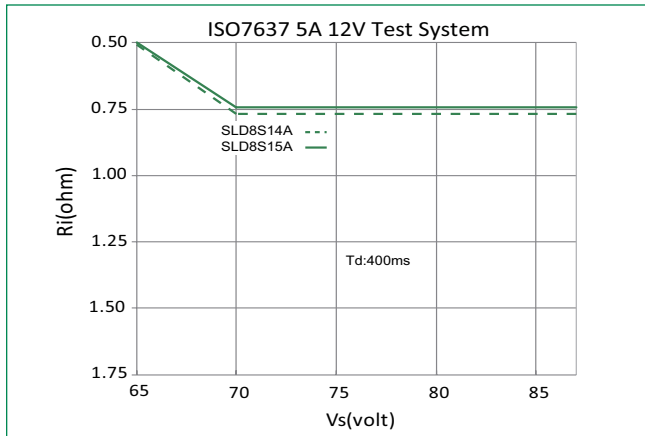

Note: SOA (Safe Operation Area) refer to the area which below the curve line and refer to APP note for details.

### Soldering Parameters

<b>Reflow Condition</b>		Pb – Free assembly
<b>Pre Heat</b>	- Temperature Min ( $T_{s(min)}$ )	150°C
	- Temperature Max ( $T_{s(max)}$ )	200°C
	- Time (min to max) ( $t_s$ )	60 – 180 secs
<b>Average ramp up rate (Liquidus Temp) (<math>T_L</math>) to peak</b>		5°C/second max
<b><math>T_{s(max)}</math> to <math>T_L</math> - Ramp-up Rate</b>		5°C/second max
<b>Reflow</b>	- Temperature ( $T_L$ ) (Liquidus)	217°C
	- Time (min to max) ( $T_s$ )	60 – 150 seconds
<b>Peak Temperature (<math>T_p</math>)</b>		260 <sup>+0/-5</sup> °C
<b>Time within 5°C of actual peak Temperature (<math>t_p</math>)</b>		20 – 40 seconds
<b>Ramp-down Rate</b>		5°C/second max
<b>Time 25°C to peak Temperature (<math>T_p</math>)</b>		8 minutes Max.
<b>Do not exceed</b>		260°C

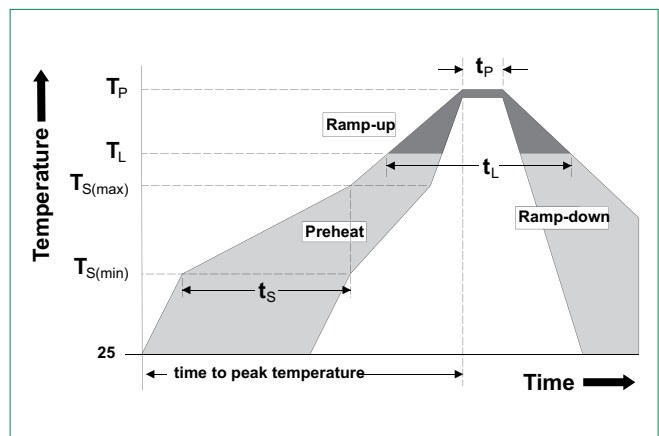

# SLD8S Series

## Surface Mount

### Physical Specifications

<b>Terminal Finish</b>	100% Matte Tin-plated
<b>Body Material</b>	UL Recognized compound meeting flammability rating V-0
<b>Lead Material</b>	Copper Alloy

### Environmental Specifications

<b>High Temp. Storage</b>	JESD22-A103
<b>HTRB</b>	JESD22-A108
<b>Temperature Cycling</b>	JESD22-A104
<b>MSL</b>	JEDEC-J-STD-020, LEVEL 1
<b>H3TRB</b>	JESD22-A101
<b>RSH</b>	JESD22-A111

### Dimensions

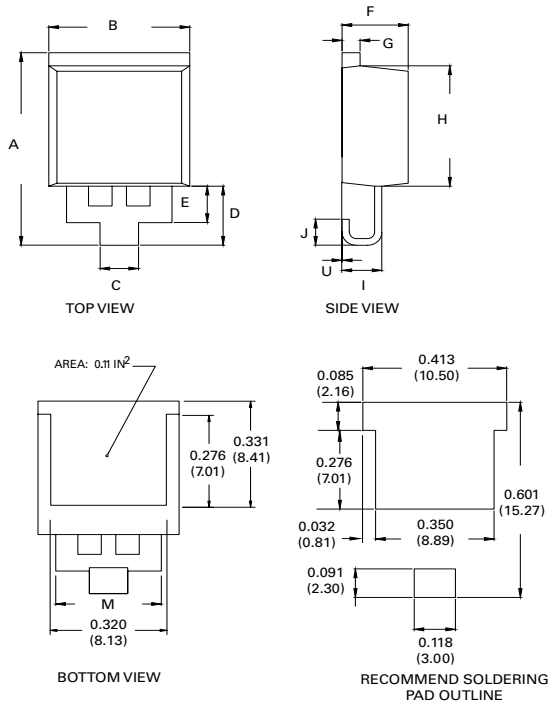

Dimensions	Inches		Millimeters	
	Min	Max	Min	Max
<b>A</b>	0.568	0.600	14.44	15.24
<b>B</b>	0.380	0.420	9.65	10.67
<b>C</b>	0.098	0.114	2.50	2.90
<b>D</b>	0.169	0.189	4.30	4.80
<b>E</b>	0.102	0.118	2.60	3.00
<b>F</b>	0.178	0.188	4.52	4.78
<b>G</b>	0.045	0.060	1.14	1.52
<b>H</b>	0.360	0.370	9.14	9.40
<b>I</b>	0.106	0.122	2.69	3.09
<b>J</b>	0.069	0.089	1.75	2.25
<b>M</b>	0.284	0.300	7.22	7.62
<b>U</b>	0	0.010	0	0.25

### Part Numbering System

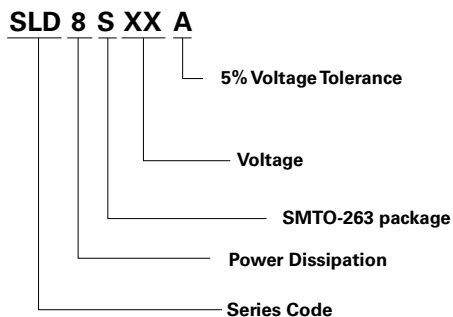

### Part Marking System

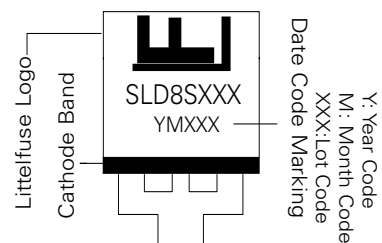

# SLD8S Series

## Surface Mount

### Packaging

Part Number	Component Package	Quantity	Packaging Option
SLD8SxxA	SMTO-263	500	Embossed Carrier

### SMTO-263 Embossed Carrier Reel Pack (RP) Specifications

Meets all EIA-481-2 Standards

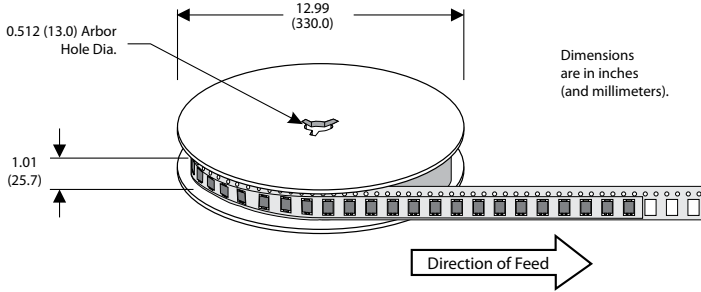
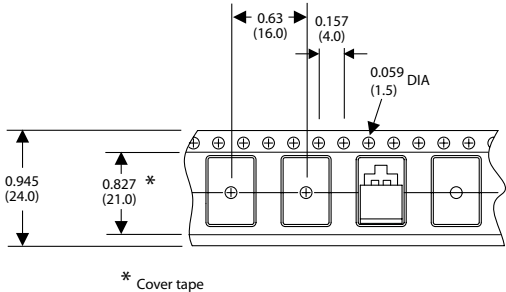

**Disclaimer Notice** - Information furnished is believed to be accurate and reliable. However, users should independently evaluate the suitability of and test each product selected for their own applications. Littelfuse products are not designed for, and may not be used in, all applications. Read complete Disclaimer Notice at <http://www.littelfuse.com/disclaimer-electronics>.

# Mouser Electronics

Authorized Distributor

Click to View Pricing, Inventory, Delivery & Lifecycle Information:

## Littelfuse:

[SLD8S22A](#) [SLD8S24A](#) [SLD8S13A](#) [SLD8S27A](#) [SLD8S40A](#) [SLD8S20A](#) [SLD8S18A](#) [SLD8S26A](#) [SLD8S17A](#)  
[SLD8S36A](#) [SLD8S43A](#) [SLD8S30A](#) [SLD8S48A](#) [SLD8S14A](#) [SLD8S33A](#) [SLD8S57A](#) [SLD8S28A](#) [SLD8S15A](#)  
[SLD8S12A](#) [SLD8S16A](#) [SLD8S45A](#) [SLD8S51A](#)