

FEATURES

- HIGH VOLTAGE 200Vdc ~ 5KVdc
- NPO AND X7R DIELECTRICS
- CASE SIZES FROM 0603 ~ 2225
- NICKEL BARRIER TERMINATION AND EXCELLENT MECHANICAL STRENGTH

RoHS Compliant

Includes all homogeneous materials

*See Part Number System for Details

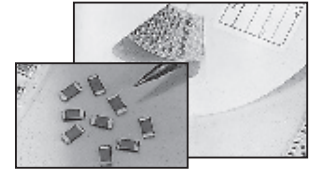

SPECIFICATIONS	NPO	X7R
Operating Temperature Range	-55°C ~ +125°C	-55°C ~ +125°C
Temperature Characteristic	±30ppm	±15%
Dissipation Factor	≤ 0.1%	≤ 2.5%
Insulation Resistance	≥ 500MegΩ or 500MegΩ-μF whichever is less Test Method: Voltage rating ≤ 500V measured after 1 minute at rated voltage, Voltage rating > 500V measured after 1 minute at 500V	
Capacitance Range	2.0pF ~ 0.039μF	150pF ~ 2.2μF
Capacitance Tolerance	±0.1pF(B), ±0.25pF(C), ±0.5pF(D) ±1%(F), ±2%(G), ±5%(J), ±10%(K), ±20(M)	±5%(J), ±10%(K), ±20(M)
Rated Voltage	200Vdc ~ 5KVdc	200Vdc ~ 3KVdc
Dielectric Withstanding Voltage	Working Voltage 200 & 250Vdc x 1.5 + 100Vdc for 5 seconds Working Voltage 500Vdc x 1.5 for 5 seconds Working Voltage greater than 500Vdc x 1.2 for 5 seconds	
Test Conditions (C & DF)	C ≤ 1000pF = 1MHz, 1Vrms @ 25°C C > 1000pF = 1KHz, 1Vrms @ 25°C	1KHz, 1Vrms @ 25°C

Note: Reflow soldering allowed for all case sizes. Contact NIC for wave soldering restrictions.

PART NUMBER SYSTEM

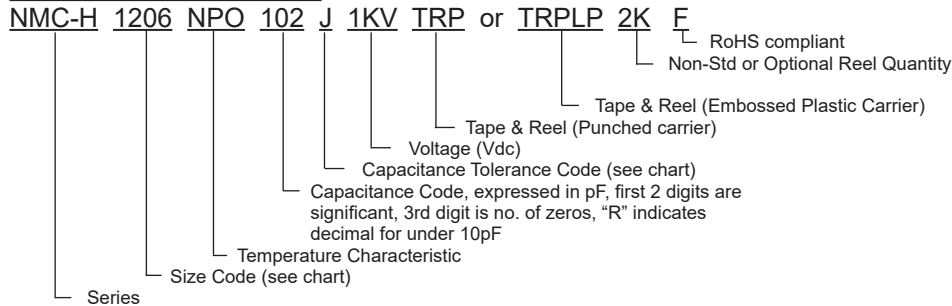

CONSTRUCTION

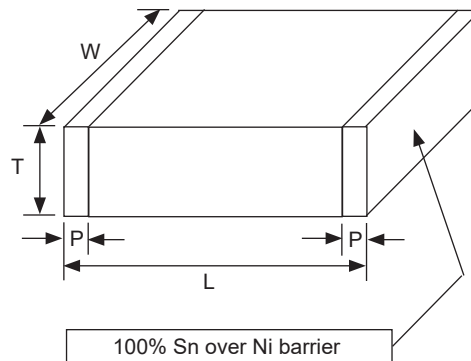

NPO-HIGH VOLTAGE SIZE CHART (mm)

EIA Case Size	0603		0805		1206				1210			
Length (L)	1.6 ± 0.10		2.0 ± 0.15		3.2 ± 0.15				3.2 ± 0.30			
Width (W)	0.80 ± 0.10		1.25 ± 0.10		1.6 ± 0.20				2.5 ± 0.20			
Thickness (T)	0.90 max.		1.45 max.		1.80 max.				2.60 max.			
Termination Width (P)	0.25 ~ 0.65		0.25 ~ 0.75		0.25 ~ 0.80				0.25 ~ 1.00			
Capacitance	Working Voltage (Vdc)											
	200	250	500	200	250	500	1K	2K	3K	200	250	500
2.0pF ~ 8.2pF												
10												
12												
15												
18												
22												
27												
33												
39												
47												
56												
68												
82												
100												
120												
150												
180												
220												
270												
330												
390												
470												
560												
680												
820												
0.001µF												
0.0012												
0.0015												
0.0018												
0.0022												
0.0027												
0.0033												
0.0039												
0.0047												
0.0068												
0.0082												



NPO-HIGH VOLTAGE SIZE CHART (mm)

EIA Case Size	1808			1812			1825			2220		2225	
Length (L)	4.6 ± 0.40			4.6 ± 0.30			4.6 ± 0.30			5.7 ± 0.40		5.70 ± 0.40	
Width (W)	2.0 ± 0.30			3.2 ± 0.30			6.35 ± 0.40			5.00 ± 0.40		6.35 ± 0.40	
Thickness (T)	2.20 max.			3.00 max.			3.00 max.			3.00 max.		3.00 max.	
Termination Width (P)	0.25 ~ 0.75			0.25 ~ 0.75			0.3 ~ 1.05			0.30 ~ 1.10		0.30 ~ 1.10	
Capacitance	Working Voltage (Vdc)												
	1K	2K	3K	1K	2K	3K	250	500	1K	5K	250	500	1K
2.0pF ~ 8.2pF													
10													
12													
15													
18													
22													
27													
33													
39													
47													
56													
68													
82													
100													
120													
150													
180													
220													
270													
330													
390													
470													
560													
680													
820													
0.001µF													
0.0012													
0.0015													
0.0018													
0.0022													
0.0027													
0.0033													
0.0039													
0.0047													
0.0056													
0.0068													
0.0082													
0.01µF													
0.012													
0.015													
0.018													
0.022													
0.027													
0.033													
0.039													



X7R-HIGH VOLTAGE SIZE CHART (mm)

EIA Case Size	0805				1206				1210					
Length (L)	2.0 ± 0.1				3.2 ± 0.15				3.2 ± 0.20					
Width (W)	1.25 ± 0.1				1.6 ± 0.15				2.5 ± 0.20					
Thickness (T)	1.45 max.				1.80 max.				2.20 max.					
Termination Width (P)	0.25 ~ 0.75				0.25 ~ 0.75				0.25 ~ 0.75					
Capacitance	Working Voltage (Vdc)													
	200	250	500	630	250	500	630	1K	2K	200	250	500	630	1K
150														
180														
220														
270														
330														
390														
470														
560														
680														
820														
0.001µF														
0.0012														
0.0015														
0.0018														
0.0022														
0.0027														
0.0033														
0.0039														
0.0047														
0.0056														
0.0068														
0.0082														
0.01µF														
0.012														
0.015														
0.018														
0.022														
0.027														
0.033														
0.039														
0.047														
0.056														
0.068														
0.082														
0.1µF														
0.12														
0.15														
0.18														
0.22														
0.27														
0.33														
0.47														



X7R-HIGH VOLTAGE SIZE CHART (mm)

EIA Case Size	1808				1812				1825				2220				2225			
Length (L)	4.6 ± 0.4				4.6 ± 0.4				4.6 ± 0.5				5.7 ± 0.40				5.70 ± 0.40			
Width (W)	2.0 ± 0.3				3.2 ± 0.3				6.3 ± 0.4				5.00 ± 0.40				6.35 ± 0.40			
Thickness (T)	2.20 max.				2.80 max.				2.20 max.				3.00 max.				3.00 max.			
Termination Width (P)	0.30 min.				0.30 min.				0.25 min.				0.30 ~ 1.10				0.30 ~ 1.10			
Capacitance	Working Voltage (Vdc)																			
	500	1K	2K	3K	200	250	500	1K	2K	3K	250	500	250	500	630	1K	2K	250	500	1K
150																				
180																				
220																				
270																				
330																				
390																				
470																				
560																				
680																				
820																				
0.001µF																				
0.0012																				
0.0015																				
0.0018																				
0.0022																				
0.0027																				
0.0033																				
0.0039																				
0.0047																				
0.0056																				
0.0068																				
0.0082																				
0.01µF																				
0.012																				
0.015																				
0.018																				
0.022																				
0.027																				
0.033																				
0.039																				
0.047																				
0.056																				
0.068																				
0.082																				
0.1µF																				
0.12																				
0.15																				
0.18																				
0.22																				
0.27																				
0.33																				
0.39																				
0.47																				
0.56																				
0.68																				
0.82																				
1.0µF																				
1.5																				
2.2																				



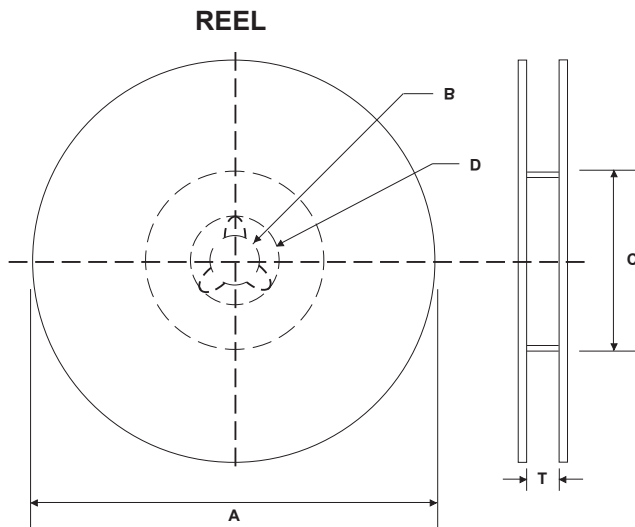

REEL DIMENSIONS (mm)

Reel Diameter (A)	B	C	D	T max.
7" (178 ± 2.0)	13 ± 0.5	50 min.	21 ± 1.0	8.4 +1.0/-0 (1812 case size 12.4 +2.0/-0)
10" (250 ± 2.0)		100 ± 1.0		
13" (330 ± 2.0)		100 ± 1.0		

7 INCH REEL QUANTITIES*

Size	01005	0201	0402	0603	0805	1206	1210	1808	1812
Tape Size	8mm	8mm	8mm	8mm	8mm	8mm	8mm	12mm	12mm
Min. Qty Per Reel	20,000	20,000	10,000	4,000	4,000	3,000	2,000	1,000	1,000
Max. Qty Per Reel	20,000	20,000	10,000	4,000	5,000	5,000	5,000	3,000	2,000

*Quantity dependent on chip thickness. Contact NIC for reel quantities on larger diameter reels.

CARRIER TAPE MATERIAL

Parts with a thickness of $\geq 1\text{mm}$ will be taped on embossed plastic carrier. Parts with a thickness of less than 1mm will be taped on paper carrier

EMBOSSED PLASTIC CARRIER TAPE DIMENSIONS (mm)

Tape Size	W	F	E	P ₀	P ₂	D	K max.	T max.	P
8mm	8.0 ± 0.2	3.5 ± 0.05	1.75 ± 0.10	4.0 ± 0.1	2.0 ± 0.5	1.5 ^{+0.1} _{-0.0}	3.0	2.0	4.0 ± 0.1
12mm	12 ± 0.2	5.5 ± 0.05						4.5	8.0 ± 0.1

Notes:

- Specifications are in compliance with EIA RS481-1-A "Taping of surface Mount Components for Automatic Placement"
- Dimensions A₀ (max.) equals component width dimension plus 0.5mm
- Dimension B₀ (max.) equals component length dimension plus 0.5mm

EMBOSSED PLASTIC CARRIER TAPE

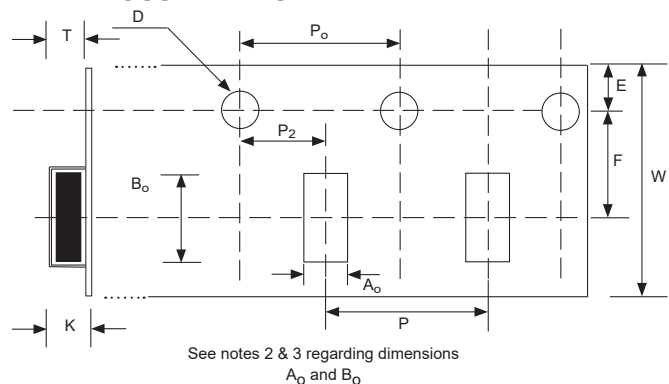

PUNCHED CARRIER TAPE DIMENSIONS (mm)

Type	A ₀	B ₀	W	F	E	P1	P0	D0	T1 max.	T2 max.	Mounting Hole
01005	0.25 ± 0.04	0.45 ± 0.04	8.0 ± 0.3	3.5 ± 0.05	1.75 ± 0.1	2.0 ± 0.05	4.0 ± 0.1	1.5 ^{+0.1} _{-0.0}	0.27	0.36	Angular Punch Hole
0201	0.37 ± 0.03	0.67 ± 0.05				4.0 ± 0.10			0.45	0.80	
0402	0.65 ± 0.05	1.15 ± 0.05									
0603	1.1 ± 0.2	1.9 ± 0.2									
0805	1.65 ± 0.2	2.4 ± 0.2									
1206	2.0 ± 0.2	3.6 ± 0.2									

PUNCHED CARRIER TAPE

