

CMOS linear image sensor

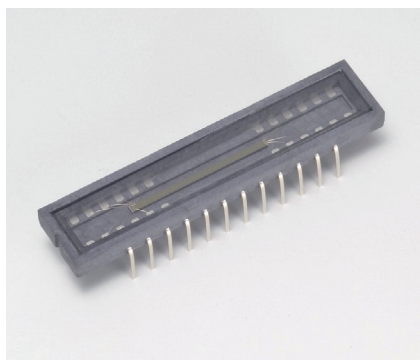

S10077

Digital output, built-in 8/10-bit A/D converter, single power supply operation

The S10077 is a CMOS linear image sensor designed for image input applications. The signal processing circuit has a charge amplifier with excellent input/output characteristics. The circuit also includes a 8-bit/10-bit A/D converter.

Features

- Pixel pitch: 14 μm
Pixel height: 50 μm
- 1024 pixels
- Single power supply operation: 3.3 to 5 V
- On-chip charge amplifier with excellent input/output characteristics
- Built-in timing generator allows operation with only start and clock pulse inputs.
- Video data rate: 1 MHz max.
- Spectral response range: 400 to 1000 nm
- Digital output
- 8-bit/10-bit switchable ADC
- Simultaneous all-pixel integration and variable integration time function
- Low power consumption

Applications

- Analytical instruments
- Position detection
- Image reading

Structure

Parameter	Specification	Unit
Number of pixels	1024	-
Pixel pitch	14	μm
Pixel height	50	μm
Photosensitive area length	14.336	mm
Package	LCP (liquid crystal polymer)	-
Window material	Borosilicate glass	-

Absolute maximum ratings

Parameter	Symbol	Condition	Value	Unit
Supply voltage	Vdd	Ta=25 °C	-0.3 to +6	V
A/D mode selection voltage	Vsel	Ta=25 °C	-0.3 to +6	V
Clock pulse voltage	V(CLK)	Ta=25 °C	-0.3 to +6	V
Start pulse voltage	V(ST)	Ta=25 °C	-0.3 to +6	V
Operating temperature*1	Topr		-5 to +50	°C
Storage temperature*1	Tstg		-10 to +60	°C

*1: No condensation

Note: Exceeding the absolute maximum ratings even momentarily may cause a drop in product quality. Always be sure to use the product within the absolute maximum ratings.

▣ Recommended terminal voltage

Parameter		Symbol	Min.	Typ.	Max.	Unit
Supply voltage		Vdd	3.3	5	5.25	V
AD mode selection voltage	8-bit	Vsel	0	-	0.4	V
	10-bit		Vdd - 0.25	Vdd	Vdd + 0.25	V
Clock pulse voltage	High level	V(CLK)	Vdd - 0.25	Vdd	Vdd + 0.25	V
	Low level		0	-	0.4	V
Start pulse voltage	High level	V(ST)	Vdd - 0.25	Vdd	Vdd + 0.25	V
	Low level		0	-	0.4	V

▣ Electrical characteristics (Ta=25 °C)

Parameter		Symbol	Min.	Typ.	Max.	Unit
Clock pulse frequency	8-bit	f(CLK)	1 M	-	12 M	Hz
	10-bit		1 M	-	6 M	
Data rate		DR	-	f(CLK)/12	-	Hz
Digital output rise time (10 to 90%)	CL=10 pF*2	tr	-	-	30	ns
	CL=30 pF*2		-	-	60	
Digital output fall time (90 to 10%)	CL=10 pF*2	tf	-	-	30	ns
	CL=30 pF*2		-	-	60	
Current consumption	Vdd=3.3 V	Ic	8-bit*3	12	-	mA
			10-bit*4	10	-	
	Vdd=5 V		8-bit*3	16	-	
			10-bit*4	14	-	

*2: CL=Load capacitance of digital output terminal

*3: f(CLK)=12 MHz

*4: f(CLK)=6 MHz

▣ Electrical and optical characteristics (Ta=25 °C)

Parameter		Symbol	Min.	Typ.	Max.	Unit	
Spectral response range		λ	400 to 1000			nm	
Peak sensitivity wavelength		λ_p	-	700	-	nm	
Photosensitivity*5		R	-	30	-	V/lx · s	
Dark output*6	Vdd=3.3 V	8-bit*7	-	0.04	0.6	digit	
		10-bit*8	-	0.16	2.4		
	Vdd=5 V	8-bit*7	-	0.03	0.6		
		10-bit*8	-	0.12	2.4		
Saturation output*9	Vdd=3.3 V	Dsat	8-bit*7	255	-	digit	
			10-bit*8	1023	-		
	Vdd=5 V		8-bit*7	255	-		
			10-bit*8	1023	-		
Readout noise	Vdd=3.3 V	Nread	8-bit*7	0.7	2	digit	
			10-bit*8	-	2.8		8
	Vdd=5 V		8-bit*7	-	0.7		2
			10-bit*8	-	2.8		8
Offset output	Vdd=3.3 V	Doffset	8-bit*7	11	29	digit	
			10-bit*8	44	116		164
	Vdd=5 V		8-bit*7	7	19		27
			10-bit*8	28	76		108
Photoresponse nonuniformity*5 *10		PRNU	-	-	±10	%	

*5: Measured with a tungsten lamp of 2856 K

*6: Integration time Ts=10 s

*7: f(CLK)=12 MHz

*8: f(CLK)=6 MHz

*9: Absolute value with respect to 0 digit

*10: Photoresponse nonuniformity (PRNU) is the output nonuniformity that occurs when the entire photosensitive area is uniformly illuminated by light which is 50% of the saturation exposure level. PRNU is measured using 1022 pixels excluding the pixels at both ends, and is defined as follows:

$$PRNU = \Delta X / X \times 100 (\%)$$

X: average output of all pixels, ΔX : difference between X and maximum or minimum output

Spectral response (typical example)

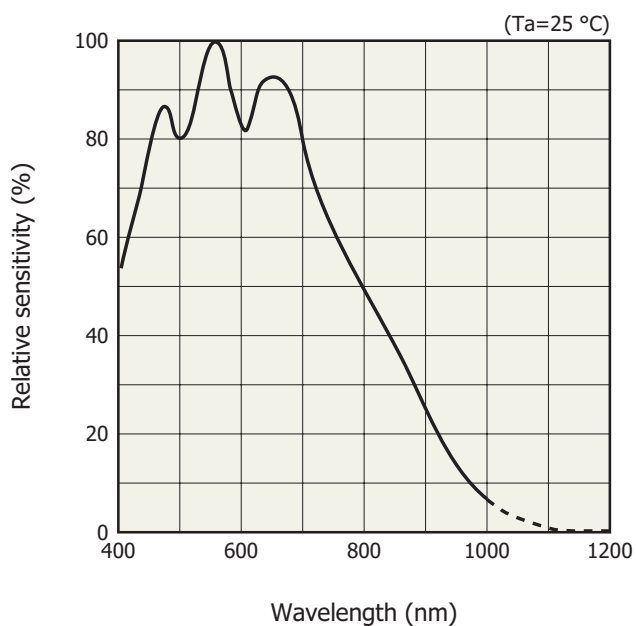

KMPDB0266EB

A/D converter specifications (Ta=25 °C)

Parameter	Symbol	Specification	Unit
Digital output format	-	Serial output	-
Resolution*11	RESO	8-bit mode	8
		10-bit mode	10
Conversion voltage range*12	-	Vdd=3.3 V	0 to 2.2
		Vdd=5 V	0 to 3.3

*11: Vsel=0 V (8-bit mode), Vdd (10-bit mode)

*12: Digital output is available from MSB as serial output.

8-bit mode: D7 to D0

10-bit mode: D9 to D0

Timing Chart

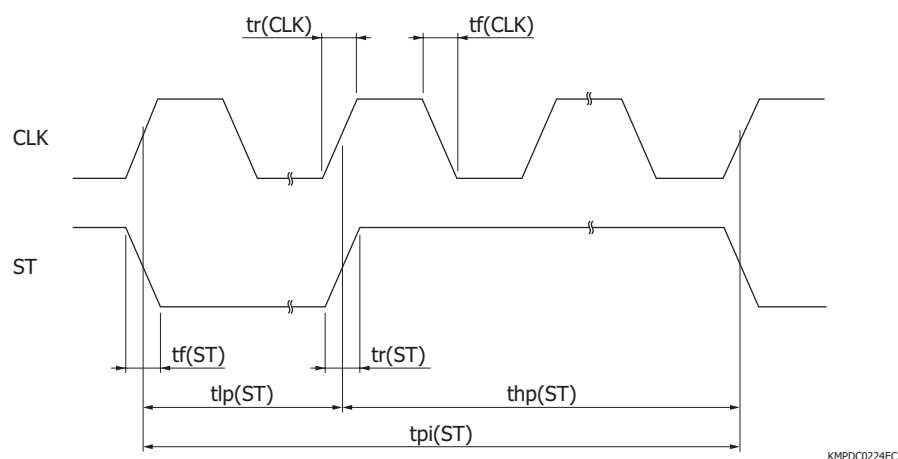

Parameter	Symbol	Min.	Typ.	Max.	Unit
Start pulse interval	tpi(ST)	12339/f(CLK)	-	120000/f(CLK)	s
Start pulse low period	tlp(ST)	45/f(CLK)	-	-	s
Start pulse high period*13	thp(ST)	6000/f(CLK)	-	-	s
Start pulse rise and fall times	tr(ST), tf(ST)	0	20	30	ns
Clock pulse duty	-	40	50	60	%
Clock pulse rise and fall times	tr(CLK), tf(CLK)	0	20	30	ns

*13: Signal charge integration time equals the high period of start pulse + 7 CLK cycles.
 The shift register operation starts at the fall of CLK pulse immediately after ST pulse sets to low.
 Integration time can be changed by changing the high-to-low ratio of ST pulses.

8-bit mode

■ In the neighborhood of start pixel

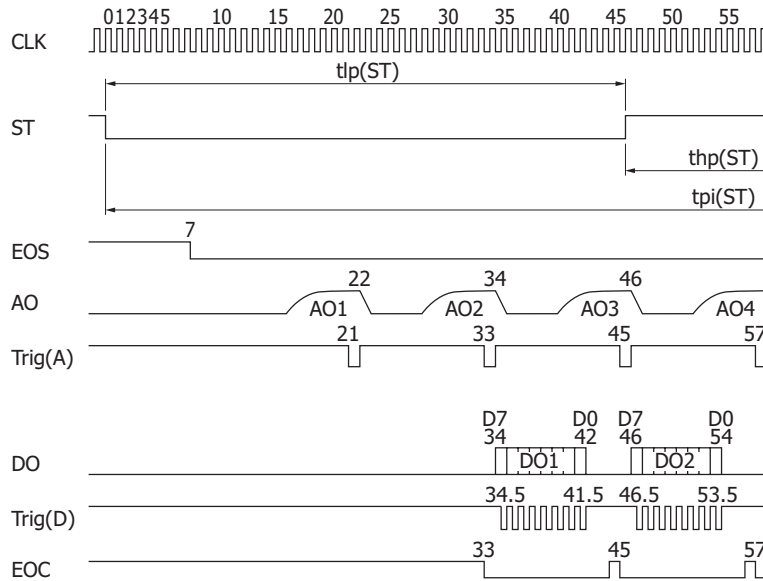

■ In the neighborhood of last pixel

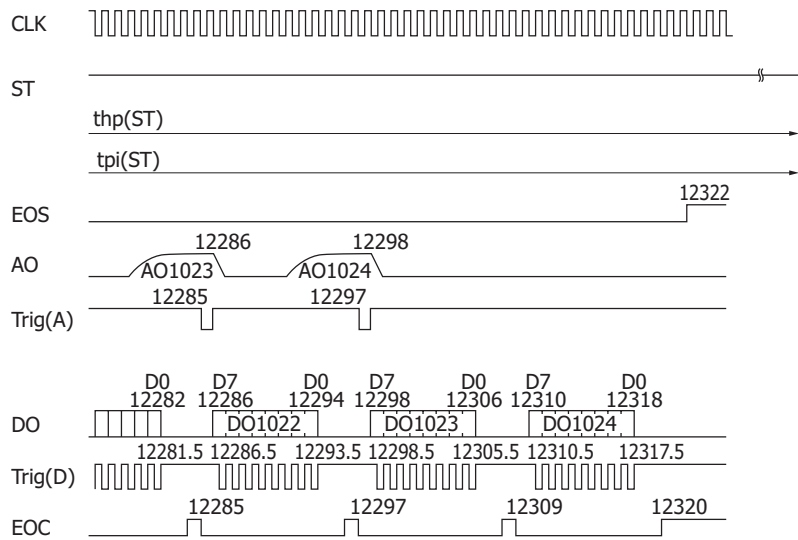

KMPDC0225EB

Note: When using analog output AO, read the AO output at the falling edge of Trig(A).
When using digital output DO, read the DO output at the falling edge of Trig(D).

10-bit mode

■ In the neighborhood of start pixel

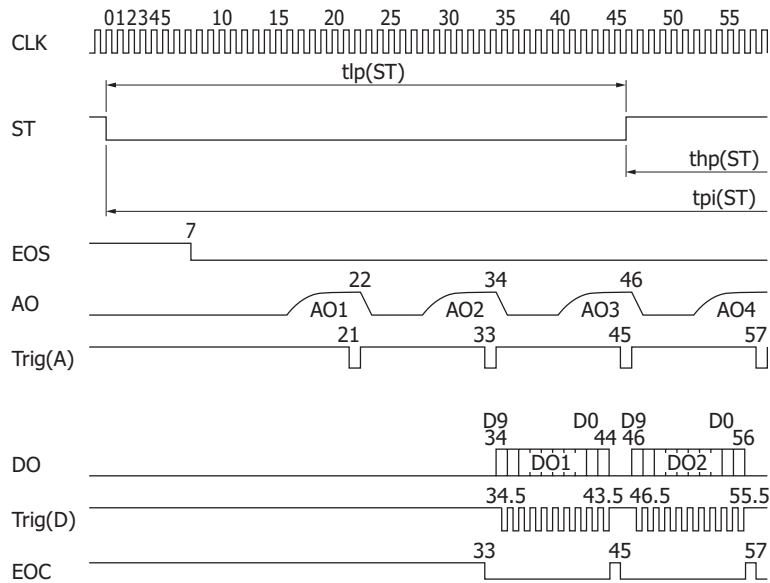

■ In the neighborhood of last pixel

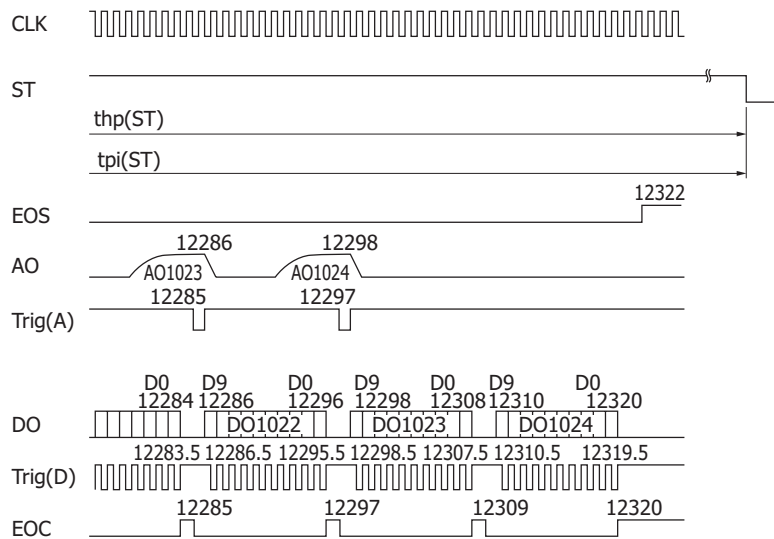

KMPDC0226EB

Note: When using analog output AO, read the AO output at the falling edge of Trig(A).
 When using digital output DO, read the DO output at the falling edge of Trig(D).

Dimensional outline (unit: mm)

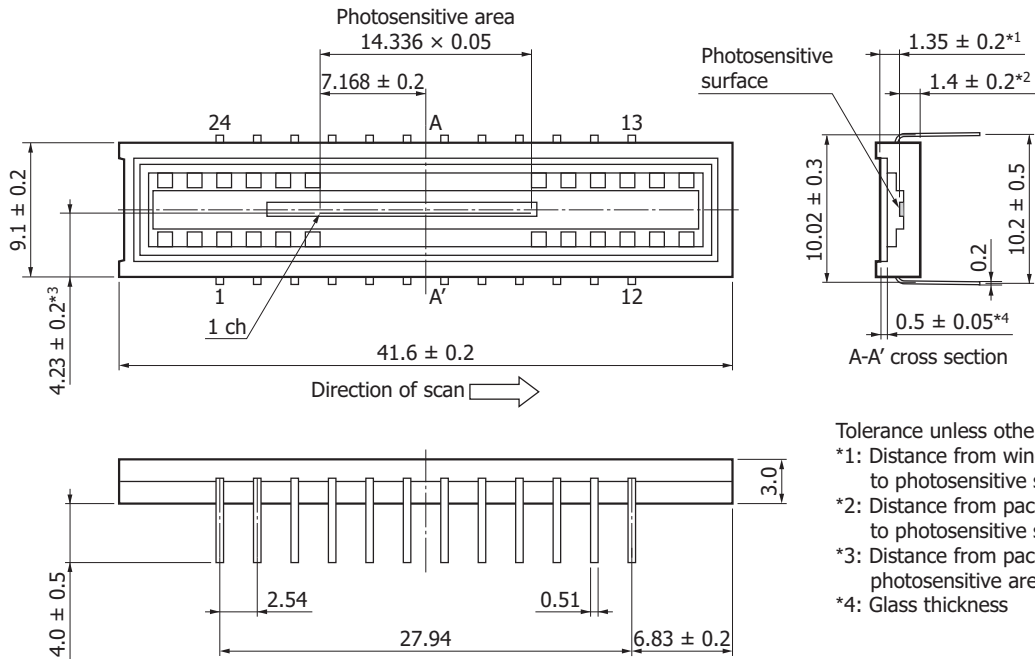

Tolerance unless otherwise noted: ± 0.1
 *1: Distance from window upper surface to photosensitive surface
 *2: Distance from package bottom to photosensitive surface
 *3: Distance from package edge to photosensitive area center
 *4: Glass thickness

KMPDA0202EF

Pin connections

Pin no.	Symbol	I/O	Discription	Pin no.	Symbol	I/O	Discription
1	NC		No connection	13	NC		No connection
2	D.Trig	O	Trigger signal for digital output	14	NC		No connection
3	DO	O	Digital output	15	NC		No connection
4	A.Trig	O	Trigger signal for analog output	16	EOS	O	End of scan signal
5	AO	O	Analog output	17	EOC	O	Digital conversion end signal
6	NC		No connection	18	NC		No connection
7	NC		No connection	19	Vsel	I	A/D mode selection voltage
8	Vdd	I	Supply voltage	20	Vss	I	GND
9	Vss	I	GND	21	Vdd	I	Supply voltage
10	NC		No connection	22	CLK	I	Clock signal
11	NC		No connection	23	ST	I	Start signal
12	NC		No connection	24	NC		No connection

Note: Leave the "NC" terminals open and do not connect them to GND.

When using the analog output terminal, connect a buffer amplifier for impedance conversion to it so as to minimize the current flow. As the buffer amplifier, use a high input impedance operational amplifier with JFET or CMOS input.

⚠ Precautions

(1) Electrostatic countermeasures

This device has a built-in protection circuit against static electrical charges. However, to prevent destroying the device with electrostatic charges, take countermeasures such as grounding yourself, the workbench and tools to prevent static discharges. Also protect this device from surge voltages which might be caused by peripheral equipment.

(2) Incident window

If dust or dirt gets on the light incident window, it will show up as black blemishes on the image. When cleaning, avoid rubbing the window surface with dry cloth or dry cotton swab, since doing so may generate static electricity. Use soft cloth, paper or a cotton swab moistened with alcohol to wipe dust and dirt off the window surface. Then blow compressed air onto the window surface so that no spot or stain remains.

(3) Soldering

To prevent damaging the device during soldering, take precautions to prevent excessive soldering temperatures and times. Soldering should be performed within 5 seconds at a soldering temperature below 260 °C.

⚠ Related information

www.hamamatsu.com/sp/ssd/doc_en.html

■ Precautions

- Disclaimer
- Image sensors/Precautions

Information described in this material is current as of May 2019.

Product specifications are subject to change without prior notice due to improvements or other reasons. This document has been carefully prepared and the information contained is believed to be accurate. In rare cases, however, there may be inaccuracies such as text errors. Before using these products, always contact us for the delivery specification sheet to check the latest specifications.

The product warranty is valid for one year after delivery and is limited to product repair or replacement for defects discovered and reported to us within that one year period. However, even if within the warranty period we accept absolutely no liability for any loss caused by natural disasters or improper product use. Copying or reprinting the contents described in this material in whole or in part is prohibited without our prior permission.

HAMAMATSU

www.hamamatsu.com

HAMAMATSU PHOTONICS K.K., Solid State Division

1126-1 Ichino-cho, Higashi-ku, Hamamatsu City, 435-8558 Japan, Telephone: (81)53-434-3311, Fax: (81)53-434-5184

U.S.A.: Hamamatsu Corporation: 360 Foothill Road, Bridgewater, N.J. 08807, U.S.A., Telephone: (1)908-231-0960, Fax: (1)908-231-1218, E-mail: usa@hamamatsu.com

Germany: Hamamatsu Photonics Deutschland GmbH: Arzbergerstr. 10, D-82211 Herrsching am Ammersee, Germany, Telephone: (49)8152-375-0, Fax: (49)8152-265-8, E-mail: info@hamamatsu.de

France: Hamamatsu Photonics France S.A.R.L.: 19, Rue du Saule Trapu, Parc du Moulin de Massy, 91882 Massy Cedex, France, Telephone: (33)1 69 53 71 00, Fax: (33)1 69 53 71 10, E-mail: infos@hamamatsu.fr

United Kingdom: Hamamatsu Photonics UK Limited: 2 Howard Court, 10 Tewin Road, Welwyn Garden City, Hertfordshire AL7 1BW, United Kingdom, Telephone: (44)1707-294888, Fax: (44)1707-325777, E-mail: info@hamamatsu.co.uk

North Europe: Hamamatsu Photonics Norden AB: Torshamsgatan 35 16440 Kista, Sweden, Telephone: (46)8-509 031 00, Fax: (46)8-509 031 01, E-mail: info@hamamatsu.se

Italy: Hamamatsu Photonics Italia S.r.l.: Strada della Moia, 1 int. 6, 20020 Arese (Milano), Italy, Telephone: (39)02-93 58 17 33, Fax: (39)02-93 58 17 41, E-mail: info@hamamatsu.it

China: Hamamatsu Photonics (China) Co., Ltd.: B1201, Jiaming Center, No.27 Dongsanhuan Beilu, Chaoyang District, 100020 Beijing, P.R.China, Telephone: (86)10-6586-6006, Fax: (86)10-6586-2866, E-mail: hpc@hamamatsu.com.cn

Taiwan: Hamamatsu Photonics Taiwan Co., Ltd.: 8F-3, No. 158, Section2, Gongdao 5th Road, East District, Hsinchu, 300, Taiwan R.O.C. Telephone: (886)3-659-0080, Fax: (886)3-659-0081, E-mail: info@hamamatsu.com.tw