

General Specifications

Electrical Capacity (Resistive Load)

Power Level (silver): 5A @ 125/250V AC or 5A @ 30V DC
Logic Level (gold): 0.4VA maximum @ 28V AC/DC maximum
 (Applicable Range 0.1mA ~ 0.1A @ 20mV ~ 28V)
 Note: Find additional explanation of operating range in Supplement section.

Other Ratings

Contact Resistance: 50 milliohms maximum for silver; 100 milliohms maximum for gold
Insulation Resistance: 200 megohms minimum @ 500V DC
Dielectric Strength: 1,000V AC minimum between contacts for 1 minute minimum;
 1,500V AC minimum between contacts & case for 1 minute minimum

Mechanical Life: 1,000,000 operations minimum for momentary;
 200,000 operations minimum for alternate action

Electrical Life: 10,000 operations minimum for silver;
 200,000 operations minimum for gold

Nominal Operating Force: Single Pole: 1.90N
 Double Pole: 2.55N

Contact Timing: Break before make
Travel: Pretravel .067" (1.7mm); Overtravel .024" (0.6mm); Total Travel .091" (2.3mm)

Materials & Finishes

Housing/Bezel: Glass fiber reinforced polyamide (UL94V-0)
Snap-in Frame: Stainless steel
Movable Contact: Phosphor bronze
Movable Contacts: Silver alloy or copper with gold plating
Stationary Contacts: Silver alloy or copper with gold plating
Switch Terminals: Phosphor bronze with silver or gold plating
Lamp Terminals: Brass with tin plating
Base: Glass fiber reinforced liquid crystal polymer (UL94V-0)

Environmental Data

Operating Temperature Range: -25°C through +50°C (-13°F through +122°F) for Illuminated
 -25°C through +70°C (-13°F through +158°F) for Nonilluminated
Humidity: 90 ~ 95% humidity for 240 hours @ 40°C (104°F)
Vibration: 10 ~ 55Hz with peak-to-peak amplitude of 1.5mm traversing the frequency range & returning in 1 minute; 3 right angled directions for 2 hours
Shock: 50G (490m/s²) acceleration (tested in 6 right angled directions, with 5 shocks in each direction)

Installation

Cap Installation Force: 15.0N maximum downward force on cap

Processing

Soldering: Wave Soldering (PC version): See Profile A in Supplement section.
 Manual Soldering: See Profile A in Supplement section.
Cleaning: These devices are not process sealed. Hand clean locally using alcohol based solution.

Standards & Certifications

Flammability Standards: UL94V-0 housing/bezel & base
UL: **File No. E44145 - Recognized only when ordered with marking on switch.**
 Add "/U" or "/CUL" before dash in part number to order UL recognized switch.
 UL recognized only when ordered switch body with cap assembled.
 All single & double pole models recognized at 5A @ 125/250V AC or 0.014A @ 28V DC.

Distinctive Characteristics

Wide selection of illumination effects is achieved with single and bicolor, 1- or 6-element LEDs in flat, beveled, or sculptured caps.

Alternating legends in choice of sculptured or flat caps, combined with super bright bicolor LED.

Combination of PCB mountability and short body allows use in compact applications.

Small behind panel dimension for snap-in mounting in tight spaces.

Snap-acting contact mechanism provides sensitive actuation with audible feedback; quick-make, quick-break characteristic limits arcing and prolongs electrical life.

Latchdown mechanism, independent of switching mechanism, gives outstanding stability and reliability plus visible and tactile indication of circuit status.

Terminals are epoxy sealed to lock out flux, solvents, and other contaminants.

Momentary and alternate action circuits available in the same space-saving body size.

Matching indicators available.

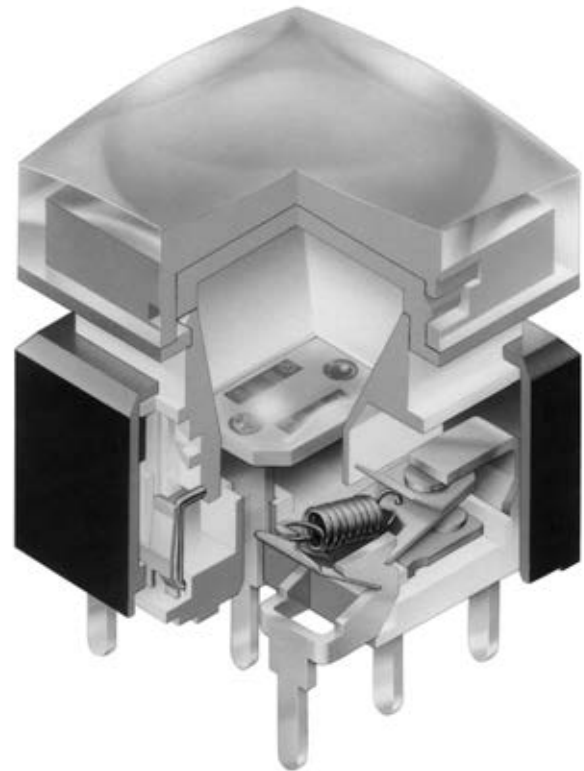

Actual Size

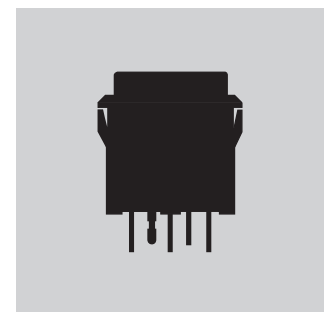

- Toggles
- Rockers
- Pushbuttons
- D Illuminated PB**
- Programmable
- Keylocks
- Rotaries
- Slides
- Tactiles
- Tilt
- Touch
- Indicators
- Accessories
- Supplement

TYPICAL SWITCH

UB2

1

5

SK

G

03

Poles

1	SPDT
2	DPDT

Circuits

5	ON	(ON)
() = Momentary		
6	ON	ON
Alternate Action with Latchdown		

Mounting Types

PCB Mounting

SK	Square
* Snap-in Mounting	
KK	Square
* Standard with Solder Lug terminals	

Terminals

01	Solder Lug (for Snap-in Mounting)
03	Straight PC

Contacts & Ratings

W	Silver Rated 5A @ 125/250V AC
G	Gold Rated 0.4VA max @ 28V AC/DC max

Part Numbers for Alternating Legends

Color	15mm Square Sculptured Cap	15mm Square Flat Cap
	Part Number	Part Number
Red/Green	AT3069JCF11 ~ AT3069JCF14	AT3070JCF11 ~ AT3070JCF14
Amber/Blue	AT3069JDG11 ~ AT3069JDG14	AT3070JDG11 ~ AT3070JDG14

Refer to Ordering Table for Alternating Legend that corresponds with last 2 digits of part number.

IMPORTANT:



Switches are supplied without UL & cULus marking unless specified. **UL & cULus recognized only when ordered with marking on switch.** Specific models, ratings, & ordering instructions are noted on the General Specifications page.

DESCRIPTION FOR TYPICAL ORDERING EXAMPLE

UB215SKG035C-1JC



Toggles
Rockers
Pushbuttons
Illuminated PB
Programmable
Keylocks
Rotaries
Slides
Tactiles
Tilt
Touch
Indicators
Accessories
Supplement

ORDERING EXAMPLE

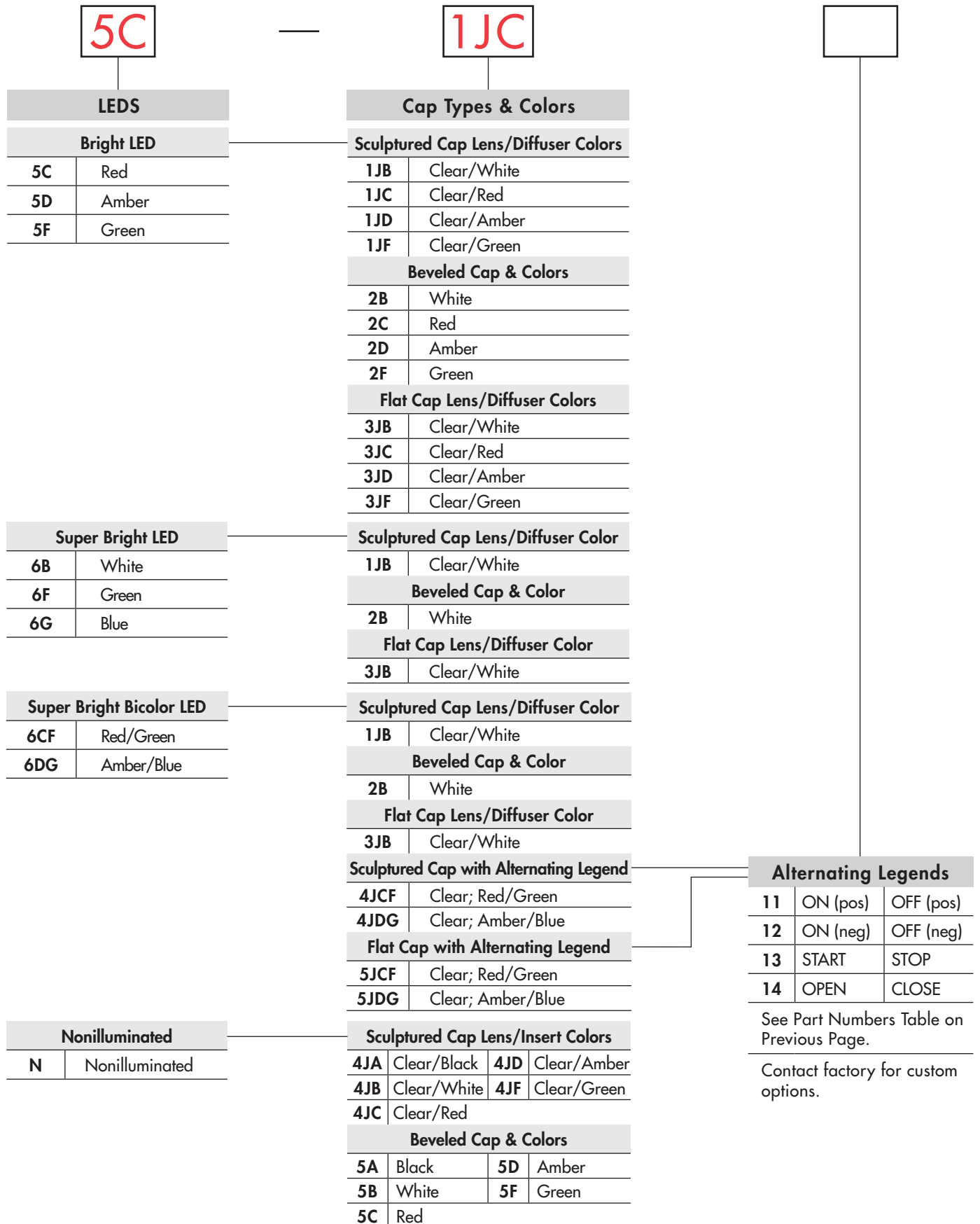

5C

LEDs	
Bright LED	
5C	Red
5D	Amber
5F	Green

Super Bright LED	
6B	White
6F	Green
6G	Blue

Super Bright Bicolor LED	
6CF	Red/Green
6DG	Amber/Blue

Nonilluminated	
N	Nonilluminated

1JC

Cap Types & Colors			
Sculptured Cap Lens/Diffuser Colors			
1JB	Clear/White		
1JC	Clear/Red		
1JD	Clear/Amber		
1JF	Clear/Green		
Beveled Cap & Colors			
2B	White		
2C	Red		
2D	Amber		
2F	Green		
Flat Cap Lens/Diffuser Colors			
3JB	Clear/White		
3JC	Clear/Red		
3JD	Clear/Amber		
3JF	Clear/Green		
Sculptured Cap Lens/Diffuser Color			
1JB	Clear/White		
Beveled Cap & Color			
2B	White		
Flat Cap Lens/Diffuser Color			
3JB	Clear/White		
Sculptured Cap Lens/Diffuser Color			
1JB	Clear/White		
Beveled Cap & Color			
2B	White		
Flat Cap Lens/Diffuser Color			
3JB	Clear/White		
Sculptured Cap with Alternating Legend			
4JCF	Clear; Red/Green		
4JDG	Clear; Amber/Blue		
Flat Cap with Alternating Legend			
5JCF	Clear; Red/Green		
5JDG	Clear; Amber/Blue		
Sculptured Cap Lens/Insert Colors			
4JA	Clear/Black	4JD	Clear/Amber
4JB	Clear/White	4JF	Clear/Green
4JC	Clear/Red		
Beveled Cap & Colors			
5A	Black	5D	Amber
5B	White	5F	Green
5C	Red		

Alternating Legends		
11	ON (pos)	OFF (pos)
12	ON (neg)	OFF (neg)
13	START	STOP
14	OPEN	CLOSE

See Part Numbers Table on Previous Page.

Contact factory for custom options.

POLES & CIRCUITS

Pole	Model	Plunger Position () = Momentary		Connected Terminals		Throw & Switch/Lamp Schematics
		Normal	Down	Normal	Down	
SP	UB215 *UB216	ON ON	(ON) ON	1-3	1-2	SPDT
DP	UB225 *UB226	ON ON	(ON) ON	1-3 4-6	1-2 4-5	DPDT

Notes: Switch is marked with NC, NO, COM, L+ & L-. Lamp circuit is isolated and requires an external power source.

* When in latchdown position for the alternate circuit, cap positions above the housing are: .059" (1.5mm) for snap-in models & .276" (7.0mm) for PCB models.

MOUNTING TYPES & SHAPES

PCB Mounting



Square

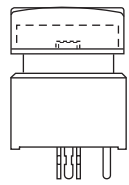

SP, Single Color LED

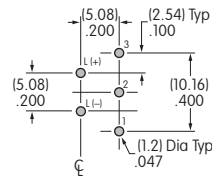

DP, Single Color LED

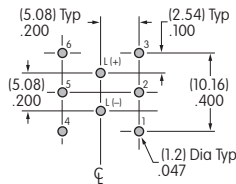

SP, Bicolor LED

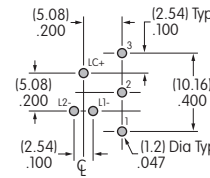

DP, Bicolor LED

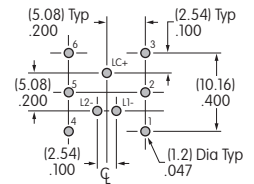

Snap-in Mounting (Solder Lug)



Square with Built-in Bezel

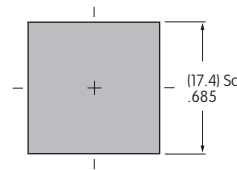
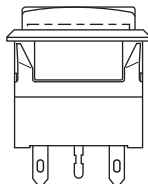

Panel Thickness:
.039 ~ .126"
(1.0 ~ 3.2mm)

CONTACT MATERIALS & RATINGS



Silver Contacts

Power Level

5A @ 125V AC & 250V AC



Gold Contacts

Logic Level

0.4VA maximum @ 28V AC/DC maximum

Complete explanation of operating range in Supplement section.

SWITCH & LAMP TERMINALS



Solder Lug

For Switch & Bright LED

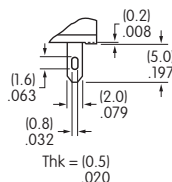

For Super Bright & Bicolor LED

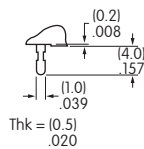

Straight PC

For Switch & Bright LED

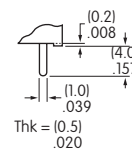

For Super Bright & Bicolor LED

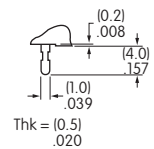

BRIGHT LED & CAPS

The electrical specifications shown are determined at a basic temperature of 25°C.
 LED circuit is isolated and requires an external power source. Polarity marks are on the bottom of the switch.
 If the source voltage exceeds the rated voltage, a ballast resistor is required.
 The resistor value can be calculated by using the formula in the Supplement section.

The LED is an integral part of the switch and not available separately.

Electrical Specifications for Bright LED

		5C	5D	5F	
	Color	Red	Amber	Green	Unit
Maximum Forward Current	I_{FM}	30	30	25	mA
Typical Forward Current	I_F	20	20	20	mA
Forward Voltage	V_F	1.85	2.0	2.1	V
Maximum Reverse Voltage	V_{RM}	5	5	5	V
Current Reduction Rate Above 25°C	ΔI_F	0.40	0.42	0.46	mA/°C
Ambient Temperature Range		-25° ~ +50°			°C

Bright Single Color LED with 1 element

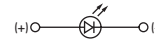

Caps for Bright LED

1 AT3074 Sculptured

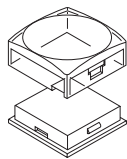
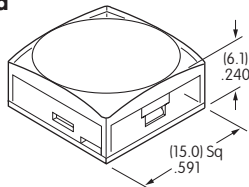

Clear Lens
 Translucent Colored Diffuser

2 AT3075 Beveled

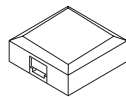
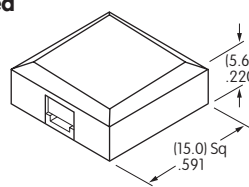

Translucent Colored Cap

3 AT3076 Flat

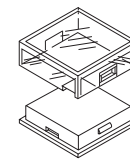
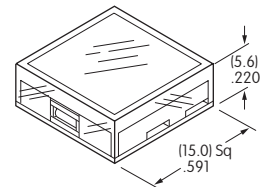

Clear Lens
 Translucent Colored Diffuser

Lens/Diffuser Colors Available:

- JB** Clear/White
- JC** Clear/Red
- JD** Clear/Amber
- JF** Clear/Green

Cap Colors Available:

- B** White
- C** Red
- D** Amber
- F** Green

Lens/Diffuser Colors Available:

- JB** Clear/White
- JC** Clear/Red
- JD** Clear/Amber
- JF** Clear/Green

Material: Polycarbonate

Finish: Glossy

SUPER BRIGHT LEDS & CAPS

The electrical specifications shown are determined at a basic temperature of 25°C. LED circuit is isolated and requires an external power source. Polarity marks are on the bottom of the switch. If the source voltage exceeds the rated voltage, a ballast resistor is required. The resistor value can be calculated by using the formula in the Supplement section. The LED is an integral part of the switch and not available separately.

Electrical Specifications for Super Bright LEDs

Super Bright LEDs are Electrostatic Sensitive		Color	6B White	6F Green	6G Blue	Unit
Maximum Forward Current		I_{FM}	20	30	30	mA
Typical Forward Current		I_F	15	20	20	mA
Forward Voltage		V_F	3.3	3.5	3.6	V
Maximum Reverse Voltage		V_{RM}	5	5	5	V
Current Reduction Rate Above 25°C		ΔI_F	0.25	0.50	0.50	mA/°C
Ambient Temperature Range			-20° ~ +50°			°C

Super Bright Single Color LED with 1 element



Caps for Super Bright LED

1JB

AT3074JB
Sculptured
Clear Lens/
White Diffuser

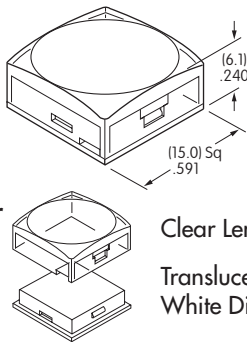

2B

AT3075B
Beveled
White Cap

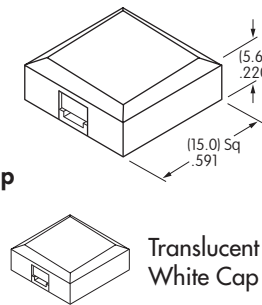

3JB

AT3076JB
Flat
Clear Lens/
White Diffuser

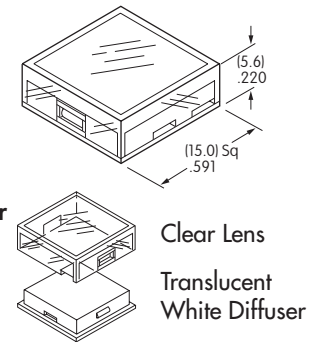

Material: Polycarbonate

Finish: Glossy

SUPER BRIGHT BICOLOR LEDS & CAPS

The electrical specifications shown are determined at a basic temperature of 25°C. LED circuit is isolated and requires an external power source. Polarity marks are on the bottom of the switch. If the source voltage exceeds the rated voltage, a ballast resistor is required. The resistor value can be calculated by using the formula in the Supplement section. The LED is an integral part of the switch and not available separately.

Electrical Specifications for Super Bright Bicolor LEDs

Super Bright LEDs are Electrostatic Sensitive		Color	6CF		6DG		Unit
			Red	Green	Amber	Blue	
Maximum Forward Current		I_{FM}	30 * 25 for Amber	25 * 22 for Amber	30	30	mA
Typical Forward Current		I_F	20	20	15	15	mA
Forward Voltage		V_F	2.1	3.5	2.0	2.8	V
Maximum Reverse Voltage		V_{RM}	4	4	4	4	V
Current Reduction Rate Above 25°C		ΔI_F	0.40	0.33	0.33	0.33	mA/°C
Ambient Temperature Range			-20° ~ +50°		-20° ~ +50°		°C

Super Bright Bicolor LED with 2 elements

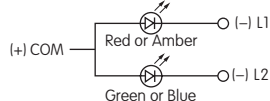

* Amber color is achieved by lighting red and green simultaneously, but is not suitable for Alternating Legends.

Caps for Super Bright Bicolor LED

1JB

AT3074JB Sculptured
Clear Lens/White Diffuser

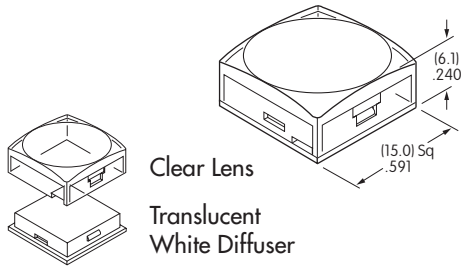

2B

AT3075B Beveled
White Cap

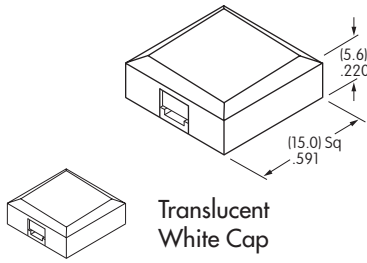

3JB

AT3076JB Flat
Clear Lens/White Diffuser

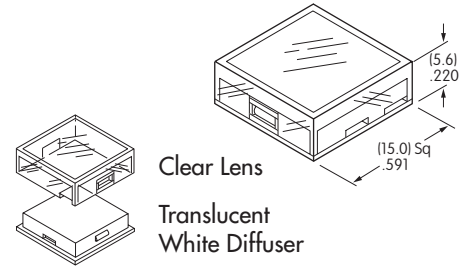

Material: Polycarbonate Finish: Glossy

Alternating Legend Caps for Super Bright Bicolor LED

AT3069J Sculptured Cap
with Alternating Legend

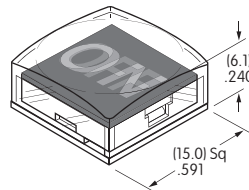

AT3070J Flat Cap with
Alternating Legend

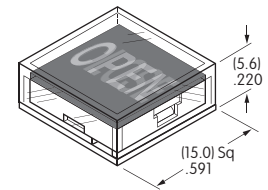

4JCF

Red/Green

5JCF

Red/Green

4JDG

Amber/Blue

5JDG

Amber/Blue

Clear Lens
Alternating Legend Filter

Clear Lens
Alternating Legend Filter

Material: Polycarbonate Finish: Glossy

Standard Alternating Legend Pairs

11

ON OFF

Green/Red or Blue/Amber

12

ON OFF

Green/Red or Blue/Amber

13

START STOP

Green/Red or Blue/Amber

14

OPEN CLOSE

Green/Red or Blue/Amber

Cap illumination is alternating Green/Red or Blue/Amber; legend text is black.
Contact factory for other Alternating Legends.

Legend illustrations are approximate representations of the actual characters on the filters.

No Code

No Lamp

CAP TYPES & COLOR COMBINATIONS FOR NONILLUMINATED

4

AT3073 Sculptured



5

AT3077 Beveled



Lens/Insert
Colors Available:

JA

Clear/Black

JB

Clear/White

JC

Clear/Red

JD

Clear/Amber

JF

Clear/Green

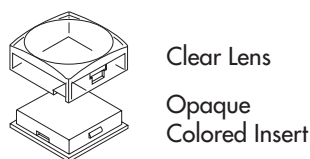

Clear Lens
Opaque
Colored Insert

Material: Polycarbonate
Finish: Glossy

Cap
Colors Available:

A

Black

B

White

C

Red

D

Amber

F

Green



Opaque
Colored Cap

Material: Polycarbonate
Finish: Glossy

TYPICAL SWITCH DIMENSIONS

Bright & Super Bright LED Straight PC

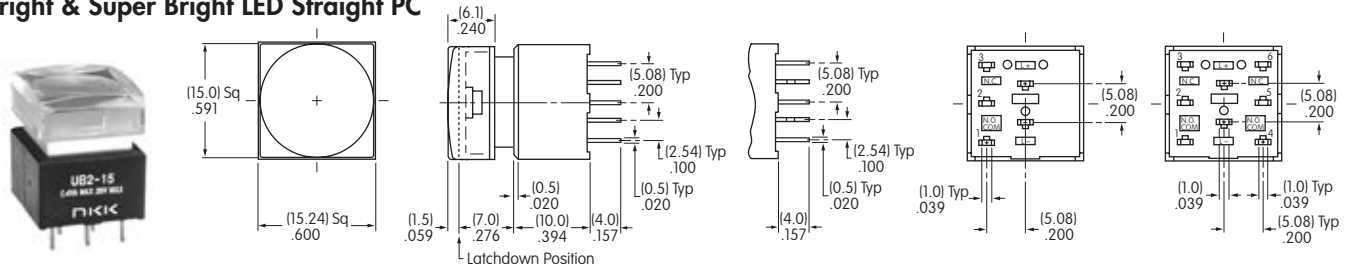

UB215SKG035C-1JC

Bright Single Color LED

Super Bright Single Color LED

Single Pole

Double Pole

Bicolor LED Straight PC

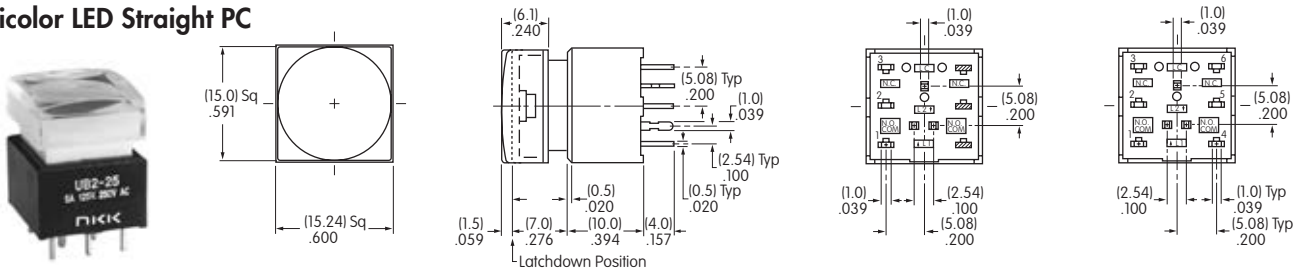

UB225SKG03CF-1JB

Bicolor LED Side View

Single Pole

Double Pole

Bright LED Solder Lug

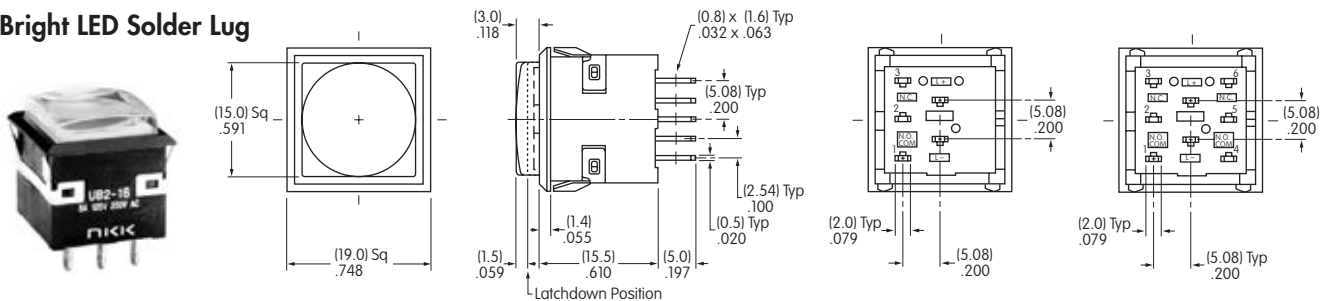

UB216KKW015F-1JF

Single Color LED Side View

Single Pole

Double Pole

Super Bright LED Solder Lug

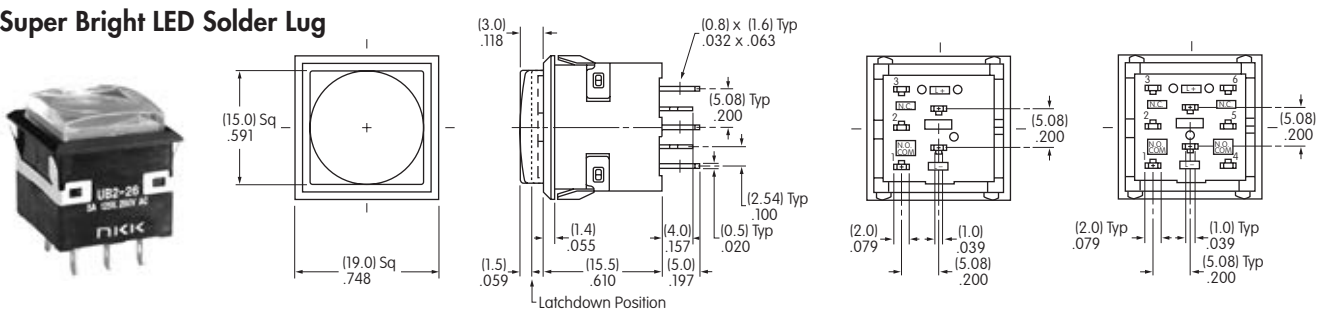

UB226KKW016F-1JF

Single Color LED Side View

Single Pole

Double Pole

Bicolor LED Solder Lug

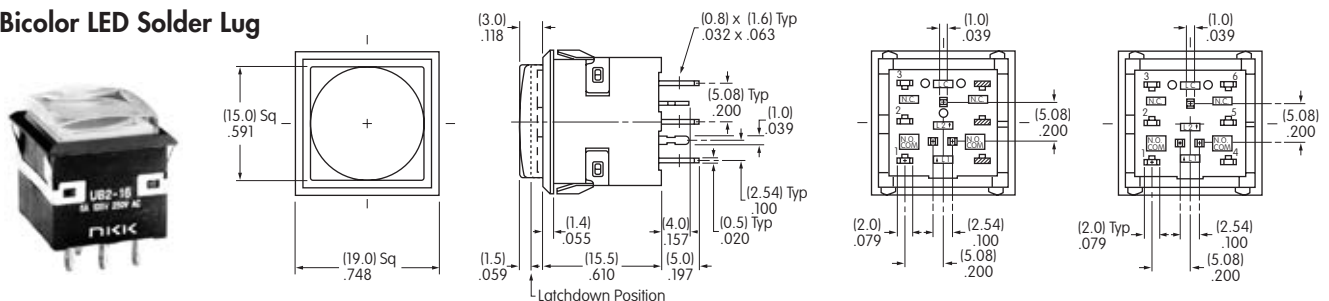

UB216KKW01CF-1JB

Bicolor LED Side View

Single Pole

Double Pole

OPTIONAL ACCESSORIES

Protective Guard for Snap-in Model

AT4141

Opens 90°
Closes manually



Materials:

Cover: Clear Polycarbonate
Base: Black GFR Polyamide

Recommended Panel Thickness:
.039" ~ .106" (1.0mm ~ 2.7mm)

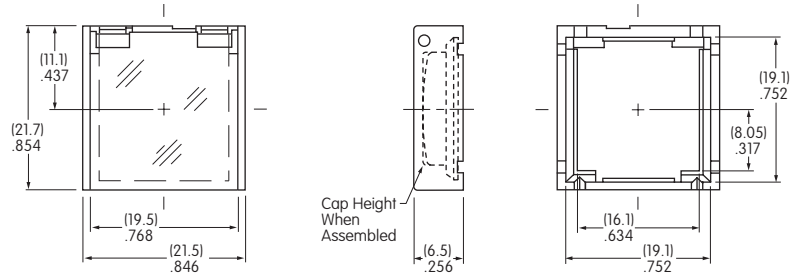

Spring Loaded Protective Guard for Snap-in Mounting of PCB Model

AT4170

Opens 180°
Closes automatically



Materials:

Cover: Clear Polycarbonate
Base: Black Polyamide
Coil Spring: Stainless Steel

Recommended Panel Thickness:
.039" ~ .126"
(1.0mm ~ 3.2mm)

Recommended Panel-to-PCB Range:
.531" (13.5mm)

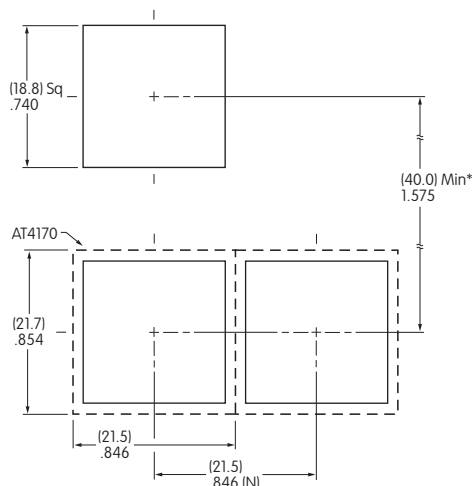
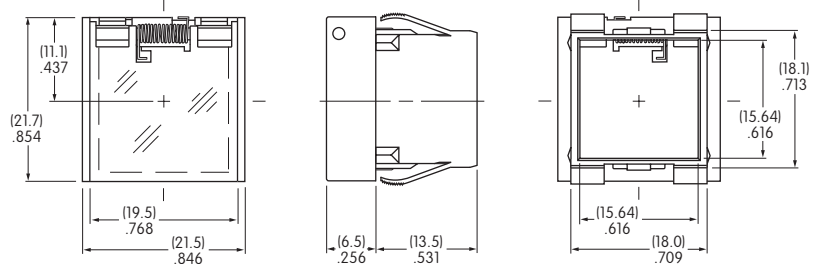

(N) = Number of switches
* Minimum dimension allows opening of cover to 180°

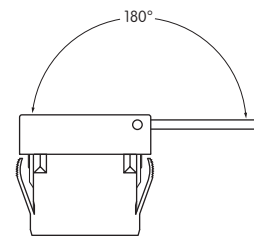
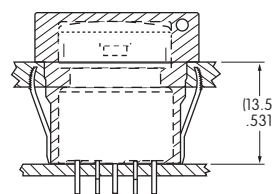

Installation

- 1 Install switch onto PC board.
- 2 Snap protective guard into panel.
- 3 Join the two assemblies.

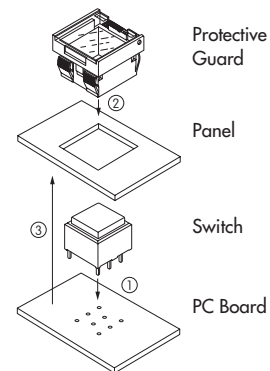

OPTIONAL ACCESSORIES

Spring Loaded Protective Guard for Snap-in Model

AT4142

Opens 180°
Closes automatically



Materials:

Cover: Clear Polycarbonate
Base: Black GFR Polyamide
Coil Spring: Stainless Steel

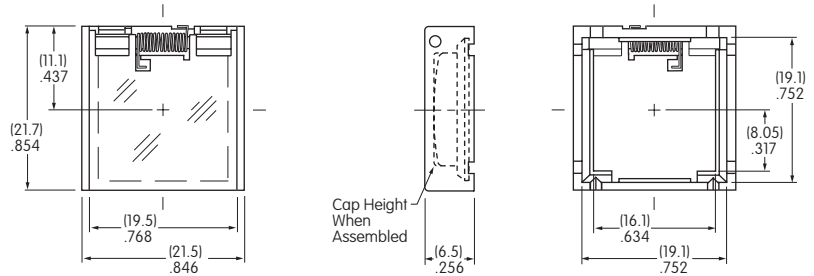

Recommended Panel Thickness:

.039" ~ .106" (1.0mm ~ 2.7mm)

Dust Cover

AT4145 Not for use with barriers.

Materials:

Lid: Clear PVC
Operating temperature range:
0°C ~ +70°C (32°F ~ 158°C).
Gasket: Polyethylene

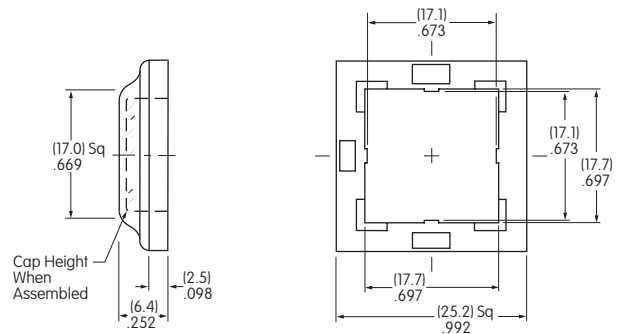
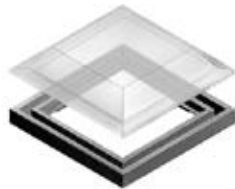

Recommended Panel Thickness

.039" ~ .098" (1.0mm ~ 2.5mm)

Barriers for Snap-in Mount

AT4143 End

AT4144 Center

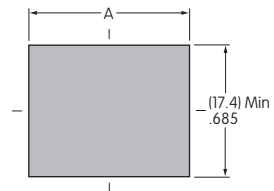
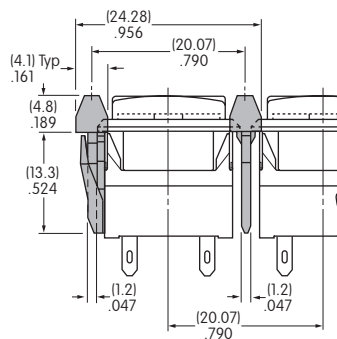
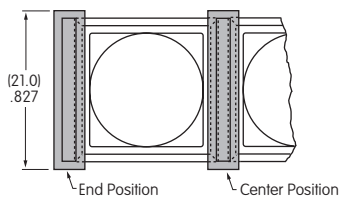

Cutouts for more than 1 Switch:

$$A = .799" (20.3\text{mm}) \times \text{Number of Switches} + .063" (1.6\text{mm})$$

Material: Polyamide

LEGENDS

NKK Switches can provide custom legends for caps. Contact factory for more information.

Suggested Printable Area for UB2 Lens, Film Insert or Diffuser

Recommended Methods: Laser Etch on clear lens, Screen Print or Pad Print on lens;
Laser Print on film insert.

Shaded areas are printable areas.

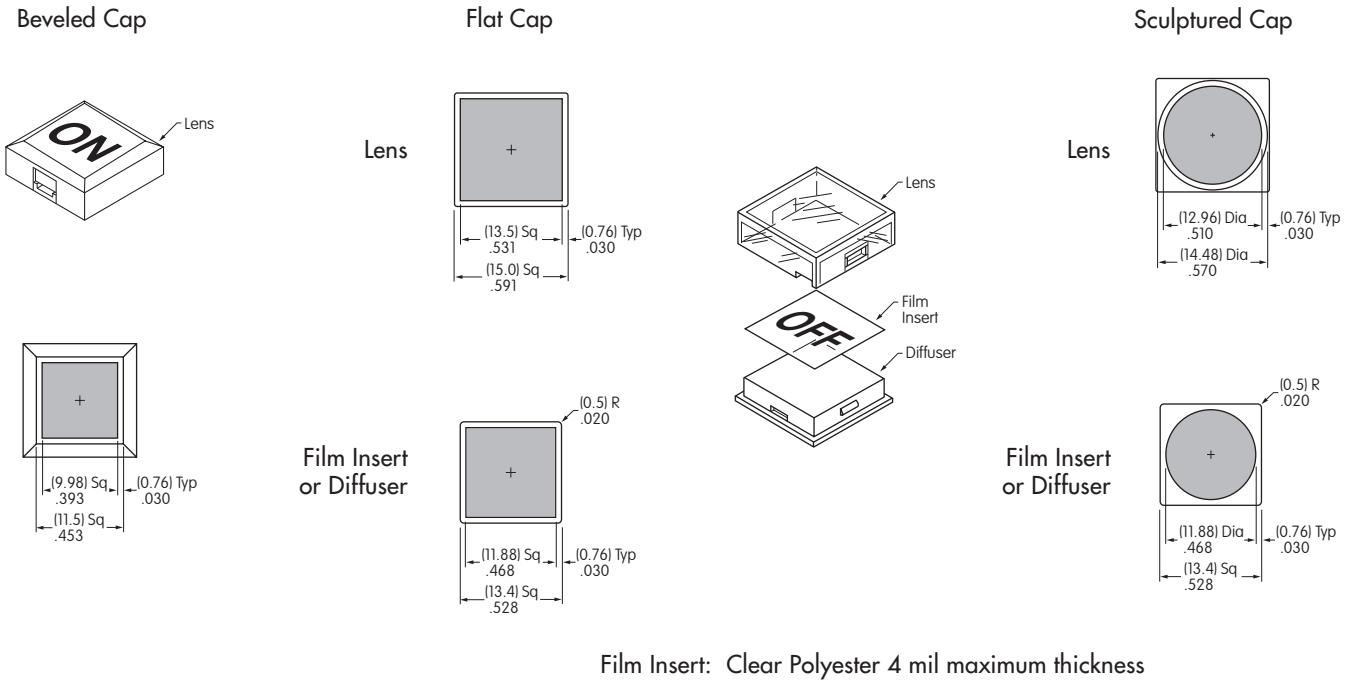

Toggles
Rocker
Pushbuttons
Illuminated PB
Programmable
Keylocks
Rotaries
Slides
Tactiles
Tilt
Touch
Indicators
Accessories
Supplement

Mouser Electronics

Authorized Distributor

Click to View Pricing, Inventory, Delivery & Lifecycle Information:

NKK Switches:

[UB215SKG035F-1JF](#) [UB215KKG015F-1JB](#) [UB216SKG035D-1JB](#) [UB215KKW015D-1JD](#) [UB215KKW015D-1JB](#)
[UB215SKG035C-1JB](#) [UB216KKW016F-1JB](#) [UB215KKW016G-1JB](#) [UB225KKW016F-1JB](#) [UB226KKG016G-1JB](#)
[UB225KKW015D-1JD](#) [UB225KKW015D-1JB](#) [UB226KKW016B-1JB](#) [UB225KKW016B-1JB](#) [UB225KKW015F-1JB](#)
[UB225KKW015F-1JF](#) [UB215SKG035D-1JB](#) [UB216KKW016G-1JB](#) [UB226KKW016F-3JF](#) [UB225KKG016F-3JB](#)
[UB225KKW016G-1JB](#) [UB226KKW016G-1JB](#) [UB215KKW015C-1JC](#) [UB215KKW015D-3JB](#) [UB215KKW015F-1JB](#)
[UB215KKW015F-1JF](#) [UB215KKW016B-1JB](#) [UB216SKG035C-1JB](#) [UB216KKW015D-1JB](#) [UB216KKW015D-1JD](#)
[UB226KKW015F-1JB](#) [UB226KKW015F-1JF](#) [UB225KKG015C-3JB](#) [UB216KKW015C-1JC](#) [UB216KKW015C-1JB](#)
[UB216KKW016B-1JB](#) [UB226KKW015D-1JB](#) [UB226KKW015D-1JD](#) [UB216KKW015F-1JF](#) [UB216KKW015F-1JB](#)
[UB225KKW015C-1JC](#) [UB225KKW015C-1JB](#) [UB226KKW015C-1JC](#) [UB226KKW015C-1JB](#) [UB226KKW016F-1JB](#)
[UB215KKW016F-1JB](#) [UB226SKG036CF-4J01](#) [UB216KKG016CF-4J02](#) [UB226KKG016CF-4J04](#) [UB226KKW016CF-4J04](#)
[UB216SKG036CF-5J02](#) [UB226KKW016CF-5J02](#) [UB226KKW016CF-4J02](#) [UB226KKW016CF-5J04](#)
[UB216SKG036CF-4J01](#) [UB226SKW036CF-4J01](#) [UB226SKG036CF-5J01](#) [UB216KKW016CF-5J02](#)
[UB216SKG036CF-5J04](#) [UB216KKG016CF-4J01](#) [UB216SKG036CF-4J02](#) [UB216SKG036CF-4J04](#)
[UB216SKW036CF-5J02](#) [UB226SKG036CF-5J02](#) [UB226SKG036CF-5J04](#) [UB215KKG015F](#) [UB215KKG016CF](#)
[UB215KKW016CF](#) [UB215SKG036CF](#) [UB215SKW036CF](#) [UB216KKG016CF](#) [UB216KKW016CF](#) [UB216SKG036CF](#)
[UB216SKW036CF](#) [UB216SKW036F](#) [UB225KKG016CF](#) [UB225SKG036CF](#) [UB225SKW036CF](#) [UB226KKG016CF](#)
[UB226KKW016CF](#) [UB226SKG035D](#) [UB226SKG036CF](#) [UB226SKW036CF](#) [UB215SKG036G-1JB](#)
[UB216KKW016CF-4J02](#) [UB226SKW036CF-5J01](#) [UB215KKG016CF-4J01](#) [UB215KKW016CF-4J02](#)
[UB215KKW016CF-5J01](#) [UB215KKW016CF-5J02](#) [UB215KKW016CF-5J04](#) [UB215SKG036CF-4J01](#)
[UB215SKG036CF-4J02](#) [UB215SKG036CF-4J04](#) [UB215SKG036CF-5J01](#) [UB215SKG036CF-5J02](#) [UB215SKG036CF-5J04](#)
[UB215SKW036CF-4J01](#) [UB225KKG016CF-4J01](#) [UB225KKG016CF-4J02](#)